



Star EV Sirius Service Manual

V1.04



STAR

Contacts to know

Star EV Technical Support **864-549-7224**

Robby Dickens: Technical Support Manager

Jonathan Torres: Technical Writer

Kevin Ayers: Technical Support

Terry Hu: Electrical Engineering

Shannon Powell: Warranty Specialist

www.starev.com

Foreword

Hi there folks! This is Jonathan, from the Star EV technical support team! I've been given the monumental task of writing this service manual for the Star Sirius vehicle for you, our dedicated dealers and service techs.

There are a few things I hope to convey through this manual:

- First, I hope you can feel how seriously we take your jobs, livelihoods and families. We've talked with so many of you on the phones, and have come to know you not only on a technical/business level, but on a personal level as well!
- Second, we want you to know that we are here to reduce your stress as much as possible. The easier we can make your job, the better your life will be. Also, it helps you move on to the next job quicker, and keep your customers happier. And this helps everyone involved!
- Third, I've tried to keep things simple and straightforward. When you need information, you don't want to search for hours. And I know that. You need the help right away, with simple testing that will narrow down the problems fast. We value your time, and know there isn't any that you can waste.

And beyond this, we just want to thank YOU for all your hard work!! Without you guys, slogging it out in the trenches, day in and day out there would be no need for us. There would be no need for this company, or even a service manual at all! So I thank you again, for all you do!

Please bear in mind that this is an ever-expanding document. Updates will be added, and refined as time goes on, and we hope that you will see this as ongoing responsiveness to your requests! Thank you for giving us this opportunity to serve and work alongside you!

Table of Contents

Component Locations	5
Identification Locations	6
Lift Points	7
Maintenance Points	8
Maintenance Intervals	9
Necessary Tools List	10
2P Component Locations	11
4P Component Locations	13
Fuse Assignments	15
Care and Maintenance	16
Body	27
Motor	77
Sensors	80
Charger	99
Batteries	120
Controllers	169
Converter	212
Brakes	217
Steering & Suspension	258
Drivetrain	294
Body Electrical	307
Basic Voltmeter Testing	354
Torque Specifications	362
Glossary	364
Table of Tables	365
Index	366

Component Locations

Fluids and Capacities

Component	Fluid Type	Capacity
Brake Master Cylinder (4 and 4+2)	DOT 3 Brake Fluid	To fill line on reservoir
Rear Differential	75W/90 GL-5 Gear Oil	21oz. or .65L

Bulbs and Lighting

Light Type	Bulb	Serviceable
Headlight	N/A	No
Brake Light	N/A	No
Running Light	N/A	No
Reverse Light	N/A	No
Turn Signals	N/A	No
Interior Dash Light	N/A	No
License Plate Illumination	N/A	No
Dash Buttons	Non-illuminating	No

Lift Points

2P Lift Points

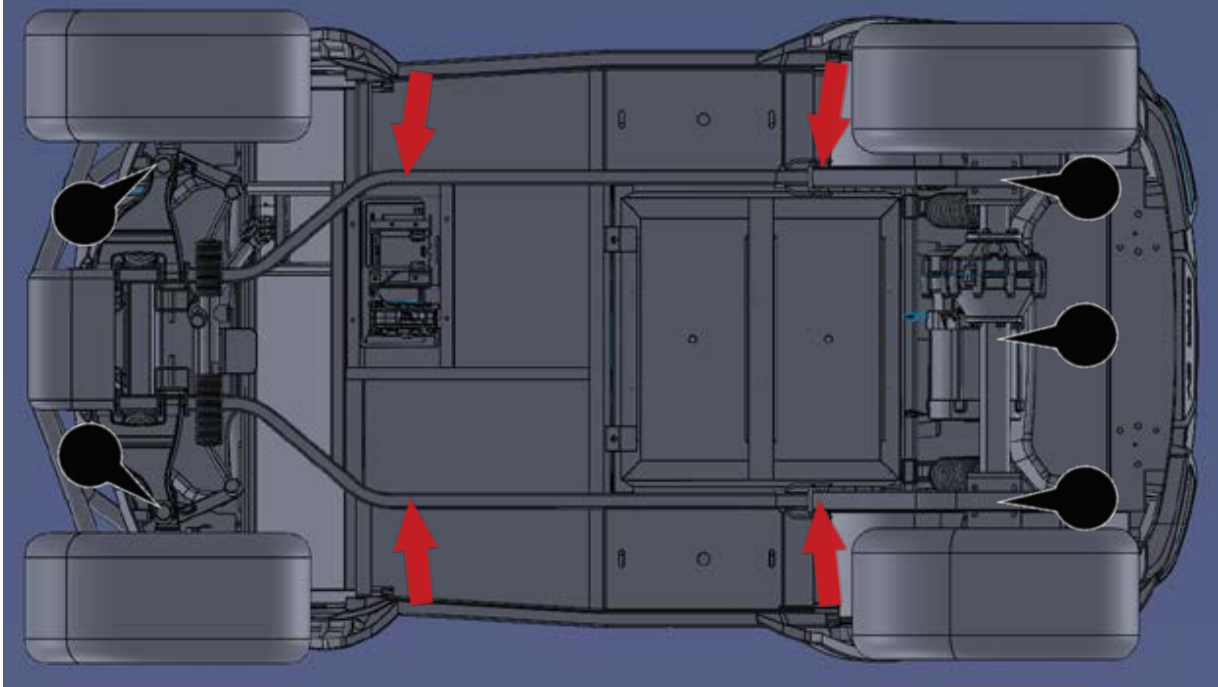

4P Lift Points

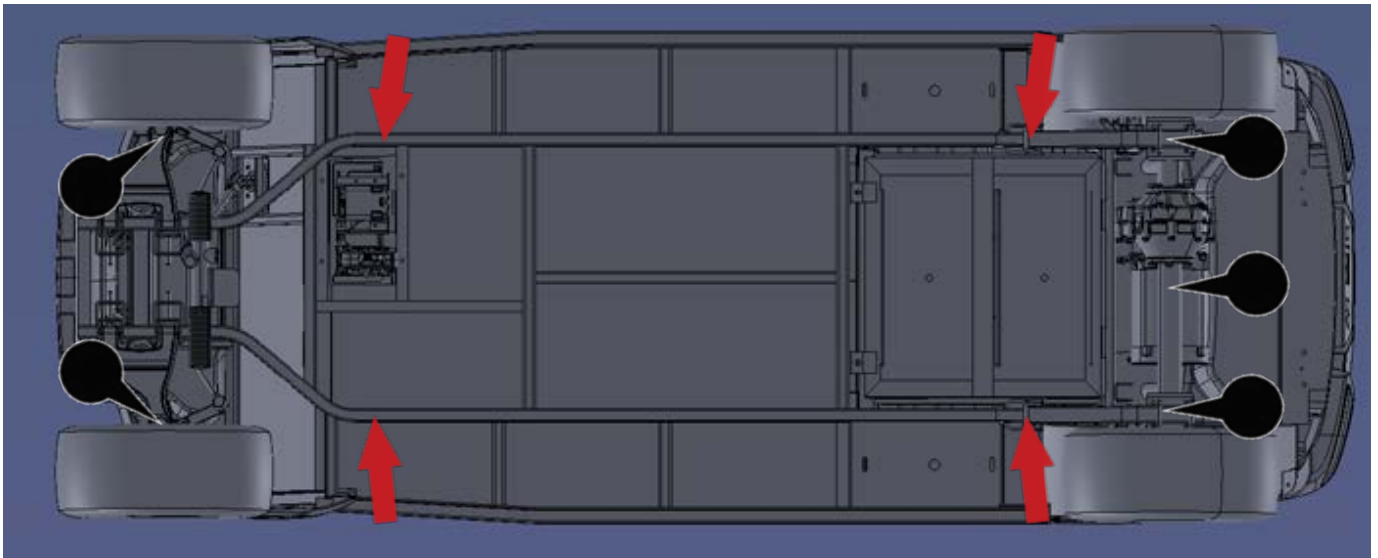

Jack Lift Points







Jack or Lift Lift Points



Watch: How to put a vehicle on the lift safely

Maintenance Points

Tire Types	Air Pressure (in PSI)
Lifted and Non-lifted	20PSI

Grease Points	
Upper and Lower Ball Joints	
Trailing Arm Bushings	
Steering Intermediate Shaft	
Front Wheel Bearings (2 and 2+2)	

Maintenance Intervals

	Component(s)	1 month or 150 miles	900 Miles	1800 Miles	2700 Miles	3600 Miles
Electrical	Check battery cable torque	√	√	√	√	√
	Check and adjust sealed lead acid water level-distilled water only	√	√	√	√	√
	Check for lithium BMS updates-lithium batteries only			√		√
	Check light operation	√	√	√	√	√
Tires/Alignment	Check wheel nut torque	√	√	√	√	√
	Rotate tires and inspect for uneven wear		√	√	√	√
	Check and set alignment			√		√
Brakes	Check front brakes (thickness, uneven wear)			√		√
	Check rear brakes and lubricate slides	√	√	√	√	√
	Re-pack front wheel bearings and re-torque			√		√
	Flush brake fluid					√
	Check and adjust brake fluid level	√	√	√	√	√
Frame/Suspension	Grease lubrication points		√	√	√	√
	Check U-bolt torque	√		√		√
	Replace rear differential gear lube					√
	Check roof support bolt torque	√	√	√	√	√
	Inspect rubber boots and bushings		√	√	√	√
	Check frame welding and rust			√		√

Necessary Tools List

Maintenance

Bearing Packer
Grease Gun
Zip ties of various sizes
Tire Tread Depth Gauge
Tire Pressure Gauge

Basic Service

Jack
Jack stands
Dead man stand
Impact guns (3/8" and 1/2")
1/4" and 3/8" Metric deep socket set
1/4" and 3/8" Metric shallow socket set
1/4" and 3/8" drive extensions
Pliers set
Screwdriver set
Metric Allen wrench set
Metric Allen socket set
Pick tool set
Pry Bar Set
Laptop (intel or AMD)
Drill
Drill Bits
Dead Blow Hammer Set
Ball Peen Hammer Set
3/8" Torque Wrench
1/2" Torque Wrench
Work Light
Plastic Trim Removal Tool
Inspection mirror(s)
Mechanic's Stethoscope
Chassis Ear Tool

Body

Rivet Gun
Large Rivet Gun
Pop Rivets various sizes (black also)

Brakes

Vacuum Brake Bleeder
IR Thermometer
Drum Brake Micrometer
Pneumatic Air Operated Brake Bleeder with Auto-Refill Kit
Flare Nut Wrench Set
Wire brush
Silicone brake grease
BG Stop Squeal
CRC Disc Brake Quiet

Steering/Suspension

Spanner Wrenches
Caster Camber Gauge

Drivetrain

90° Snap Ring Pliers
Slide Hammer with Axle Hub Puller

Electrical

Discharge machine
100 Amp 6-12V Battery Load Tester
Curtis handheld (with a 4 after the dash in the S/N)
135 Amp 6-12V Battery Load Tester
MCX CAN Adapter and software
Lithium CAN box adapter kit
Smartphone
Digital Volt Ohm Meter
Voltmeter Test Lead Kit
3' Jumper Wires
6' Jumper Wires
2CH971 External Trickle Charger
DC Amp Meter-Clamp on style
Battery Electrolyte Tester

Soldering Gun with Solder
Wire Strippers/Cutters
Solder-seal connectors
Wire Crimpers
Crimp-on electrical connectors
Wire Terminal Crimpers
Electrical Tape
Terminal De-pinning Tool Set
Battery Lift Strap
Heat Gun
Heat Shrink Tubing-various sizes
Wire Loom-Variou sizes

Cleaning/Protecting

Goo Gone
Wax and Grease Remover

2P Component Locations



Lithium Short Car



Lead-acid Short Car

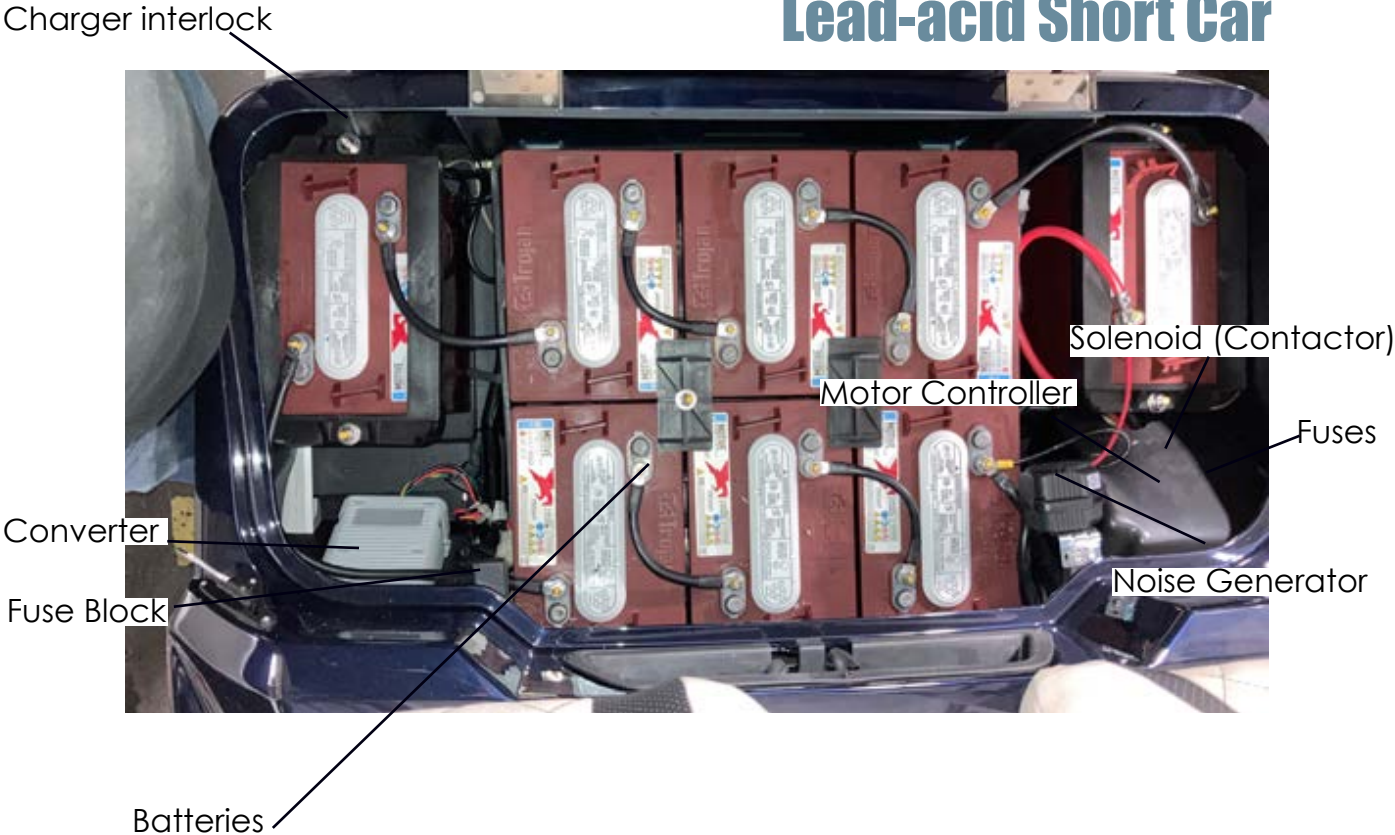

4P Component Locations

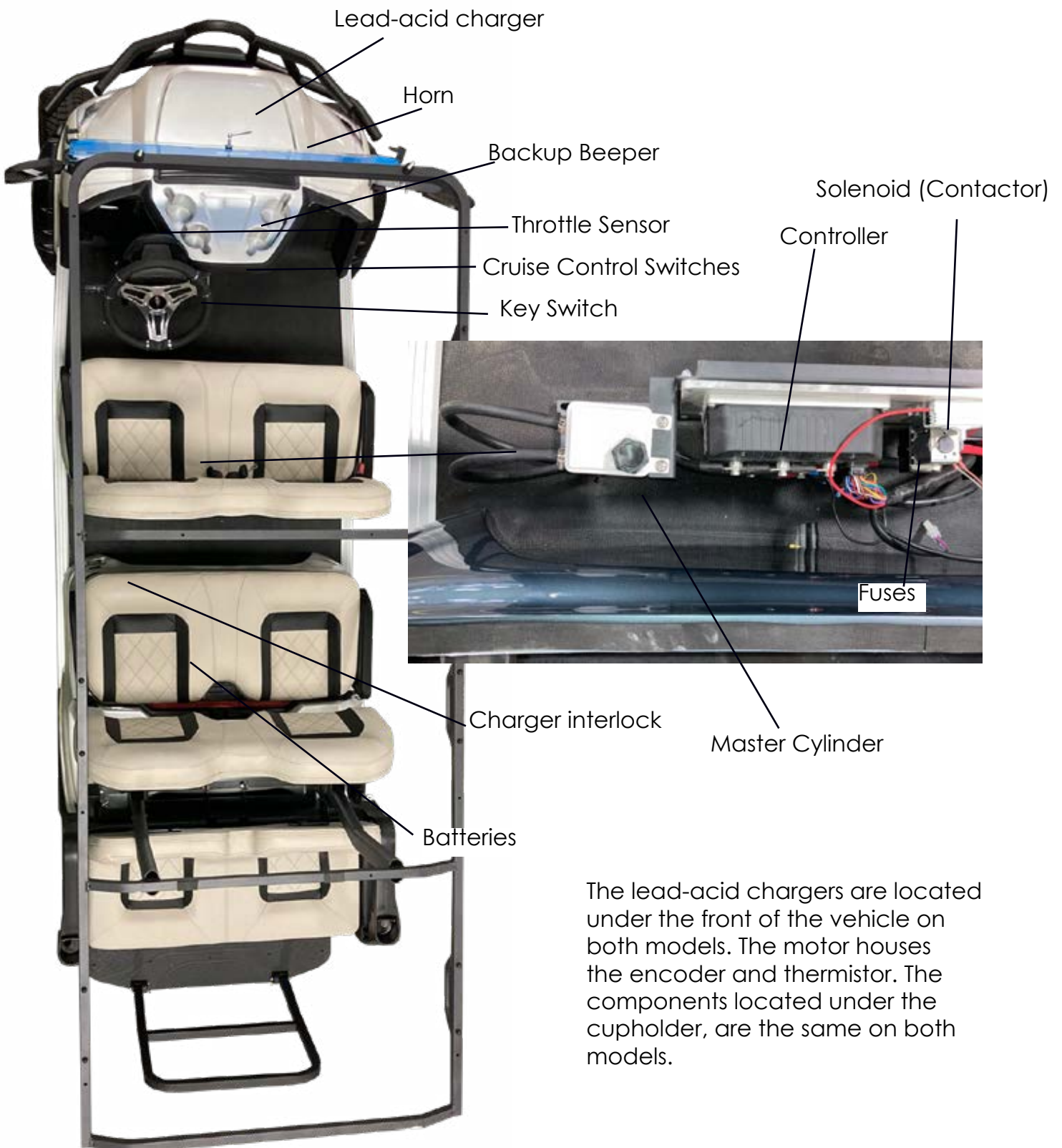

The lead-acid chargers are located under the front of the vehicle on both models. The motor houses the encoder and thermistor. The components located under the cupholder, are the same on both models.

Lead-acid Long Car

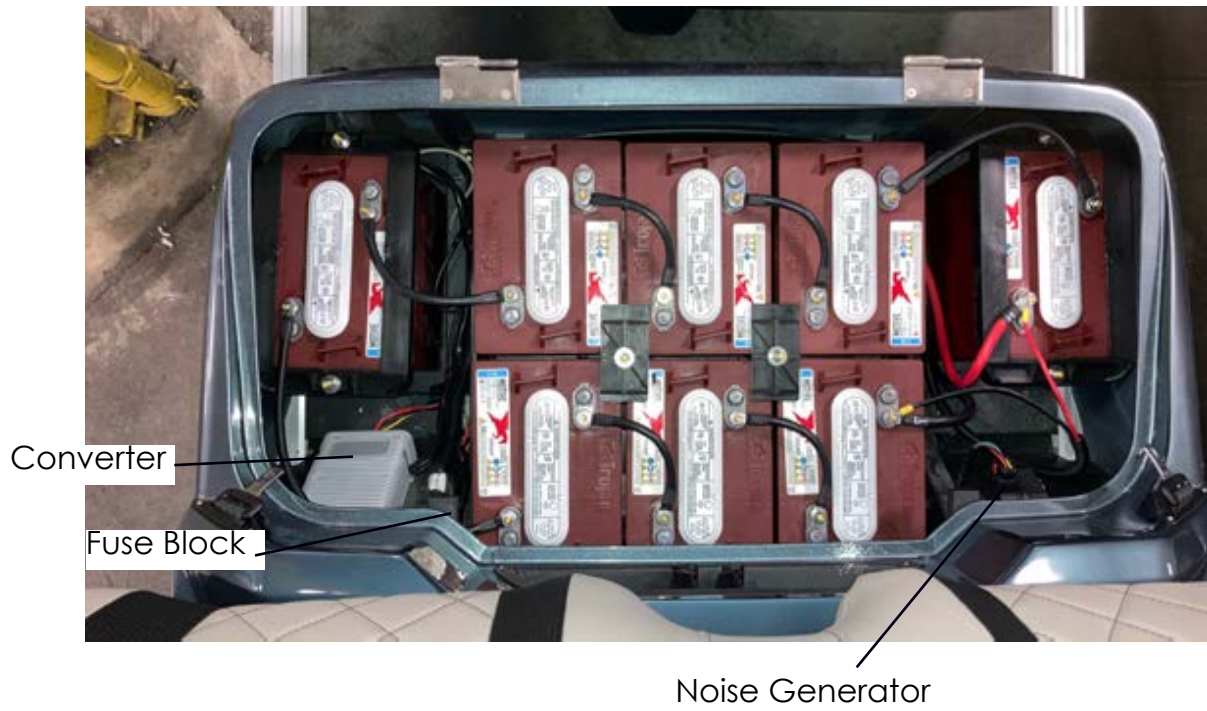

Lithium Long Car



Fuse Assignments

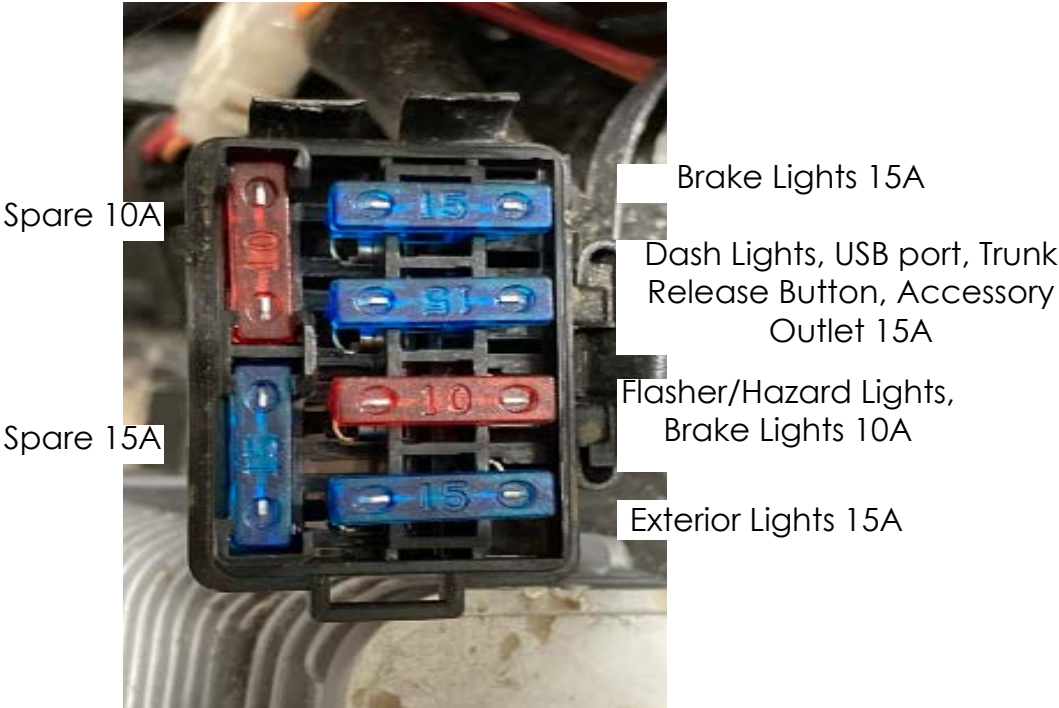

Care and Maintenance

For general exterior care, immediately remove any corrosives that may have come in contact with the vehicle. These can include, but are not limited to tree sap, eggs, bird droppings, tar, dead bugs, winter road salts, construction fallout such as sand or demolition silt. Use denatured alcohol to remove tar or grease stains, and then quickly use a non-detergent soap to remove the alcohol left behind.

For washing, begin by flushing away any grime, sand, dust or mud from the vehicle as a preliminary rinse. Use a gentle hose. You can also use this hose to rinse off any salts that have accumulated on the underside of the vehicle, frame, brakes, etc. Using a clean soft cloth or car washing mitt, wash the painted surfaces of the vehicle with mild, soapy water or high-quality car shampoo. Use cold or lukewarm water for this step.

Rinse the vehicle with clean water after washing. Dry with a chamois. You can dry the brakes by going on a short drive and applying the brakes periodically.

The main things to keep in mind are:

1. Don't pressure wash the batteries. Do not use any water on or near the battery.
2. Do not pressure wash or put water inside the battery charging port.
3. Don't pressure wash the steering column or dash display(s).
4. You can use isopropyl alcohol to clean the display screens if needed.
5. If the vehicle gets a scratch, touch-up paint is available in matching colors.
6. Seat care: see seat section
7. Use a golf cart cover, if leaving your vehicle outside for an extended time. If your vehicle is normally kept outside, there may be a risk of mice or squirrels chewing on the wiring insulation so it is recommended that the vehicle wiring harnesses be inspected periodically for any damage.

Seats & Seating

Care and Cleaning

One of our most frequently asked questions, is how to clean marks from seats. There is a delicate balance between removing the marks from the seats, and damaging or fading the seat material. What we have found is that most marks will respond well to a general wax and grease remover. The one shown, is available from an automotive paint supplier, but there are several available from automotive parts stores.

Be sure to use a white automotive style shop rag with these cleaning products, to prevent the cleaner from leeching the rag's color onto the seats making the problem worse.

The next product is Goo Gone. This is the second tool to use, if the first doesn't remove the marks. This product is good for removing substances that are adhesive based, and helps to break down the adhesive so that the substance can be removed. Rubbing alcohol can be used to remove the residue of the cleaners, once they've done their work.

Should these products not work in removing the stains, paint thinner can be tried VERY SPARINGLY. Paint thinner can leave a faded mark in the fabric QUICKLY, so it is not recommended unless everything else has already been tried. DO NOT scrub the seat, when using the thinner! This will increase the speed at which fading can happen.

One thing that is almost impossible to remove from the seats, is rust. You can try the above methods, but you may have very mixed results. If the rust will not come off, you will need to replace the seat cushion to get rid of it.

For protecting the seats, a vinyl protectant, with UV protection is recommended. This is a product that is usually used for boat seats, due to their high level of sun exposure.



Seating Options



The Sirius vehicle has a folding lower seat cushion, which folds forward on two hinges at the leading edge. This style folding seat is used on the forward facing seats.



Each seat is equipped with a lap seatbelt, which locks into a buckle toward the center of the vehicle. Each seatbelt component can be replaced independently, as needed.



There is a small lip, at the front edge of the seatbelt pocket at the back of the front seat on 2 passenger, or the rear seat on 4 passenger. This lip is used for propping up the seatbelt clasps so that the seat can be raised easier, without the clasps in the way.

Installing a Rear Flip-seat



To remove the sweater basket, you will need a 5mm Allen socket, with ratchet and a 13mm wrench. For the flip-seat installation, you will need a drill with 3/8" drill bit, an impact wrench, ratchet, 10mm wrench, 10mm socket, 13mm wrench, 13mm socket, 17mm wrench, 16mm socket, 5mm Allen socket and Phillips screwdriver or bit.



Your kit will arrive as shown. The main box has all the components you will need for the installation, **except the cooler lower "bucket" and the seatbelt bar with seatbelts. These parts will need to be ordered separately.**



For installing the seatbelt bar, you will need 4 M8x25 SS Button Head Allen bolts, 2 M8x70 SS Button Head Allen bolts, 4 M8 Flat Fender Washers, 8 M8 SS Flat Washers, and 6 M8 SS nylon nuts. You will also need 4 black Phillips self tapping screws to install the cooler bucket.



Start by using the 5mm Allen socket and 13mm wrench to remove the four bolts that secure the sweater basket to the rear roof supports. Pull the basket out and away from the roof supports to remove it from the cart.



Locate the flip seat backrest frame. This is the part that will go between the rear roof supports. In the hardware kit, for the seat kit, you will find two foam rubber pads with self adhesive backing. Expose the adhesive and attach one pad on each corner of the frame where the frame will contact the rear roof supports.

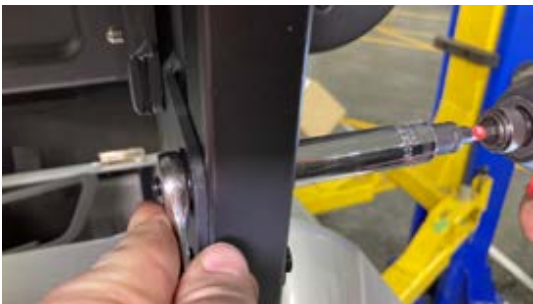

Following the installation instructions in the kit, you will find and install 4 black bolts with black flat washers through the seat back frame and the large tabs on the roof supports. Do not fully tighten these bolts, so that you can maneuver the rest of the kit into place to align all the bolts before final tightening.



Moving to the lower section, you will locate the lower section of the seat frame. This is the part that will bolt to the bottom of the cart, and will receive the footplate and lower components.



From the underside of the vehicle, you will see that the slotted holes in the lower section of the seat kit, line up with two holes under the golf bag well. You will use the drill and 3/8" drill bit to drill upward, through these two holes, and through the bag well.



The drill bit will pass completely through the bag well, so that the bolts can pass through and attach the seat base to the cart.

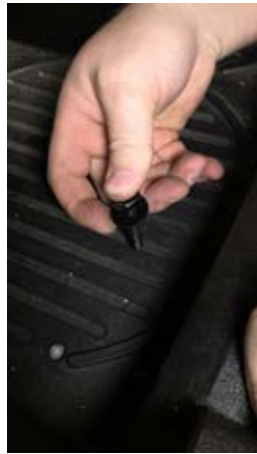

Locate the large bolts in the seat kit's hardware kit. Attach a flat fender washer and install into the holes that were just drilled through the bag well. You will tighten these bolts, but not fully tight. These bolts will be tightened using the 17mm wrench and 16mm socket.



Locate the two seat armrests. You will notice that there are two rectangular openings at the base of each "leg". These openings are for installing the captive nuts. You will use the four square nuts from the hardware kit, to fill these holes. Use a small screwdriver and hammer to seat the nuts fully into their openings.



Install the armrests into the flip seat bottom. Be sure that the captive nut openings face toward the outside of the seat. If this is reversed, the seat bottom flip section won't be able to clear the curve of the armrest. Placing the captive nut opening facing out, will ensure the curved side of the armrest also faces outward.

Install the longer M6 bolts with flat washers and lock washers into the seat base holes, going into the front armrest holes, with the captive nuts in them.



Install the shorter M6 black bolts with lock washers and flat washers, into the front seat base holes, where they go into the rear legs of the armrests. You can tighten all four of the armrest bolts fully at this time.



You will now lift the seat bottom section onto the back of the vehicle. There is a piece of U-channel under the bottom of this seat base, that goes over the lower seat base uprights. You will see there are inserts pressed into the uprights to accept the bolts that will attach this U-channel.

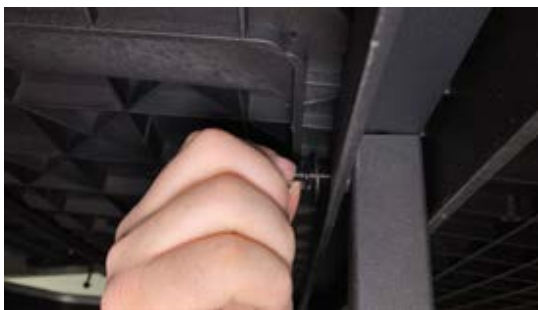

Install the M8 bolts with lock and flat washers into the holes in the U-channel, into the inserts in the uprights. Do not tighten these bolts fully at this time.

Install the longest black M8 bolts into the bolt holes at the very back of the flip seat bottom. You will use the D-shaped washers on the top side, allowing the washers to fit against the ridge at the back of the base. Add M8 nuts with black flat washers below.





You can now begin tightening all the bolts on the entire seat kit thus far. Begin with the 13mm bolts in the U-channel. Tighten these bolts fully.



Now tighten the bolts at the bottom of the golf bag well, using the 16mm socket, ratchet and 17mm wrench.



Use the 10mm socket to tighten the bolts at the rear of the flip seat base. These are the bolts with the D-shaped washers. Use the 10mm wrench to hold the nuts from the underside while tightening.



Now install the footplate, and secure with the black M8 bolts from the kit's hardware kit. You can fully tighten these bolts at this time.



You will now be able to install the rear grab bar. To install the grab bar, you must "hook" the lower end of the bar into the slots in the footplate. The grab bar locks into these slots, and will not attach properly if you don't hook the flanged bolt holes into these slots first.



Using the supplied bolts, you will attach the bottom of the grab bar. These bolt will pass through the flanged bolt holes that you just hooked into the foot plate. The top holes of the grab bar will receive the removable clevis pins. Only the bottom holes use bolts.



Check the flip action of the seat section, to see if it aligns properly with the grab bar. If it needs to be adjusted, slightly loosen the bolts that attach the footplate and pivot the footplate up or down until the seat floor fits correctly within the grab bar. Re-tighten the footplate bolts.



Install the cooler “bucket” with the notched edge pointing toward the cooler lock. Secure the “bucket” with four black self-tapping screws.



For the universal seat cushions, you will need 4 black M6x25mm bolts with four M6 black flat washers and four M6 black lock washers. These bolts will secure the seat back cover to the seat back cushion.



Using a ratchet and 10mm socket, you will install and tighten these bolts into the seat cushion back cover.



Using the supplied hardware, you will attach the seat backrest brackets. Install these brackets so that the slotted hole is toward the edge of the seat that will be facing down when installed onto the cart. Don't fully tighten these bolts at this time.

Inside the upright tubes at the back of the flip seat back, you will see that the plastic end caps cover half of the mounting bolt holes. These caps will prevent your bolts from going through the tubes properly. Use the 3/8" drill bit and drill to drill through these holes and clear the path for the bolts.



You can now install the bolts that attach the seat back assembly to the flip seat uprights. You will tighten these bolts fully, before tightening the bolts that attach the seat back brackets to the back of the seat cushion. You will also fully tighten the bolts that secure the seat back frame to the rear roof supports.



Using the SS M8x25mm Button Head Allen bolts, flat washers and nylon nuts, attach the seat belt buckles to the center tabs of the seat belt bar. Leave these bolts slightly loose until the bar is installed into the flip seat.



Use the rest of the M8x25mm bolts to attach the seat belt retractors to the ends of the seat belt bar. You will leave these bolts slightly loose as well, so that you can adjust the positioning once the bar is installed.



Using the M8x70mm bolts, washers and nylon nuts, you will secure the seat belt bar to the assembled flip seat.



The flip seat is now installed and ready for use.

Body

Model	Star EV Standard Color	Paint Code
Sirius 2 Passenger, 2+2, 2+2 Lifted, 4, 4+2, 4+2 Lifted	Carbon Flash Metallic	WA501Q
	Indigo Blue	LZ5E
	Light Argent Metallic	9S
	Ocean Mist Metallic	B530M
	Phantom White	960
	Torch Red	322
	White Diamond Pearl	WA800J
	Soul Red	46V
	Orange	FM
	Bright Teal	L6518
	Purple Metallic	P3283
Model	Star EV Limited Edition Color	Paint Code
Sirius 2 Passenger, 2+2, 2+2 Lifted, 4, 4+2, 4+2 Lifted	Basque Red Pearl	R530P
	Desert Bloom Metallic	WA928L (Water Based)

Seat Back Removal	35
Seat Pod Replacement	37
Seat Belt Removal	41
Golf Bag Holder Installation	43
Tag Bracket Installation	48
Brush Guard Installation	49
Headlight Replacement	51
Hood Latch Cable Replacement	54
Hood Replacement	58
Folding Windshield Replacement	60
Glass Windshield Installation	62
2P Roof Replacement	64
2+2 and 4+2P Roof Replacement	65
2+2 and 4+2P Roof Halo Replacement	66
4P Front Roof Support Replacement	67
Replacing the Tail Light	76

Front Body Remove and Install



To remove the front body, you will need a trim pry bar tool, Phillips screwdriver, ratchet, extension, 16mm socket, small pair of snips, 10mm wrench, 13mm wrench, and 5mm Allen socket.

For replacing the front body, you will need to refer to our section on removing the roof, with halo, windshield and front roof supports. Also remove the black louvered trim below the windshield. You will find there are three Phillips screws under the louvered trim, that hold the dash to the front body. There are 10mm nuts on these screws. Keep the metal trim strip that is above these nuts. These will all need to be out of the way, before starting work on the front body.

Now you will remove the four Phillips screws along the top of the dash, where the dash mates to the front body. Two of the screws are above the glove box and two are above the steering column.



You will find a Phillips screw on each side of the vehicle, where the front body attaches to the rocker panel. Remove these two screws.

Using a plastic trim pry bar, you will pry between the dash and the front body seam. Separate the front body tabs from the dash. Repeat this on the other side also.





Disconnect the trunk release cable from the trunk latch.

Reaching inside the front trunk area, you will disconnect the wiring from the electric trunk release.



You are ready to pull upward and out, on the front body. You may need an assistant to help with removal.

Reaching under the front body, disconnect the wiring for each of the headlights.



These steps are also necessary for replacing the front foam insert. This is also the front cooler basin.



You will need to transfer the headlight assemblies to the new front body. Use a 10mm wrench to remove the four retaining nuts from each headlight assembly.



Use a 12mm wrench to remove the bolts that attach the trunk latch. There are two bolts on each side of the latch.



Using a Phillips screwdriver, remove the two trunk lid hinge screws. Usually the nuts will hold in place automatically, but if they don't, you can hold them with an 8mm wrench.

Transfer the trunk lid to the new front body, as well as the front trunk weather seal. When you have all of these parts transferred, you are ready to reinstall the front body on the vehicle. Reverse the steps of removal, to complete the process.



Dash Remove and Install



To remove the dash, you will need to have a drill with a 13/64" drill bit, ratchet with extension, plastic trim pry bar, 16mm socket, Phillips bit, small and large Phillips screwdrivers, 10mm wrench and a small tool such as a 1/4" socket or terminal tool for compressing the circular locking tabs on the back side of the dash switch panel.



Beginning on the passenger side of the dash, inside the glove box, remove the round access plug beside the hood release lever. Through the access hole, remove the retaining nut that holds the hood release cable. Remove the cable from the hood release lever, and set the lever aside.



Remove the wiring cover from the side of the steering column.

Pull upward on the rubber boot at the base of the steering column and slide it up the column tube.





Using a ratchet with 16mm socket, remove the mounting bolts from the bottom of the steering column. Once these are removed, you will let the column tilt down and rest on the seat



Along the edge of the outer dash, where it meets the floor, you will find two rivets on each side of the cart. Drill out these rivets with a 13/64" drill bit. There will be 4 rivets in all, two on each side.



Using the same drill and bit, drill out the two rivets at the bottom of the center of the dash, below the cupholder area.



Using a Phillips screwdriver or screwdriver bit, remove the four Phillips screws from the upper edge of the dash, two on each side of the cart. These are located above the glove box area, and the opposite side above the steering column.



Using a plastic trim removal tool, you will pry upward on the center dash cupholder, releasing the plastic tabs that hold it in the vehicle. Also remove the black, plastic louvered cowl trim by prying it upward to release its tabs.



Using a Phillips screwdriver and 10mm wrench, remove the three center screws that attach the dash to the front body. There will be a thin metal strip that goes below the dash plastic and acts as a large thin washer. Keep this metal strip for reinstallation later.



Using a small socket, or round terminal tool as shown here, compress the four round tabs that secure the center dash switch panel into the dash. Pull from the front of the switch panel, while compressing the tabs. The tabs will push through the dash and release the panel.



After freeing the switch panel, you will pull outward and twist the panel so that it will slide into the panel hole in the dash. This will keep all the switches in the panel, and all the wiring connected.



With a small plastic trim tool, pry at the seam between the dash and the front body. Continue until you have separated all the dash to front body tabs.

Inside the dash, under the cupholder area, you will see the electric hood release switch button. Using a small Phillips screwdriver, loosen the two wire retaining screws to release the two wires from its back.



You will now be able to pull rearward on the dash, until you are able to disconnect the wiring for the interior dash lights. You will find their small, black connectors on each side of the dash.



Disconnect the wiring for each interior dash light. These lights are self-adhered to the dash. In most cases, you will need to order the chrome trim strips and new dash lights whenever replacing the dash.

Seat Back Remove and Install



For removal of the seat back, you will need a 5mm Allen socket, with a ratchet and extension. These tools will be for removing the two seat back brackets. You will move these brackets to the new seat back before reassembly with the vehicle.

Begin by twisting the hand screw knobs on the sides of the seat back. These are the screws that attach the seat back to the vehicle. You will need



an assistant to help on the opposite side, so that the seat back does not fall down and damage the vehicle paint or seat cushion.

Once the four hand screws have been removed, you will be able to pull the seat back out and away from the vehicle. Take care so as not to damage the rest of the vehicle when removing the seat back.



back. Use the 5mm Allen socket, with ratchet and extension to remove the 4 screws that secure the brackets.

You will need to transfer the seat back brackets over to the new seat

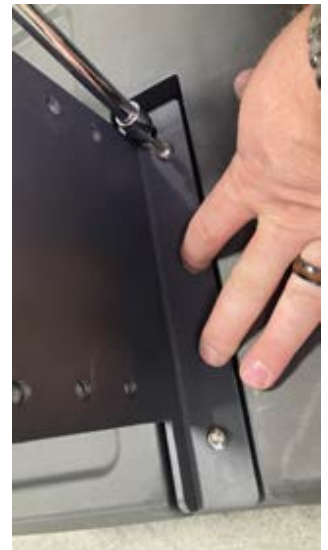



The two brackets will be installed on the seat back, with the longer tab facing toward the bottom of the seat back. The threaded bolting surface of the brackets go inward.

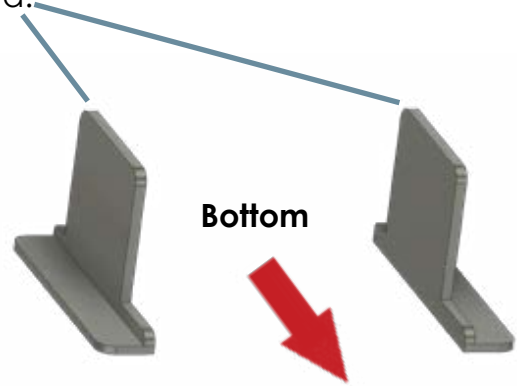

With the help of an assistant, you will install the seat back between the rear roof supports, and install the four hand screws. Tighten the hand screws after they are all started into their corresponding threaded holes in the seat back brackets.

Seat Pod Replacement

For replacing the pod seat, you will need a bit driver with 1/4" bit or 1/4" ratchet with 8mm socket, a 17mm deep socket, two 13mm wrenches, 10mm wrench, a Phillips socket bit, a Phillips screwdriver, a ratchet and a 5mm Allen socket.

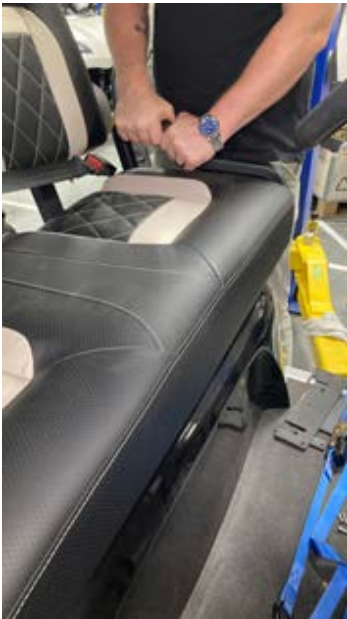

Pull straight up on the lower seat cushion. This will disengage the plastic peg inserts, from below the cushion. Doing this on both sides will release the seat cushion for removal. Remove the cushion and set aside.

Using the bit driver, with 5mm Allen socket, remove the rear seat bracket bolts while holding the lower nuts from below the rear of the seat pod with a 13mm wrench.

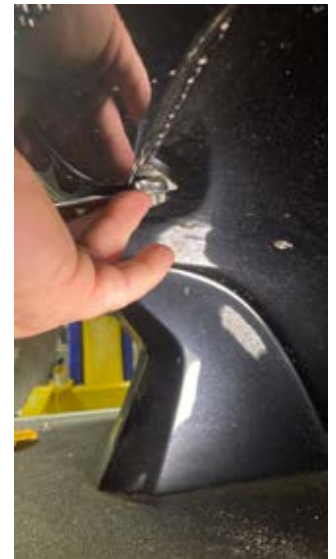



With a 17mm deep socket, and a 13mm wrench, remove the plastic lower cushion locating pin. The socket will go over the pin, while the wrench will hold and remove the nut from the bottom. Capture and retain all hardware for reinstallation later.



Using two 13mm wrenches, remove the two through-bolts at the front of the seat brackets. These are at the front edge of the pod seat. Capture all hardware, for replacement later.

Lift the seat back up and away from the vehicle, being careful not to scratch any painted surfaces.



With the 8mm socket, you will now remove the controller cover nuts. There are four of these nuts in all. Keep these nuts and set aside with the screws. You will hold the screws from the underside with a Phillips screwdriver.



You are now ready to lift and remove the controller cover, to expose the controller.



Disconnect the main battery cables from the battery, to prevent accidental contact with the main leads at the controller.



At the bottom front of the seat pod floor, you will find two 13mm bolts. These two bolts pass down through the pod seat frame feet, into the floor of the vehicle.



Using two 13mm wrenches, you will loosen and remove the two bolts that hold the two rear bolts where they secure the pod seat to the floor. Keep all this hardware for later replacement.



Using a 10mm wrench, remove all cables from the controller connections. Disconnect the 32-pin connector from the controller as well.



Using a Phillips socket bit, remove the screws that hold the controller to its mounting plate. Remove and set aside the controller. Using the Phillips socket bit, remove the screws that attach the controller mounting plate to the pod seat frame. The mounting plate will lay down inside the pod seat floor, loose from the pod seat frame.

Using a Phillips screwdriver and 10mm wrench, you will remove the mounting screws that attach the brake master cylinder to the pod seat frame. You will carefully set the master cylinder aside, being sure it does not tip over. Brake fluid will remove paint from any painted surfaces.



You are now ready to remove the seat pod. You will see that the pod seat frame is intertwined in the pod itself. It is helpful to have an assistant to help pivot and maneuver the pod out from around all the frame and components within the floor area. Replacement is the reverse of removal.

Seatbelt Remove and Install

The 4 passenger vehicle has all the mounting bolts exposed, on the front seatbelt components. For the seatbelt clasp, you can reach the mounting bolt from outside the vehicle. Using an 8mm Allen socket and ratchet, remove the mounting bolt and then the clasp. Reinstall in the reverse order.

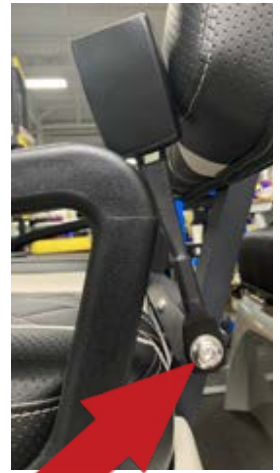

To remove the retractor, you will use the 8mm Allen socket and ratchet to remove the mounting bolt at the center of the front seat. Remove the retractor assembly. Installation is the reverse of removal.

For the two passenger vehicle, all of the mounting bolts are hidden. To begin, you will remove the three Phillips screws that hold the seatbelt pocket, behind the seat. This can be done with the seat in place. If the seat is off of the vehicle, you will want to place an insulating pad on top of the batteries, to prevent damage to the batteries if you should drop a tool onto them.

Once this pocket is out of the way, you will have access to the mounting bolts for the seatbelt clasps.





Using a 16mm socket on a ratchet, and a 17mm wrench, remove the mounting bolt and nut. This is done through the seatbelt pocket hole. Replacement is the reverse of removal.

To access the mounting bolt for the retractors, you will need to remove the wheel and inner fender liner for the side of the retractor you need to replace. Once the fender liner is removed, you will then remove the three Phillips screws from the seatbelt buckle trim. Remove the trim piece and set aside. Push the buckle through the hole that is now exposed with the trim removed.

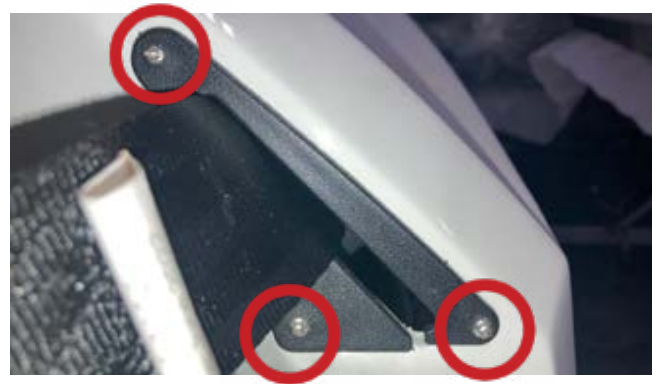

Now, from inside the wheel well, you can access the 15mm mounting bolt for the retractor assembly. This will allow the retractor to fall away from the attachment point. Once you have it out of the way, you will install the new retractor, and its mounting bolt. Place the buckle through the opening in its opening in the body. Once this is pushed through, you will replace the buckle trim piece, with the three Phillips screws.



On the 4 passenger vehicle, this seatbelt configuration becomes the rear seatbelt instead of the front. So you will use this process to replace the rear seatbelt assemblies on 4 passenger vehicles.

Golf Bag Holder Installation



This repair will require a ratchet with a 5mm Allen socket, a ratchet and a 13mm wrench.

You will remove the two Allen head bolts that attach the golf bag holder to the golf bag holder assembly. Use the wrench on the opposite end, to hold the 13mm nuts steady while removing the bolts. Be sure to capture the flat washers along with the nuts and bolts, for reassembly.

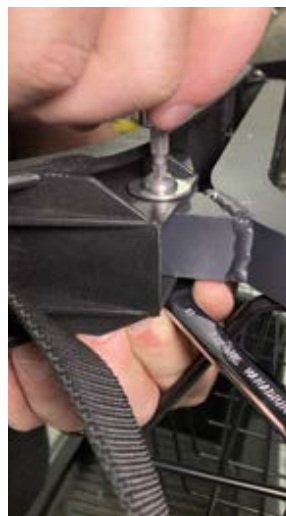

Install the golf bag holder onto the two square tubing risers on the golf bag holder assembly. Install the two Allen bolts, flat washers and nuts. Tighten the bolts securely to complete the installation.

Golf Bag Holder Strap Installation



With a 4mm Allen socket, ratchet, and 10mm wrench, you will be able to remove and replace the golf bag holder strap.

In the center of the golf bag holder strap, you will find a 4mm Allen head bolt attaching the strap to the golf bag holder. There is a 10mm nut on the other end of this

bolt. You will notice there is a hole in the middle of the strap, that allows this bolt to pass through.



Remove the center bolt and capture the flat washers and nut for reinstallation.



Thread the old strap out and through the golf bag holder, going from one end to the other.

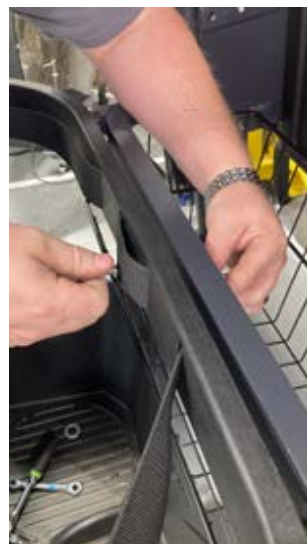



You will thread the new strap through the golf bag holder in the same order that the old strap came out.

Using a drill and a 1/4" drill bit, you will place a hole in the center of the golf bag holder strap. Once this is done, you will install the strap bolt, washers and retaining nut. Tighten the bolt to complete installation.



Golf Bag Holder Basket Installation



To replace the golf bag holder basket, you will only need a ratchet, a 5mm Allen socket, and a 13mm wrench.

Each side of the basket has a mounting bolt and nut holding it to the golf bag holder assembly.



Once the nuts are removed from the bolts, you will be able to lower the basket down from the bolts, for removal.



Lower the basket down so you can carefully remove it from the vehicle. Be sure to capture all flat washers and nuts when removing the hardware from the basket.

Golf Bag Assembly Installation



Using a ratchet, 5mm Allen socket and 13mm wrench, you will remove the four mounting bolts. There are two bolts on each side of the golf bag holder assembly.



Capture and keep all hardware from the golf bag holder assembly mounting bolts. These will be needed, when installing the new assembly.

After all the mounting bolts are removed, you will be able to slide the entire assembly out from between the rear roof supports. Be sure to slide the assembly straight back, so that it doesn't contact the painted surface of the vehicle.

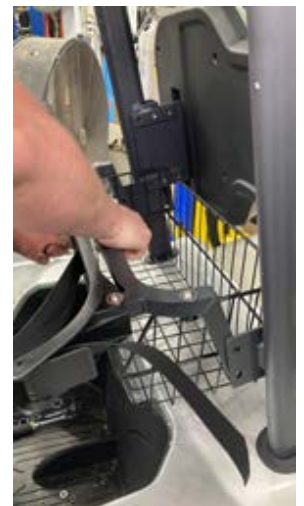

Install the new golf bag holder assembly, and replace all mounting hardware. Tighten the bolts once they have all been installed and their attaching nuts started.

Tag Bracket Installation

When installing the Sirius license plate bracket, with the tag illumination light, great care must be taken when tapping into the vehicle's wiring. If after installing the bracket, the right turn signal doesn't operate properly, or turns on and blinks with the daytime running light, recheck to make sure the wiring was installed correctly. In the example photo, the black wire from the tag light was run to the green wire of the right rear tail light harness.

The green wire, on the right side of the vehicle, is for the turn signal. So this caused the right turn signal to act erratically.

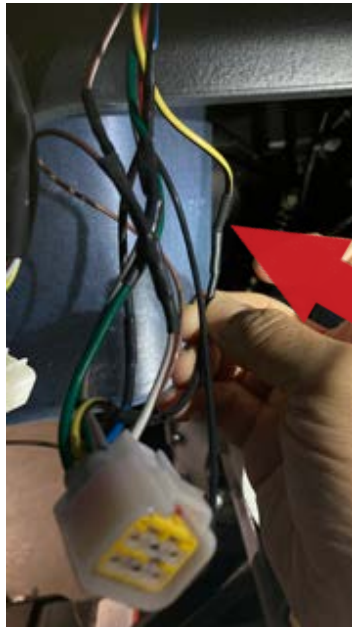
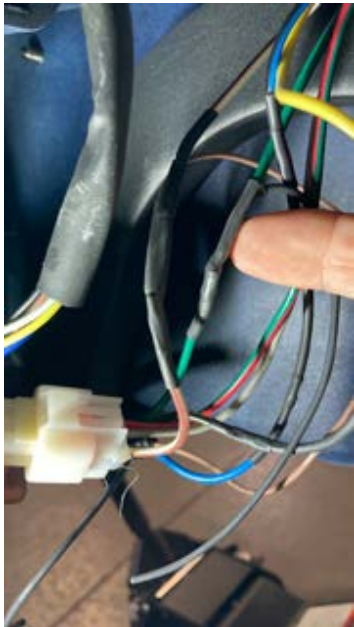
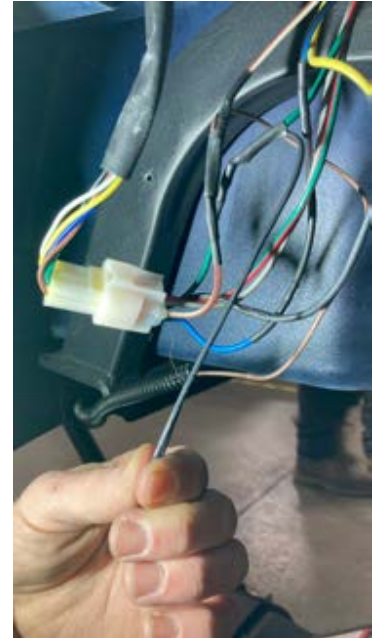

For proper operation, the black wire from the tag light, must be connected to the black/yellow wire of the vehicle harness.



Installing a Brush Guard

To be able to install your brush guard, you will need

- 4-M8x1.25x110mm bolts
- 4-M8x1.25x25mm bolts
- 12-M8 flat fender washers
- 4-M8 lock washers
- 4-M8x1.25 nylon lock nuts



To begin the installation, you will need to remove the front bumper cover. You will find four bolts holding the cover to the front bumper bracket. Remove these bolts from the back of the cover.



The bolts are located here, on the back side of the front bumper bracket. The brush guard will sandwich in between the bracket and the bumper cover. This is why the longer mounting hardware will be needed, because the distance will now be greater.

You will now have access to the front bumper bracket. You will need to drill 4-5/16" holes in these approximate locations. To find the exact location, you will need to hold the brush guard against this bracket, and center the brush guard to the vehicle, side-to-side. Once the brush guard is centered, you can mark onto the bumper bracket for drilling.



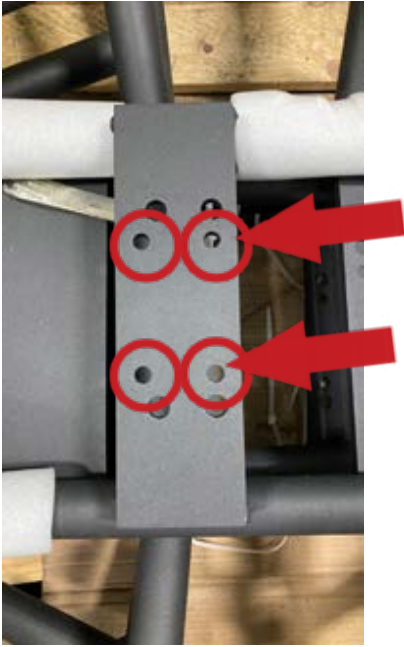

The holes that you will need to mark, are the holes closest to the center of the brush guard mounting bracket. In the photo, you will see the holes that are used.

You will now install the brush guard, using the short bolts, 8 of the M8 flat washers, and the 4-nylon lock nuts. These will go through the four holes you just drilled. Once this is complete, you will be able to install the 4-M8x1.25x110mm bolts, 4-M8 lock washers, and 4-M8 flat washers through the outer four holes. These will pass through the bumper bracket, the brush guard, and into the front bumper cover. This will secure the cover onto the front of the whole assembly and your installation is now complete.

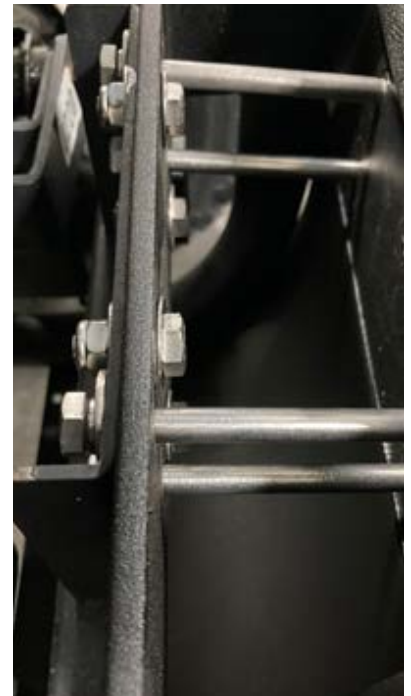

Headlight Replacement

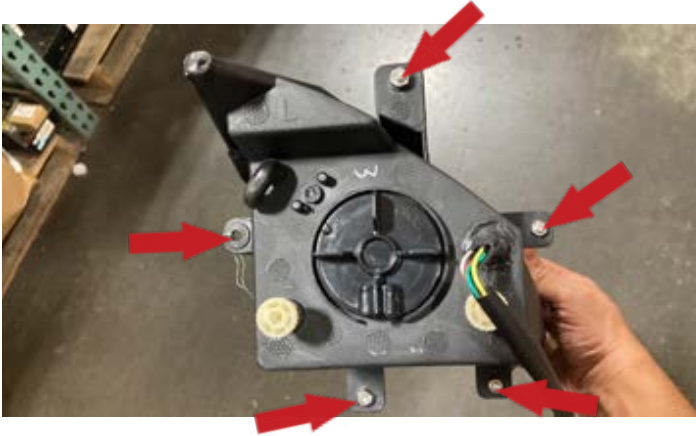

These are the mounting points for the Sirius headlight assembly. Two of the bolts are almost impossible to reach without removing the front body of the vehicle. There is an access hole behind each dash side storage compartment, but the bolts cannot be reached through these holes.



To begin removing the headlight, you will need to use a pin punch to drive out the center studs of the pop rivets securing the front body to the rocker panel, below the center of the dash cupholder, and along where the front body meets the floor around the roof supports. There should be 8 rivets in all.



Using a 15/64ths drill bit, you can drill the rivet heads at the rocker panels, at the sides of the floor at the roof support bases, and below the center dash cupholder.



Once all the rivets are removed, you will pull outward on the sides of the front body, where they meet the rocker panel until their tabs are free from the black trim.



Next, slide the rubber roof support boots upward, so that the front body can slide upward on the roof supports.

You are now ready to slide the front body upward, using the front roof supports. You can pull upward, to make sure that it is completely free and able to move upward.

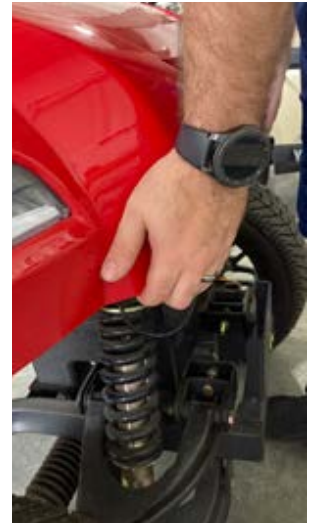

Using a support prop rod, you can support the front body once it has been pulled upward on the roof supports. You should be able to gain several inches between the front body and the rest of the cart components underneath it, using this method.

There is no easy way to reach the headlight retaining bolts, but we've found this is the easiest way to get to them. The bolts have nuts on the back side, and they are all 10mm.

Once you are done replacing the headlight, you should test the headlight for operation, then you will need to carefully lower the front body back into place. Shift the body as needed, to line up your rivet holes. Replace the rivets, beginning with the ones under the center dash cupholder, then the outer edges, then the rocker panels. The rivets are 3/16"x0.7" black rivets with .375" heads.



Hood Latch Cable Replacement



Inside the passenger side dash compartment, you will see the hood latch, beside a round black access cover. Pull the hood latch to open the trunk if possible. Use the power hood release button if the cable is broken. To begin the replacement process, you will need to pull this access cover out and toward you. This will let you see inside the space between the dash and the front body.



In this photo, we have the access cover removed, and you can see the cable leading to the latch handle.



In this photo, we have removed the right front roof support so we could show the retaining nut that holds the cable into its hole in the dash. This plastic nut is only finger tight, so you will simply start to turn it counterclockwise to remove it. The nut is captive on the cable, so it won't come off at this point.

Once the nut has been removed, the hood latch lever will be able to pull out of its hole in the dash. You will pull it out with some of the cable, enough to hold it with both hands.





You will now be able to pull the cable out of its slot. It is a very snug fit, into its groove. Pull the cable out completely. Once it is free, the lever will be able to swing out to expose the cable end ball.



Pull the end ball out of the hood latch lever. Once this has been taken apart, the captive cable retaining nut will be able to come off the cable. Set this nut aside for later.

Now you will be able to fish the cable out of its hole, out above the right front headlight, and out to the front of the vehicle. At this point, we will start to work inside the front trunk compartment.

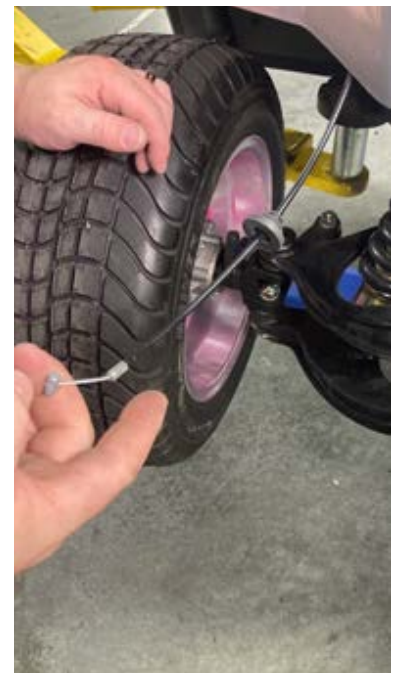

Watch: *How to open Sirius hood when cable breaks*



Take the cable end ball, and push it toward the cable end. This will force the cable into its sheath, and push the ball end up at the other end of the cable.

Here you will see how the ball end is extended up above its land. This will now let you manipulate it easier.



Feeling under the hood latch, you will find the cable, and see a white plastic retaining clip made on its end. The clip will be locked into a slot. To release the white clip, you will pull the cable laterally, toward the passenger side of the cart. Your cable will now be released, and can be removed from the vehicle.

To install the new cable, you will begin by fishing the new cable ball end under the front body of the vehicle and inserting the ball end into the front latch as shown. Then push on the white plastic retaining clip to lock it into its slot.





Feed the cable around the side of the front trunk compartment, and then over the right front headlight. It is a very snug fit, but you are looking to feed it toward and into the access hole where you removed the access cover.

Your cable will now be sticking out the access hole in the right side of the dash.



Install the black plastic retaining nut onto the new cable. This will need to be on the cable ahead of time, since it won't be able to go on after.



Install the cable ball and cable end into the hood latch lever in the reverse order that we took it apart. Test the assembly for proper function by closing the trunk and releasing it using the new cable. Then you will simply insert the latch lever assembly through its hole and hand tighten the black plastic nut on the back. Finish by installing the round black access cover.



Hood Replacement

To replace the hood, you will need a Phillips screwdriver, whether manual or powered. You will also need a 10mm wrench.



Start by pulling the hood release. This will let the hood open, for replacement.



With the hood open, you will find a Phillips screw that acts as the hinge pivot. There is also a round plastic peg that hooks into a detent notch, for holding the hood in the open position.



Using a Phillips screwdriver or power driver with a Phillips bit, remove the Phillips screw from each of the hood hinges. There is a flat washer located under the head of the screw. The nut on the opposite end of the screw is 10mm. You may need to use the 10mm wrench to hold the nut stationary.



Keep the screws, washers and nuts for reassembly.

With the 10mm wrench, hold the hood latch screw stationary while removing the Phillips screw with a Phillips screwdriver. Keep the hood latch hardware, for installation into the new hood. Lifting the hood latch away from the hood, together with the screws will allow you to move the whole subassembly over to the new hood. Install the nuts onto the screws and tighten.

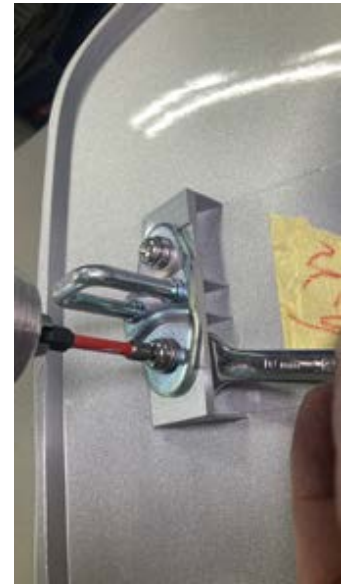

Install the new hood into the pivot detents, so that the hood will hold itself in the open position, hands-free. Install the hood hinge screws, with their flat washers under the screw heads. Install the retaining nuts on the opposite ends of the screws and tighten. Do not over tighten the screws, since they are intended to act as the hinge pins for the hood. Once these screws are tight, close the hood carefully to check the position of the latch parts to each other. The hood catch may need to be repositioned so that it meshes with the latch assembly properly. If the hood is slammed down without checking the alignment, damage to the hood or latch parts could occur.



Folding Windshield Replacement



For replacing the folding windshield, you will need a Phillips screwdriver and a 10mm wrench.



Loosen the windshield mounting screws on one side of the windshield. Once the screws are loosened on one side, you will remove the two nuts and set them aside with their washers.

Pull out and away on the side of the windshield where you removed the attaching nuts. The screws and rubber grommets will come away with the windshield. You will remove these screws and grommets and transfer them to the new windshield.



Now reaching across, support the windshield as it comes out from the two remaining grommets on the opposing end of the windshield.





Hook two windshield slots over the two remaining grommets in the front roof supports. Then install the grommets that came away with the windshield, into the two open slots in the new windshield.



Insert the two transferred screws into the open roof support holes. Make very sure that you don't pinch or damage the turn signal mirror wiring when installing the screws. Install the remaining hardware, and tighten the two nuts using the 10mm **wrench**.

Glass Windshield Installation



To install the glass windshield, you will need a Phillips screwdriver, 10mm wrench, and a drill with a 1/4" drill bit. It will also be helpful to have a silver Sharpie marker for marking the position of the holes, for drilling.

For mounting the glass windshield, you will need two strips of 1"x5/16" foam weatherstripping. This will be placed between the windshield and the roof supports, to prevent rattling when driving. These pieces will go between the mounting holes on each side.

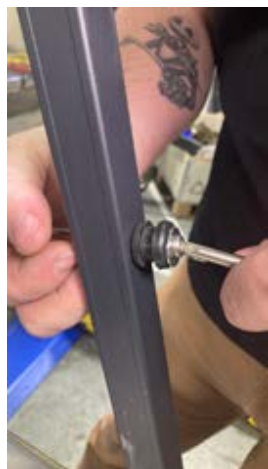

Refer to the section for Folding Windshield Replacement for removing the folding windshield. Then proceed to remove the remaining two folding windshield bolts, in preparation for installing the glass windshield.



While holding the glass windshield in place, against the front roof supports, use a silver Sharpie marker to mark the new hole placement of the glass windshield bolts. Make sure that the windshield is level before marking the holes for drilling.

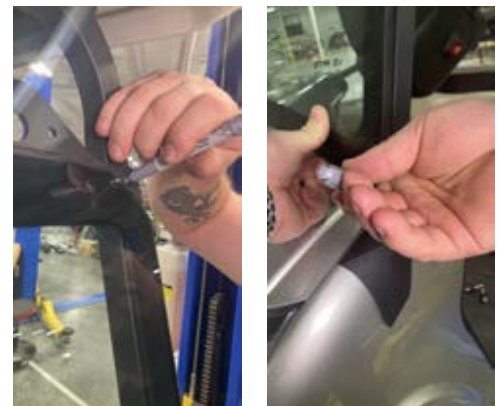



Start by drilling the two top holes. These holes are above the side mirrors, so there isn't a danger of piercing the turn signal wiring, coming from the mirrors. Drill the holes all the way through the front roof supports.

For the lower windshield holes, **you will drill through the front surface of the roof support only. Using a small screwdriver, you will locate the turn signal mirror wiring and move it to the side, before drilling the rest of the way through the roof support.** If the wiring is not

moved to the side, it may be pierced and cut by the drill bit going through the roof support.

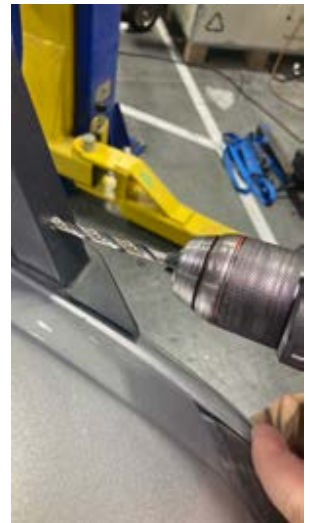

Complete the drilling, for all the holes, holding the mirror turn signal wiring out of the way of the drill bit in the bottom two holes.



Measure and cut two strips of weatherstripping that will extend between the two holes on each side, running down each of the front roof supports. Remove the protective backing, and affix the weatherstrip to the roof supports.

Using the 10mm wrench and Phillips screwdriver, install the glass windshield hardware and tighten.



2 Passenger Roof Replacement



To install the two passenger roof, you will need a ratchet, a 5mm Allen socket, a 13mm wrench along with a drill and 3/8" drill bit.

With the Allen socket, ratchet and wrench, loosen and remove all the bolts, and hardware from the tops of the roof supports. Capture all washers, nuts and screws for reassembly.



With all bolts removed, push upward on the roof, to dislodge the roof supports from the roof. You will now be able to remove the roof and set it aside.



When installing the new roof, you will need to use the drill and drill bit to open up all the mounting holes slightly, to allow the mounting bolts to fit through.

2+2P, 4+2P Roof Replacement



To replace the 2+2 or 4+2 roof, you will need an impact wrench, with a 5mm Allen socket and a 13mm wrench.



Remove all the bolts that attach the roof to the roof halo. For the 2+2, there are 10 bolts. For the 4+2, there are 14 bolts. Capture all the roof hardware and spacers, for later use. Pay special attention to the direction of the spacers, bolts and washers.

With the help of an assistant, carefully lift away the roof, from the roof halo. With the new roof, be careful not to damage the paint when reinstalling. Lift and position the roof, instead of sliding it across the halo.



Install all the roof spacers, washers, nuts and bolts before tightening any one bolt. Once all hardware is in place, then you can begin tightening.



2+2P, 4+2P Roof Halo Replacement

This replacement begins with the roof removed, in the previous section. The tools needed, are the same as in the roof replacement section. The handles along the sides of the roof halo should come attached to the new roof halo, so you will not need to remove them from the old unit, unless you would like to retain them for your stock inventory.



With the roof removed and set aside, you will remove the bolts that attach the roof halo to the rear roof supports. There are two bolts, one in each roof support.

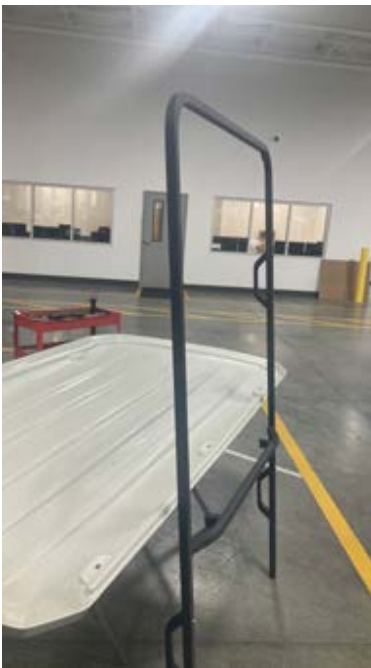

With the help of an assistant, you will lift the roof halo upward and slide its “legs” out of the rear roof supports. This will free the halo from the vehicle, for removal. Reverse these steps to complete the replacement. Then reinstall the roof, as in the previous section.

4P Front Roof Support Replacement



These tools will be needed, in order to replace the front roof support on the four passenger Sirius. These are an impact wrench, ratchet, 16mm socket, extension, Phillips screwdriver, pair of snips, 10mm wrench, 13mm socket, a few zip ties, and a 5mm Allen socket. You will also need an extendible support stick, to hold prop up the roof, as the roof support is removed.



Begin by using the Phillips screwdriver and 10mm wrench to remove two bolts that hold one side of the plastic windshield. You will be able to pull the windshield to the side with the bolts removed, to dislodge the opposing side from the grommets that are still in place.





Using the impact wrench and extension, with 16mm socket attached, you will locate and remove the bolts that connect the roof support into its sockets above the front wheels. These bolts are located above the front wheels and point straight upward. There will be one on each side of the vehicle.

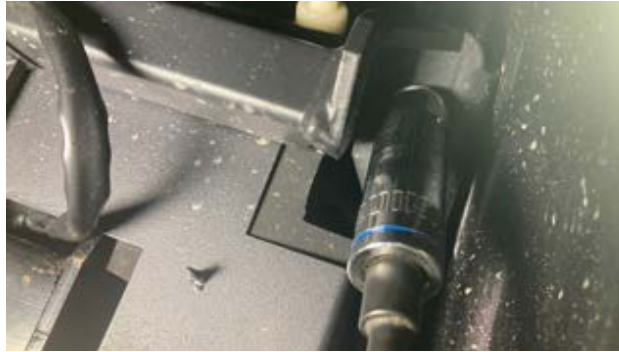

Place a shop rag on top of one end of the extendible support stick, to keep from scratching the roof. Insert the pole between the front seat cushion and the roof, and extend it upward. You can push the roof upward somewhat at this point, but not too far, since you will need to disconnect the turn signal mirror wiring first.



Reaching up above both front wheels, you will disconnect the two turn signal mirror connectors. The connectors are white 2-pin connectors. Snip any zip ties that are securing the wiring to the frame.



Using the ratchet, 13mm socket and impact wrench with extension and 5mm Allen socket, you will remove the two front roof bolts that secure the roof to the roof halo.

Returning to the extendible support pole, push upward on the roof, while extending the pole upward. You will be able to gain 6-8 inches of additional room now, with all the front bolts removed.



From the front of the vehicle, grasp both sides of the front roof support. It may be helpful to have an assistant for this step. If one isn't available, just take special care not to damage the paint on the front body of the vehicle with the ends of the front roof support as it's being removed. Reverse the removal steps, to complete the replacement.



Be sure to insert the "feet" of the roof support into the lower sockets under the front body. It is best to have an assistant to help guide the ends into the sockets without scratching the painted body.

Rear Roof Support Replacement



To replace the rear roof support, you will need a ratchet or impact wrench, 13mm wrench, 5mm Allen socket, 13mm deep socket, 16mm socket, and an extension.

To begin, use the 5mm Allen socket and 13mm wrench to remove the bolts that attach the roof halo to the rear roof supports. Capture and keep all hardware for reinstallation.



Using the same tools, remove the bolts that attach the front end of the roof halo to the front roof support.

With an assistant, lift off the roof and halo as an assembly and set aside.



Behind the front seat back, you will find the hand knobs for the seat back bolts. Remove these bolts with the help of an assistant. Remove the seat back and set aside.

Using a Phillips screwdriver, you will remove the trim screws that retain the seat belt buckle pocket. This is necessary to access the lower bolts of the rear roof supports.





Under the bottom flip seat cushion base, you will find two 13mm bolts that hold the cushion base to the flip seat frame. Remove these two bolts and capture all the hardware for reinstallation.



Using the 13mm socket and wrench, remove the four bolts that hold the upper flip seat frame to the rear roof supports. The seat frame will be snugly wedged between the roof supports. With an assistant, you will pull the seat and frame assembly toward the rear of the vehicle. This will separate the seat from the vehicle.

You will be able to lift the flip seat assembly upward and out of the vehicle, as a complete unit. Set the flip seat aside.



At this point, the rear roof supports are bare, without any adjoining parts. We only need to unbolt the bottom end of the support we are replacing.



Reaching through the open seatbelt pocket opening, you will find the two 16mm bolts that secure the bottom of the rear roof support.



Remove the two bolts from the support, holding the top of the support steady. You only need to slide the support up and out of the rear body of the cart. You will transfer the black rubber body grommet to the new roof support before installing it into the cart. Reverse the remaining steps to complete the installation.



Rear Body Replacement



To replace the rear body, you will need an impact wrench with 5mm Allen socket, 13mm wrench, 10mm wrench, 8mm wrench, 17mm wrench, 13mm socket, 17mm socket, 16mm socket, 8mm socket, ratchet, extension, and #1 and #3 Phillips bits.



Using the impact wrench with #1 Phillips bit, remove the trim screws that attach the seatbelt trim bezels in place. There are three screws in each bezel.



Remove the trim bezel from around the seatbelt, and feed the seatbelt through the body opening, so that they won't stop the body from coming off from around them.

Using a flat head screwdriver or trim panel tool, pry upward on the 12 black plastic trim clips that hold the golf bag well in the vehicle.

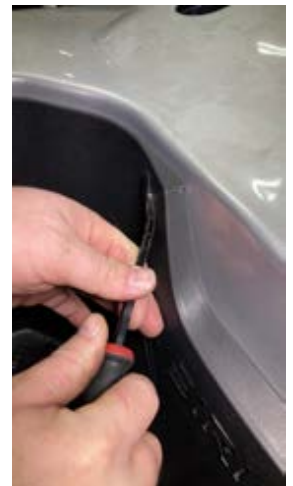

For reinstalling the golf bag well, you will need 12 black plastic trim clips. The original clips will break away when removing them.



Using the impact wrench and a Phillips driver bit, you will remove the three screws that go along the back edge of the bag well, to attach the rear bumper.



Moving into the wheel well area, you will remove the bolts that connect the rear bumper to the rear body. There will be one bolt at each end of the rear bumper.



You will now be able to remove the rear bumper.



Pull out and away, on the golf bag well and remove it from the vehicle.



Using the Phillips bit, remove the screws that connect the front body to the rocker panels. These screws come up from under the vehicle, and there will be one on each side of the cart.



Using the Phillips bit and a 10mm wrench, remove the remaining two screws that run along the length of the rocker panels.

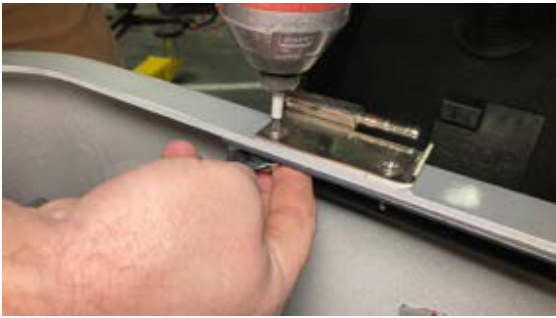

With the Phillips bit, and 10mm wrench, remove the two screws that secure each of the seat hinges. These screws also hold the rear body to the seat frame.



Using the same tools, remove the two screws and nuts on each side of the body. These screws were initially covered by the rocker panels. Removing this hardware will now free the sides of the rear body.



Using the same tools you will find two screws at the bottom of the battery compartment. These are along the front edge of the rear body, in the battery compartment, below the seat hinges.

Keeping with the same tools, you will remove the four screws that retain the charging receptacle. After removing these screws and hardware, you will pull the charging receptacle and its wiring out from the battery compartment.





Using an 8mm socket, remove the four screws in each rear inner fender liner. You will pull out and remove the fender liners and set aside.



With a small pair of snips, you will cut the zip ties that hold the tail light wiring to the rear frame.



Disconnect both of the tail light harnesses.



You will use an 8mm wrench to remove all the tail light hardware and transfer the lights to the new rear body. Once you've made the transfer, you are ready to install the new body onto the vehicle.

Replacing the Tail Light



To remove the tail light assembly, you will need an impact wrench with wheel nut socket, an 8mm bit driver or nut driver socket, and 8mm wrench.

After removing the wheel on the side you'll be working on, use the nut driver bit to remove the 4 self-tapping screws that attach the inner fender liner in the wheel well.



Pull downward and out on the inner fender liner. The entire section will come out of the vehicle, exposing the back side of the tail light assembly.



Once you have the light exposed, you will disconnect the wiring harness connector from the vehicle.



Once the wiring is disconnected, you will find there are two bolts and one nut that hold the light assembly into the vehicle. Use the 8mm wrench to remove this hardware. Capture and keep all nuts, bolts and washers for reinstallation. The light is now ready to ease out of the rear body. Be careful not to scratch any of the painted surfaces during replacement. Reverse these steps, to complete the process.



Motor

Description:

The Star Sirius vehicles boast a series of powerful and dependable motors, with an emphasis on quiet operation.

The 2 passenger models deliver 5.4hp (4Kw) AC motors, coupled with a 350 amp Curtis controller. This is the QDS motor with built-in thermistor.

For the 4 passenger model, we changed the game with the 6.7hp (5kw) QDS motor and married it to the 450 amp Curtis controller. This motor features the built-in thermistor as well.

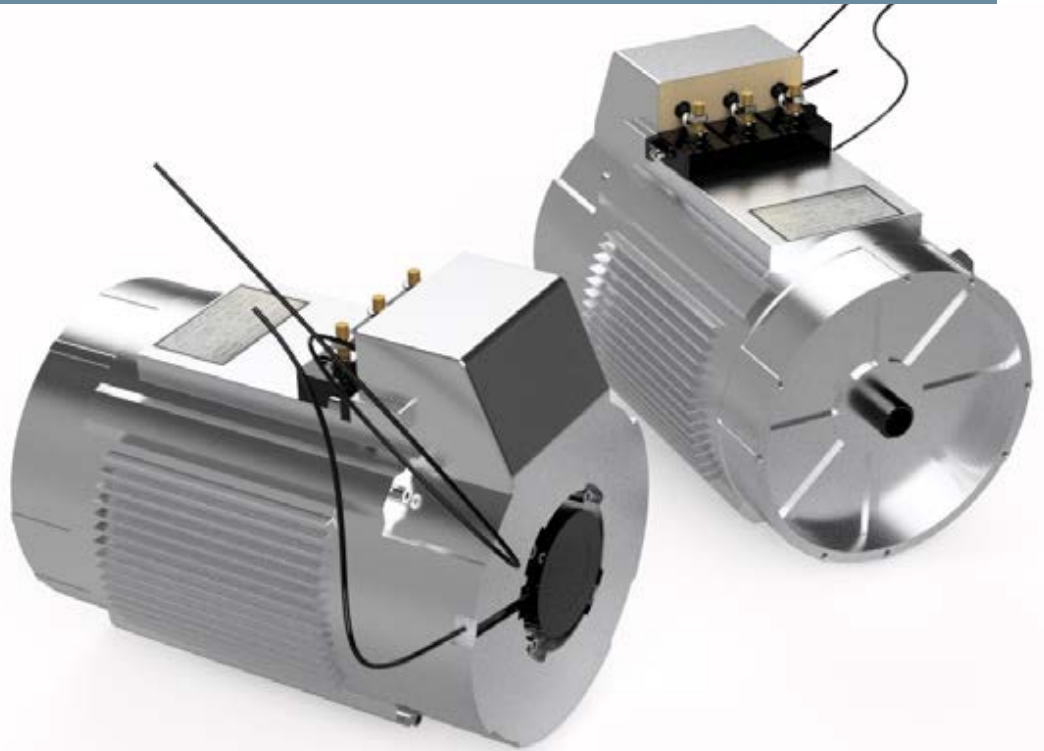

Table of Contents

[Testing your motor](#).....56

Testing your motor



For the AC motor, we will test for resistance between the motor phases. Each terminal has a letter designation and we'll test between each, while noting the resistance reading.



To begin, disconnect the motor leads. This will test the motor integrity by itself. Now test for resistance between terminal U and V. **All of these tests should result in a resistance of less than 1 ohm.**



Now repeat the same test between terminals U and W. Make sure that this is below 1 ohm of resistance.



Then repeat the same test between terminals V and W. Make sure that this is below 1 ohm of resistance. If any of these tests are above 1 ohm, then the motor is open. If any test has no resistance, then it is shorted internally.

As with any electrical circuit, tight and clean connections are a must. Be sure to check that all of the terminals have sufficient torque and that they're not corroded. Try to physically move the leads, to see if they're weakened or loose.



You can also check the resistance of the cables. For most cables the resistance will be in the range of .1 to .2 ohms. On this AC motor, we're measuring the resistance of the leads AND the motor. So expect a combined resistance of less than 1 ohm here also.

If resistance is too high, you will have an open condition. It is not typical that you will have a shorted condition, only because of the metallurgical composition of the wiring.



Sensors

Description:

The sensors on the Sirius vehicle, consist of the Encoder and the Thermistor. The controller has some sensors built into it, for measuring voltage, but these are the ones that are outside of the controller.



Table of Contents

Testing Encoders	81
Swapping Motor Phases	85
Testing the Thermistor	90
Testing Throttle Position Sensor	91
Replacing the 2P Throttle Sensor	92
Replacing the 4P Throttle Sensor	93
Replacing the Motor	95

Testing Encoders



There are several symptoms that may be related to bad encoders or encoder signals. Some of these issues can be accidentally caused by replacing a motor, and programming the controller for the new encoder.

If a motor has been replaced and the cart won't move, the encoder will need to be programmed. The encoder is phase encoded, so that the controller knows which direction you're going (forward or reverse). If the motor is put in without programming, the controller won't know if the motor is mounted right to left, or left to right. So it won't move until you tell the controller which way the motor is oriented.

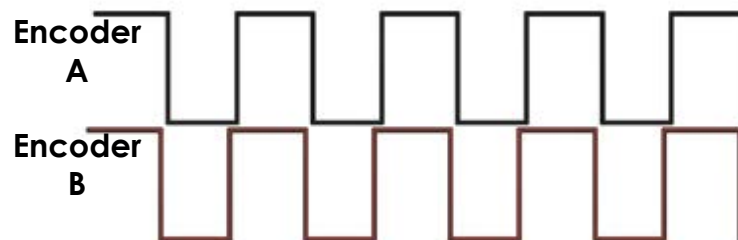

Once you know how an encoder normally works, you will understand how a controller reads the signals to control motor speed and direction. Later, we'll look at how an intermittent encoder signal can create a myriad of problems relating to motor operation/speed/or direction.

To keep it simple, the encoder sends two signals out to the controller. The signals are the same, except for the timing. One signal is just slightly delayed, by 90°. This first signal can be made forward, and the other reverse, or vice versa. But in a normal scenario, this is how the controller knows which direction the motor is moving.

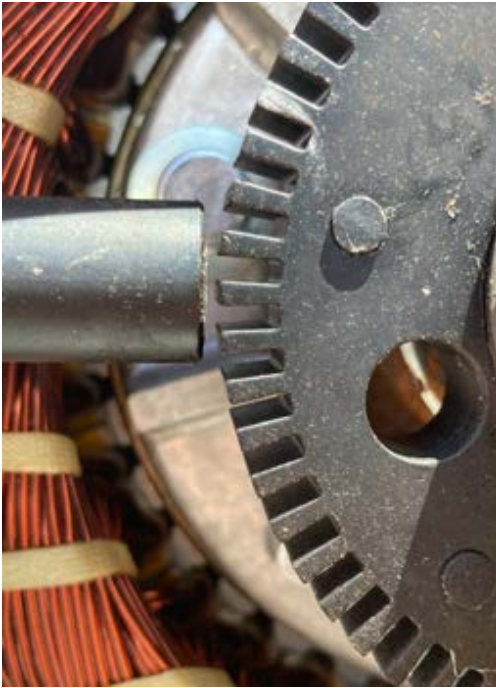

Each of the encoders consist of roughly the same components. There is the sensor, which picks up an induced signal each time a tooth passes by it on a toothed reluctor wheel. Some things that can go wrong are related to the air gap between the wheel and sensor, or movement between either component, but this is rare.

Some encoders are round, and cover the reluctor wheel, while some others are cylindrical and extend through the outer case of the motor. There is even a version that is mounted inside the motor, in one of the bearings. In this encoder bearing version, (the 36V AC motor) the bearing must be replaced inside the motor itself.



One key thing to keep in mind, about encoders, is that they very seldom cause a fault to set in the controller memory, even when the cart is completely disabled.

There are a few ways to check encoders. You can use a voltmeter, or oscilloscope, or the Curtis handheld programmer. We'll concentrate on the handheld programmer in this manual, since most Star dealers have access to these units and they have the ability to change the parameters if needed.



To begin, connect your Curtis handheld unit to the vehicle and turn the key to the on position. Go to Monitor and click Select at the bottom right of the screen.

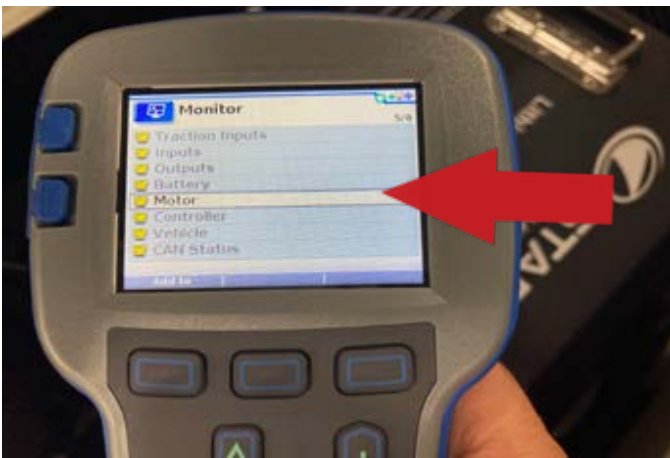

Next, scroll down to Motor and press the right arrow. This will take you to the motor menu.



Follow this by looking at Motor Speed A and Motor Speed B. They will show zero rpm when the cart is sitting stationary.

Now, while looking at this screen, push the cart forward and then backward. There should be an rpm reading on these two motor speed lines. This indicates that the controller is detecting an rpm signal from the encoder.

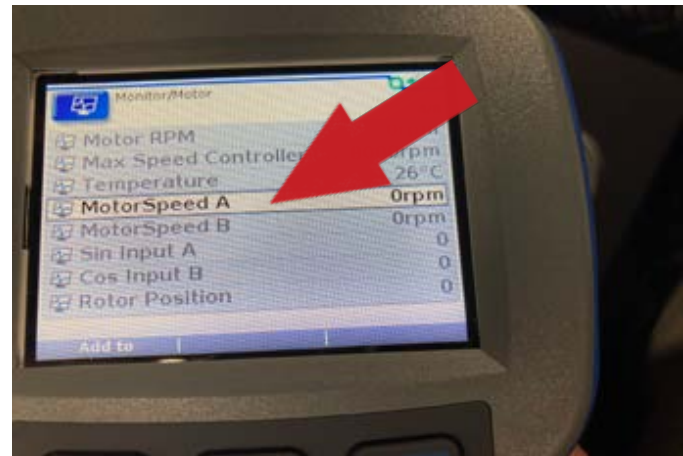

If there is no rpm signal during this test, check for continuity in the encoder wiring to the controller. If there is an open circuit in the wiring, the signal may be lost on its way to the controller. If the wiring tests good, then suspect the encoder.

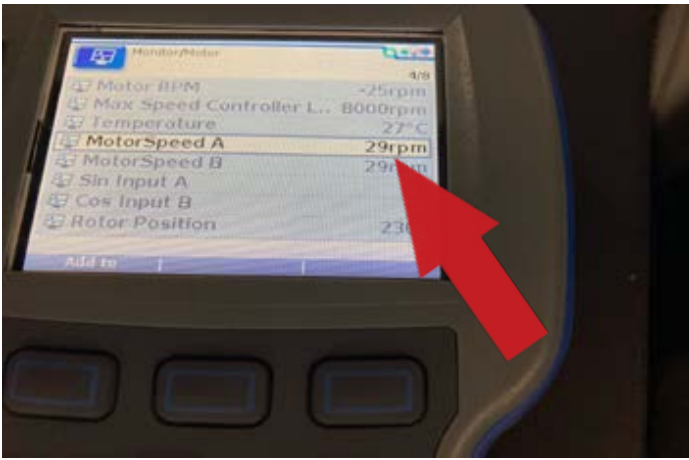

If there is an rpm signal on the Motor Speed A and Motor Speed B lines, then we can move on to the next step. This means that the signal is currently being reported to the controller.

Now scroll up to Motor RPM. You should see zero rpm when the cart is sitting stationary. Slowly push the cart forward. You should see a positive rpm number shown. Then push the cart backward. You should see an negative rpm shown.

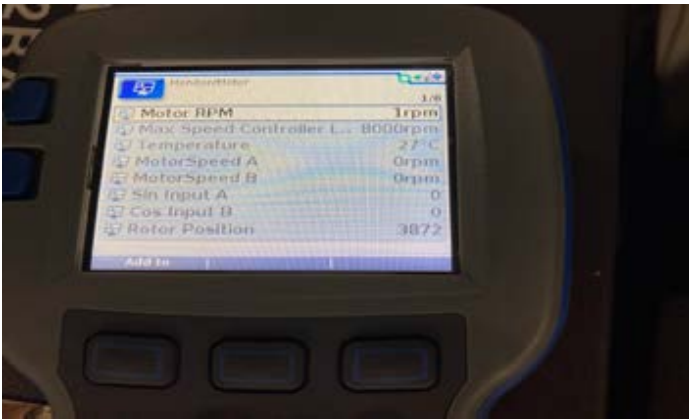

Forward=positive RPM

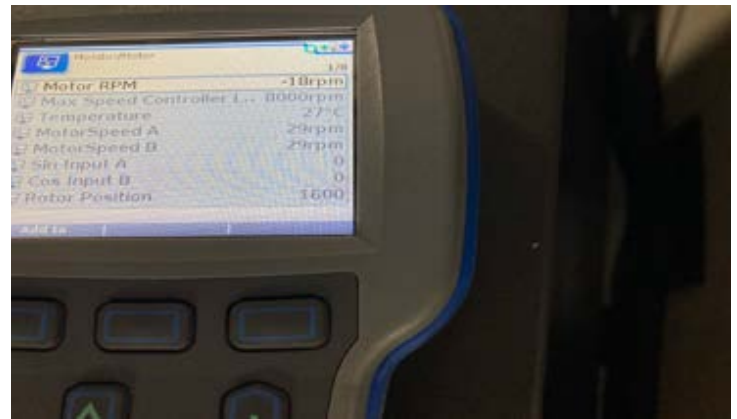

Backward=negative RPM

If this is **NOT** what you see, meaning you find these readings to be opposite to what's listed, you will need to proceed to the next step which will allow you to swap the motor phases.

The tests above will also need to be done after replacing a motor or encoder.

Because the encoder transmits speed information as well as directional information, you may encounter a situation where a cart will only move in one direction after the encoder has been replaced. Or you may find that the directions are reversed, going in reverse instead of forward and vice versa. To fix this issue, you will need to swap phases in the controller. Simply put, you will be telling the controller, when you see this encoder signal-go this direction.

To Swap Motor Phases

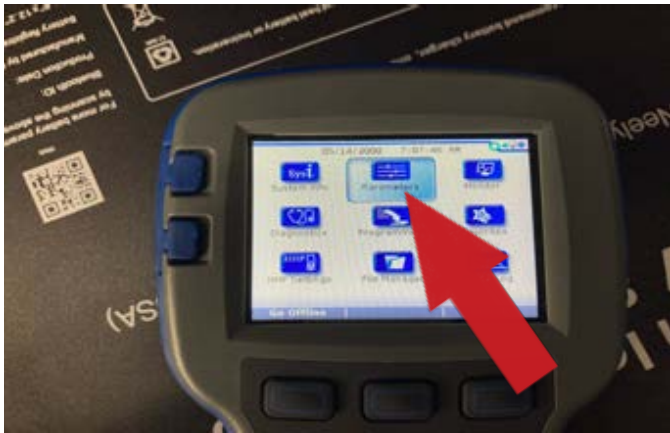

To swap motor phases, back out to the main menu screen and click on Parameters. Then scroll down to where you see Motor. Press the right arrow to enter the Motor menu.

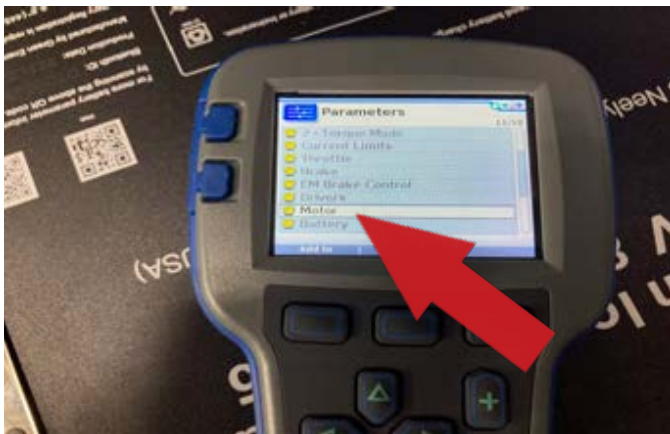

Once inside the motor menu, scroll down to Feedback Options. Press the right arrow, to enter the Feedback Options menu.

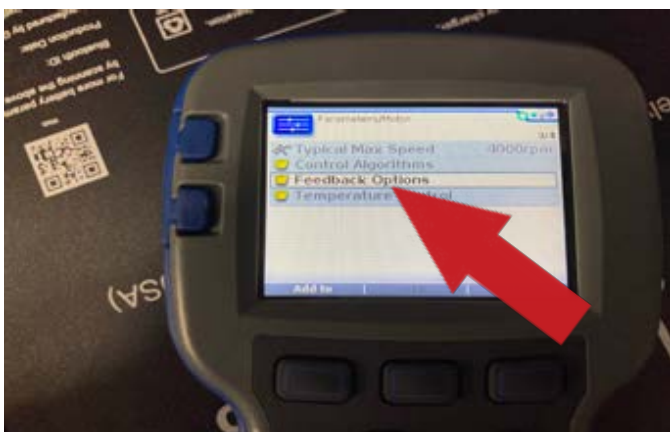

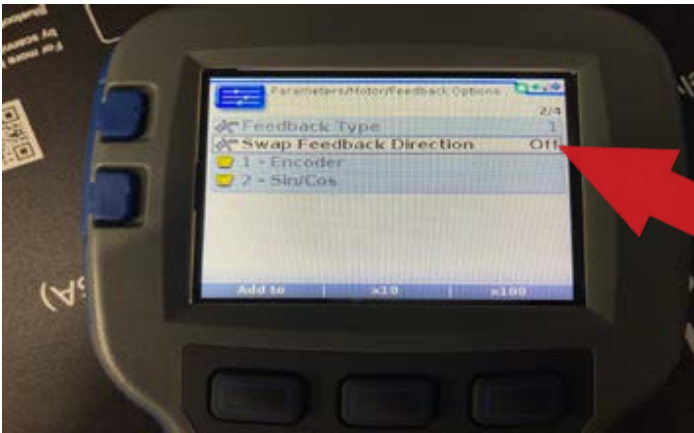

Now go to Swap Feedback Direction and change it from OFF to ON.

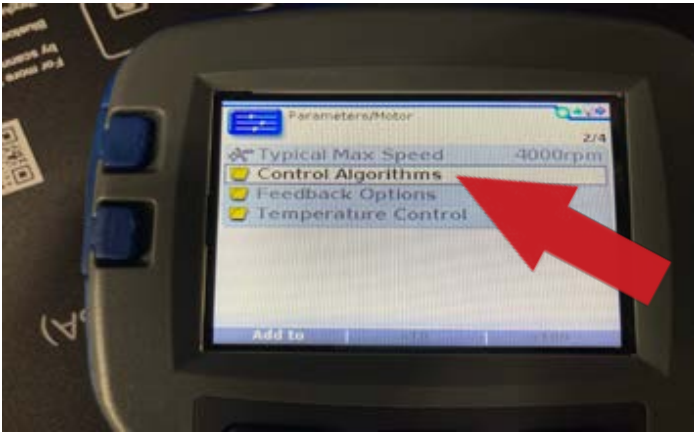

Next you will need to back out one step, and click on Control Algorithms. Click on the right arrow, and you'll enter the Control Algorithms menu.



Now you can press the right arrow on ACIM (Induction Motor). This is where we will be able to swap the motor phases.

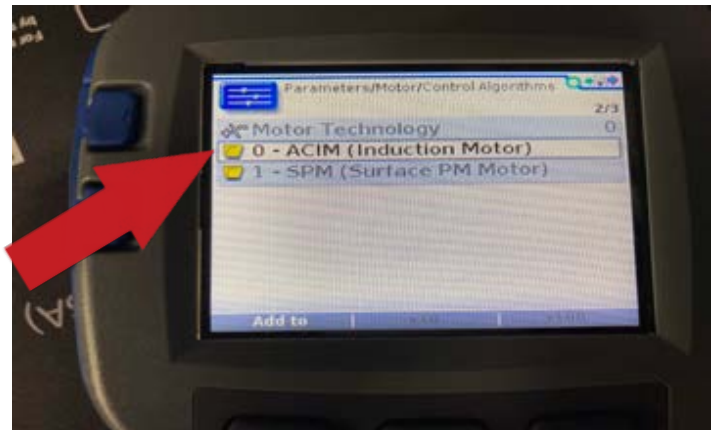

Scroll down to Swap Two Phases and turn this setting from OFF to ON.

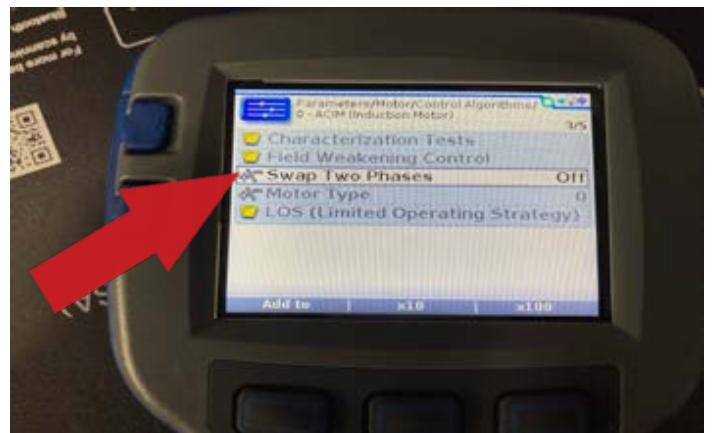

Signs of a bad encoder

As promised, we're going to look at some symptoms that can be caused by a bad, or failing encoder. **Remember, these issues are unlikely to register a fault in the controller.** Here are the signs, in no particular order:

- Cart only moves a few feet, and very slow
- Cart only moves a few feet and then stops
- Cart moves very slow and makes a low growling noise from the motor
- Cart only moves in one direction, but not the other
- Cart drives very slow, in any mode
- Vehicle drives by itself, until you turn the key off
- Cart drives in opposite direction than you intended to go

All of these performance issues can be signs of a bad encoder signal, or bad wiring causing the signal to be lost between the encoder and controller. Now you have the tools and know-how to accurately diagnose a faulty encoder.

For vehicles with 1243 or 1268 controllers

When testing the speed sensors (encoders) on vehicles with these controllers, you will connect the Curtis handheld programmer, as with the previously mentioned controllers. Once the programmer is connected, turn the key on to be directed to the main menu screen on the programmer. Go to Monitor>Speed Input. This will be the first menu option at the top of the screen. In normal operation, 0.8 will be shown when not moving.





Once the vehicle begins to move, the speed input value will increase. Unlike in the other controllers, this value will not be a negative value when moving in reverse. In this controller, this number will always be positive. The Forward Input and Reverse inputs are used for indicating direction. Using this speed input value, you can determine if the encoder is providing a signal to the controller.

For vehicles where your encoder signal is missing one channel

When testing speed sensors (encoders) you may find that one channel is missing on the handheld programmer when testing. If you have this condition, begin by checking to see that the encoder wiring is correct in its connector. For reference, your connector should look like this:

- 1) 5V+ (RED)
- 2) 5V- (BLACK)
- 3) 'A' Channel
- 4) 'B' Channel

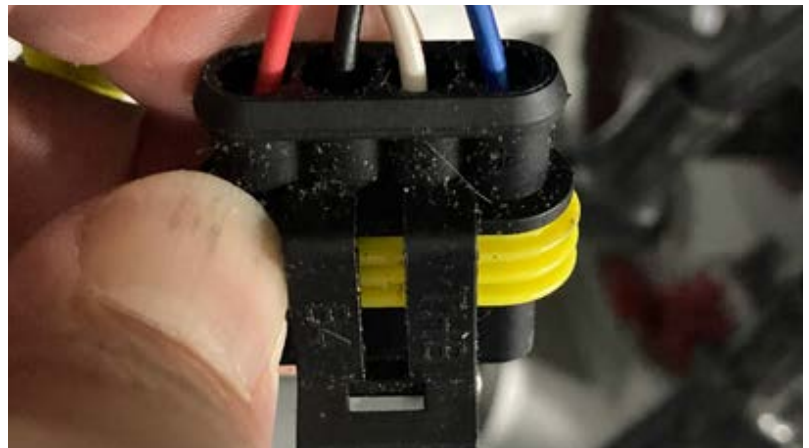

If your wires are not as shown, you will need to re-pin the connector. To begin, you will remove the red plastic pin lock, by prying out on the tabs along each end. If glue or sealant is present on the backside of the connector, carefully remove it so that the wires can slide out easily.



Once the pin lock has been removed, you will see locking tab slots above each terminal. Using a straight pick, or pinning tool/ paper clip, you will pry upward on the retaining tabs that lock each terminal in their slots. You will de-pin the blue and black wires and swap their positions according to the list:

- 1) 5V+ (RED)
- 2) 5V- (BLACK)
- 3) 'A' Channel
- 4) 'B' Channel



Be sure to replace the red rubber weather seal on each wire, if they come off during this operation. Each wire should be sealed against water intrusion, with these seals. Push each terminal into its slot until the locking tab clicks. A gentle pull, will verify the terminal is locked in properly. Reinstall the outer plastic pin lock, to complete the repinning process. Retest that your encoder is now sending both channel signals to the controller.

Testing the Thermistor

Both Sirius motors use a built-in thermistor, which is responsible for sending analog temperature data to the controller. This is a protection device for the motor components. At a temperature of 248°F (140°C) the controller will enter into motor cutback mode. Then at 320°F (160°C) the controller will stop motor operation.



On the Sirius motor, you will see a two pin connector like the one shown. With a voltmeter, set to measure resistance, you will be able to check the resistance through the thermistor and compare the reading to the table below. If you have a Motor Overtemp fault, or Motor Overtemp Cutback, you will want to check the thermistor resistance.

If you find that the resistance reading is wildly out of range, indicating that the temperature would be upward of 284°F, this means the thermistor/temperature sensor is faulty. This unit being tested, is at approximately 60°F.



Temperature	Approx. Resistance
70°F (21.1°C)	826 Ohms
80°F (26.67°C)	882 Ohms
284°F (140°C)	1262 Ohms
320°F (160°C)	1407 Ohms

Throttle Sensor Testing

When testing the throttle assembly on the Sirius vehicle, begin by connecting the Curtis handheld programmer and check for any current faults, with throttle pedal depressed. Then check throttle POT volts, under Monitor>Inputs>Throttle POT, while pressing the throttle pedal down. Voltage should vary from .2V to 4.9V. Then check Switch 1 (Throttle Interlock), also under Inputs, to make sure it changes from OFF to ON.



For testing Throttle Position Sensor/Throttle Interlock Switch	All Tests Measured on Harness Side	
<i>For any fault regarding throttle position sensor</i>		
Orange Wire to Black Wire	48V w/key on	This test checks available power and ground to throttle assembly. If power is not available, fix this issue first.
<i>If the throttle interlock switch does not change when throttle is pressed</i>		
White/Brown Wire to Black Wire	0V when released 48V when pressed	This test checks the interlock switch. If this reading is stuck at either voltage, and doesn't change with throttle pedal input, then this will cause the vehicle not to operate.
<i>If the throttle POT volts do not follow pedal motion, such as throttle POT high or low</i>		
Green Wire to Black Wire	0V when released 4.59V when pedal is fully pressed.	This test checks if the voltage signal moves smoothly with pedal travel. If this doesn't change, the controller will not know to turn the motor. If there are dropouts, there will be surging/stopping.

Replacing the 2P Throttle Sensor



To replace the throttle sensor, you will need a small pair of snips, some zip ties and a Phillips screwdriver.



Start by cutting all the zip ties that secure the throttle sensor wiring harness to the frame of the vehicle. Disconnect the black plastic throttle harness connector from the vehicle harness. This will free the sensor from the cart wiring.



Using a Phillips screwdriver, remove the two mounting screws and retain them for reinstallation. You will find that the throttle pedal has a 'D' shaped receptacle where the sensor shaft goes. The shaft will only go into the receptacle one way. Reverse the remaining steps to complete the replacement.



Replacing the 4P Throttle Sensor



The tools needed to replace the 4P throttle sensor are the same as for the 2P vehicle. Using the small pair of snips, you will cut the zip ties that secure the wiring harness to the frame rail under the cart.

Pull the frame tie point bands back from around the harness. These are the black metal straps that secure the wiring harnesses to the frame at regular intervals.

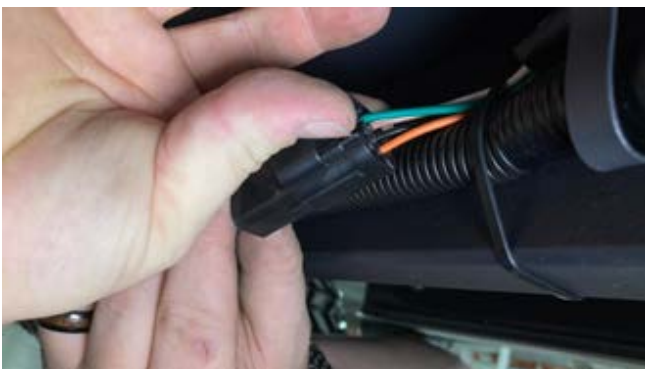

Disconnect the throttle sensor connector from the vehicle wiring harness. This will leave the throttle harness free from the cart now.

You will notice that the throttle sensor mounting screws are covered with a weatherproofing sealant. Using a pick tool, or your fingers, pull/pick this sealant from the screw heads to reveal the Phillips heads for a Phillips screwdriver to engage.



You are now ready to use a Phillips screwdriver to remove the two screws that mount the throttle sensor to the throttle pedal assembly.





In comparison, the 2P throttle sensor has a “D” shaped input shaft whereas the 4P sensor has a straight blade style input shaft. Be sure to align the shaft and sensor port to each other when installing. Reinstall the mounting screws, and reconnect the wiring, to complete installation. Reinstall the sealant, using black RTV sealant to cover the screw heads.

Replacing the Motor

To replace the motor, you will need a ratchet with a 13mm socket, a 14mm socket, small pair of snips, 14mm wrench, 16mm wrench and either a 4mm or 5mm Allen socket depending on the year of the vehicle. You will also need a jack with jack stands, or a dead man to support the rear end while working on the motor. For the input shaft, you will also need a small dab of high temperature multi-purpose grease.

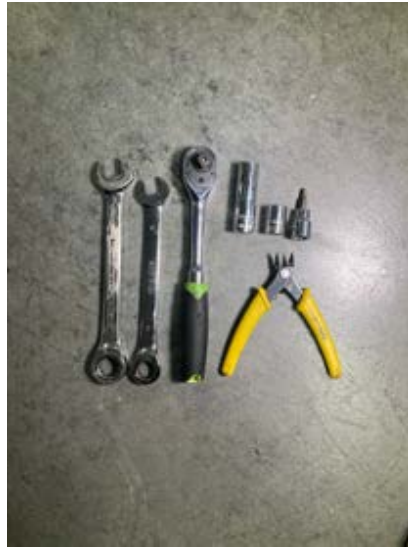

On a lithium equipped vehicle, turn off the power button on the battery if applicable. Then disconnect the battery cables, using a ratchet and 13mm socket. If the vehicle is lead acid equipped, use a 14mm socket to remove the battery cables.



Place the dead man support under the center of the rear end assembly. If you are using an overhead vehicle lift, be sure to place a safety strap over the vehicle floor, so that the vehicle doesn't fall off the lift when you put pressure under the rear end. You will use the dead man to apply pressure, in order to remove the lower shock mounting bolts.



Watch: *SERVICE BAY-How to put a vehicle on the lift safely*



Using a 14mm and 16mm wrench, loosen and remove the lower mounting bolt from each of the rear shocks. You may need to rock the rear and upward, to release each bolt from its mount. Set these bolts aside for later.

Once the lower shock mount bolts are removed, you will be able to slowly lower the dead man. This will let the rear end swing downward on the rear swing arms. **DO NOT** let it swing down uncontrolled! You will only let the rear end swing down a couple inches. Using the small snips, you will cut any zip ties that are securing the encoder and thermistor wiring to the frame member. Now you will reach above the motor and disconnect the encoder and thermistor wiring connectors.





With the connectors unplugged, you will be able to release a little more pressure on the dead man. Lower the rear end while watching the three motor cables. They will be secured to the frame member with zip ties. Cut the zip ties with the snips.

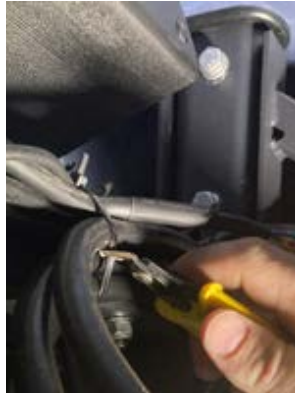

Once your zip ties are removed, you will be able to lower the rear end down low enough to remove the nuts from the motor cables. Slide the rubber motor connector covers back, to expose the motor terminal nuts. These nuts will either be 13mm or 14mm, depending on the year of the vehicle. Each nut will have a lock washer, and a flat washer under it. Keep these washers for reinstallation later.



With your 13mm socket on a ratchet, remove the motor lead nuts. Once these are disconnected, you will be able to lower the rear end down without restriction. Only lower the rear end enough to get the motor out, after its bolts are removed.

There are 5 Allen head bolts that hold the motor to the rear end. Depending on the year of the vehicle, these may be 4mm or 5mm Allen bolts. Using the proper Allen socket, remove these 5 bolts. The motor can now be separated from the rear end. Be aware that the motor is heavy, especially when held overhead.





Reverse these steps to reinstall the new motor. Place a small dab of the high temperature grease to the input shaft splines of the new motor.

Be aware that the motor lead connections are labeled where they connect to the motor. They are labeled 'W', 'V' and 'U'. The motor cables are also labeled with these corresponding letters. Be sure you connect the right cable to its correct mating terminal. If the motor does not operate, double check that these leads are connected in the right order.

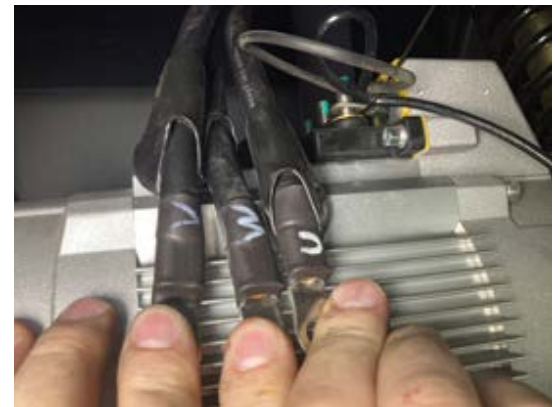

Charger

The Star Sirius vehicle comes with a Lester Summit II charger. With the lead acid model, you will find the 650W charger located under the front of the vehicle. The lithium equipped vehicles will have the 1050W charger located on the driver's side of the battery compartment.

These chargers need to have an AC supply voltage, via the charger receptacle. The charger has an AC present LED indicator, that shows if AC is present to the AC side. The lithium vehicle charger also uses a DB9 cord that needs to have communication to the battery. In either battery configuration, a DC supply voltage of at least 13-15 volts must be supplied to the DC side, for the charger to operate.

If the charger will not turn on, these connections will need to be checked first. The Lester Charger

Connect app can be invaluable for diagnosing charging issues on Star Sirius vehicles.

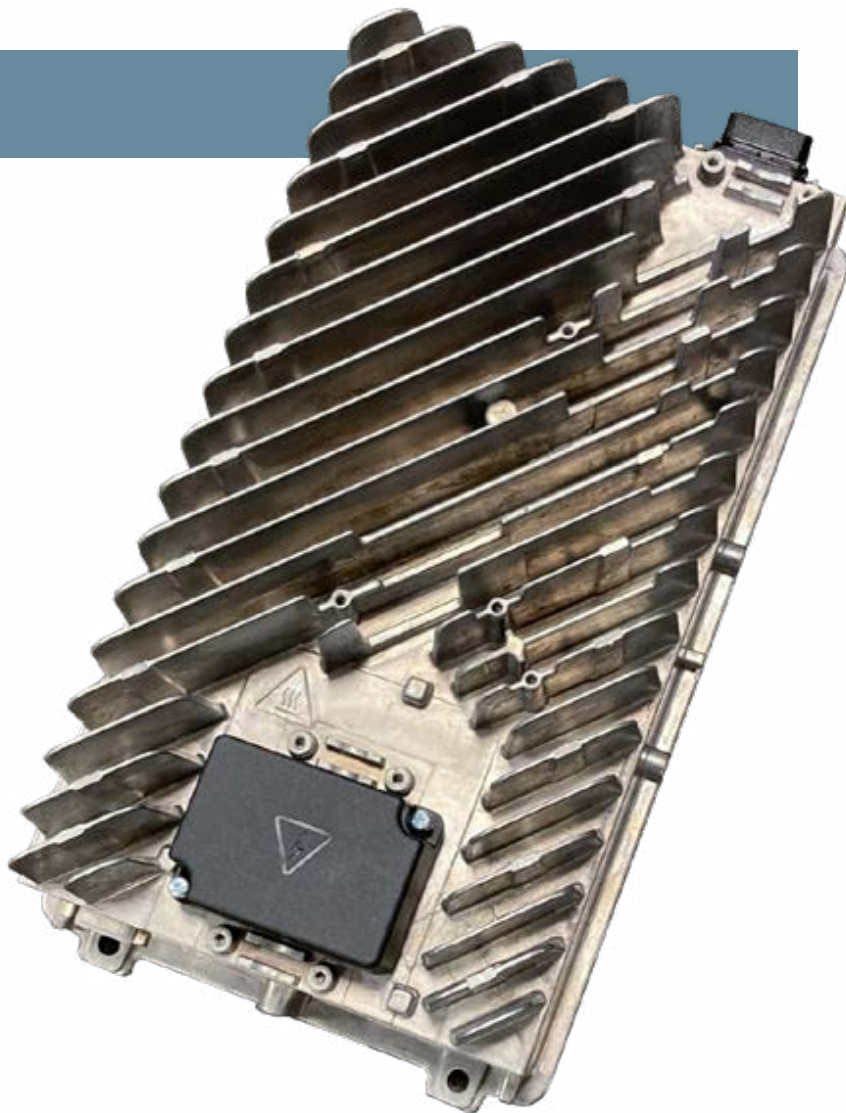
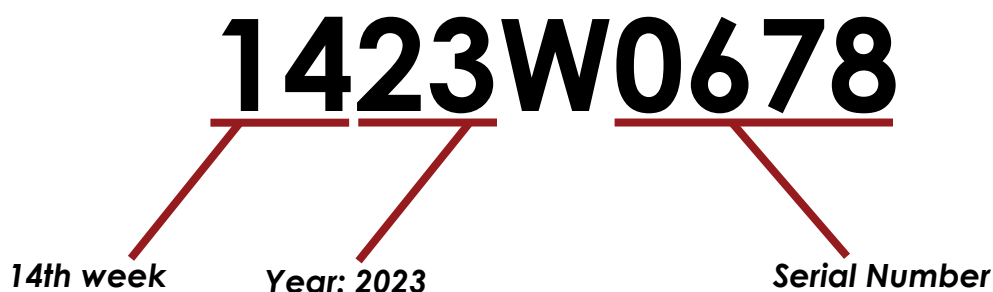

Table of Contents

Lester Charger Identification	100
Resetting your charger	101
Changing charger profiles	102
Dual Voltage Systems	106
Accessing Charger Histories	107
Replacing the SLA Charger	113
Replacing the Lithium Charger	117

Lester Charger Identification

The Lester charger has an identification number located under the barcode on the white ID label. This number consists of four digits, a 'W', followed by another four digits. The first two digits before the 'W' are the week designation. The second two digits before the 'W' are the year designation. The last four digits, after the 'W' are the actual serial number of the charger.



In this image, you can see that the week is the 14th, and the year is 2023, with the serial number of 1948. You can use this new information to know the production date of your Lester charger.

Resetting your charger



You may run into an issue where your charger will not operate, on a lead-acid battery equipped vehicle. The charger may only light the blue AC present LED. Or, the charger may have a blinking amber light but no actual charging is taking place.



These issues may be fixed by performing a simple charger reset. This should only take a few minutes to do, and you will be able to charge normally again quickly. When this reset is needed, it is usually caused by excessive arcing, when installing the battery or charger cables.



One of the best tests for whether a reset is needed, is if the Lester Charger Connect app keeps kicking you out, not letting you connect.

To reset the charger, first disconnect the charger cord from the charger receptacle. Then choose any of the smaller battery cables and disconnect one end. Leave this cable unhooked for approximately five minutes. When reconnecting the cable, **BE SURE TO KEEP ARCING TO A MINIMUM.**



If there is more than one arc, when reconnecting, restart the procedure again. If the cable is connected with little to no arcing, tighten the cable fully and reconnect charger to electrical outlet and verify charger operation and that the app now connects properly.

Changing Charger Profiles



This guide will show you how to check and/or change your charger's profile. If your charger profile is incorrect for your battery setup, you can "cook" your batteries or not charge them fully. This can lead to battery damage, failure or reduced run-time.



Start by turning the key off, with the vehicle in neutral. Connect the charger cord to your charging port and verify the LED on the cord is on, as well as the LED on the charging port. Next, check that the three LED's are lit on the end of the charger itself. These lights should indicate at least a boot-up sequence, indicating there is boot-up power available.



You will need to look on the charger's information sticker for the charger ID number. As shown, it is located right below the barcode. It may be helpful to use a smartphone camera to take a picture of the sticker, since it is usually difficult to see it at the angle that the chargers are mounted into the vehicles.



On your smartphone, you can download the Lester Charger Connect app. This app will allow you to communicate with the Lester charger in Star vehicles. Once you have downloaded and started the app, you will see this screen. The app will continue to install and open.



Once the app is open, it will automatically begin to search for nearby chargers that can be connected to. This is why the charger cord needs to be connected and the charger operating.

The list will populate with the accessible chargers within range of your phone. Click on the charger that matches the number you recorded from the charger's information sticker.

This will start the connection process, with your specific charger.

When you've clicked on the correct charger, you will see this screen. It will automatically read the system information from the charger.

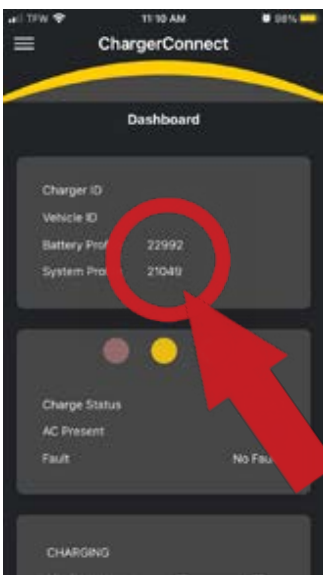
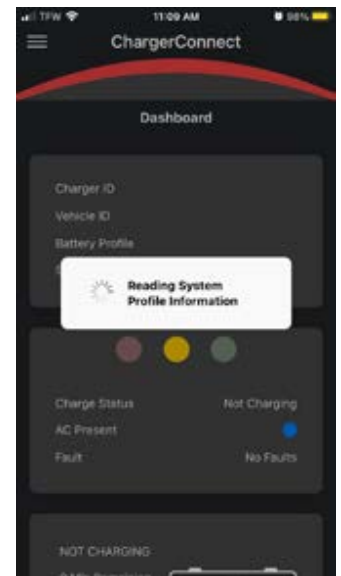
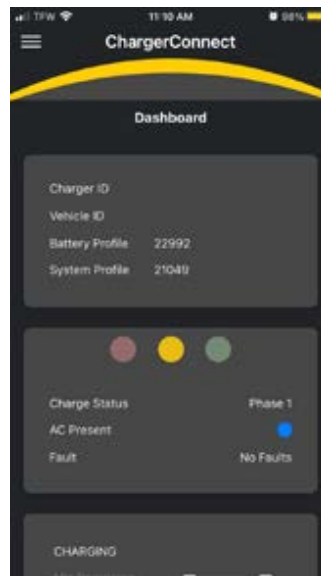

The first screen you will see is called the Dashboard. This is the main screen for viewing useful information. There are two important numbers that you will notice on this screen. These are the Battery Profile, and the System Profile.

In this guide, we will deal with changing the battery profile, since it is the most common item you will run into, in the field.



When you click on the menu button, at the top left corner of the screen, you will see some options are “grayed out” until you click the Stop Charging button on the main Dashboard screen.

Once you hit Stop Charging, all the options will become available in the menu screen.

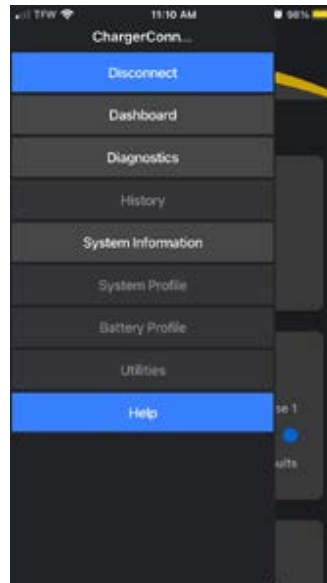

You will now be able to use the menu button to select Battery Profile. This will take you to the area where you can choose the proper profile for your battery system.

Once you're inside the Battery Profiles menu, you will see the installed profile(s) at the top, with a green check mark beside it. You will also see some empty slots where other profiles can be installed.

If the profile for your battery configuration is not shown in the list, you will need to go to the bottom of your screen and click on Cloud Profiles.

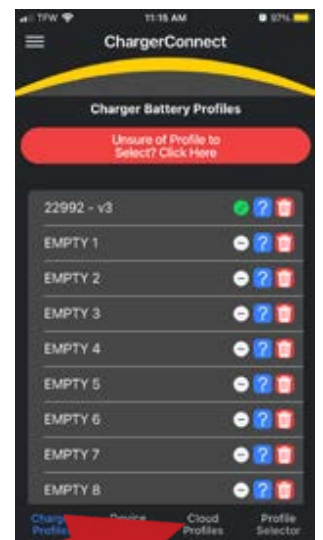

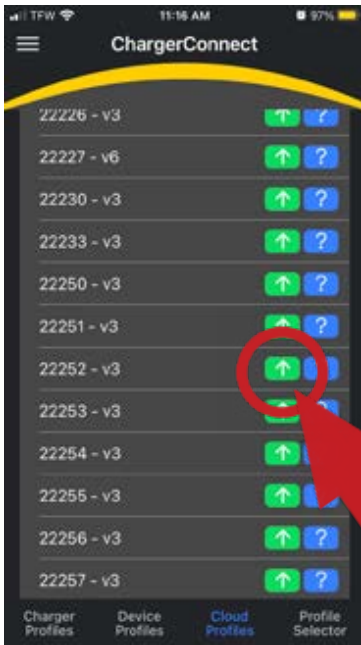

By clicking on Cloud Profiles, you will be able to select from profiles that are available online. You will want to click on the green arrow beside the profile you need for your particular battery.

Here, we are selecting the **22252** profile for download.

At this point, the app let you know that the profile has been successfully stored locally. Click on the button that says Device Profiles. If you see a notification pop up, asking if you're connected to an EZGO, click Yes. The app will then ask you which slot you want to install the profile into. Choose any empty slot such as #19 and the profile will be installed into that slot. A notification will pop up stating that the charger needs to be rebooted, in order for the changes to take effect.

Once the charger has been rebooted, your charger is now ready with the proper profile. You must now remember to go to the main Dashboard screen, and click the Start Charging button at the bottom of the screen.

You are now able to unplug your charger cord, or charge your battery to full capacity as normal.

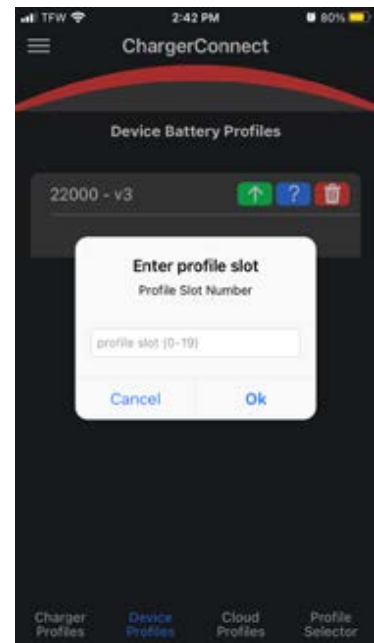

Here are some of the most common battery profiles you will need for Star vehicles.

22252 for T-105 48V (8 battery setup)	22252 for T-875 48V (6 battery setup)	Must Set to Scalable Auto Profile
22992 for all Lithium		
22252 for 36V battery setup		Must Set to Scalable Auto Profile

Dual Voltage Systems

The 22252 profile is able to charge dual voltages, either 36V or 48V. For this reason, you must also enable the auto detect feature in the charger, when using this profile.

You must finish all the previous steps, for changing the charger profile, before enabling this feature.

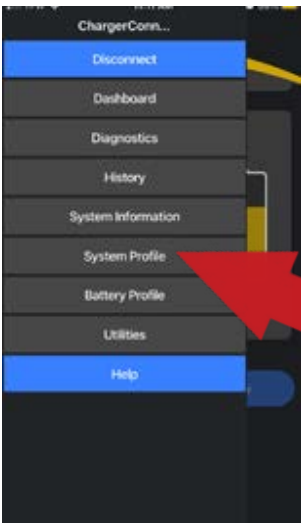

To continue, click the menu button from the Dashboard screen. Click System Profile. This will bring you to the Charger System Profiles page.

You will see a button at the bottom that says 36V or 48V Auto Profile. Click this button, and select Scalable Profile. Then hit OK.

This will set the charger to automatically detect the system voltage and profile from the device profiles list.

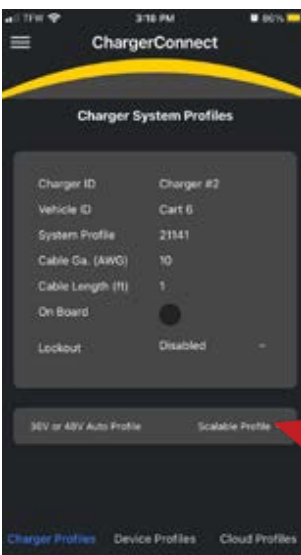

VERY IMPORTANT NOTE: When in Auto Detect mode, the 36V charger will start in 48V mode for 10 minutes, until it detects that the pack is a 36V pack. Then it will drop into 36V charging mode.

Accessing Charger Histories



Now we're going to look at how to check your charger's history records. This information can be handy for diagnosing discharged batteries, or battery issue in general. These records can confirm the charging times and conditions that can help educate customers for better charging of their batteries.



Start by turning the key off, with the vehicle in neutral. Connect the charger cord to your charging port and verify the LED on the cord is on, as well as the LED on the charging port. Next, check that the three LED's are lit on the end of the charger itself. These lights should indicate at least a boot-up sequence, indicating there is boot-up power available.

After the boot-up sequence, the blue AC present light should remain on, along with one colored LED, showing which charging phase is currently in process.



You will need to look on the charger's information sticker for the charger ID number. As shown, it is located right below the barcode. It may be helpful to use a smartphone camera to take a picture of the sticker, since it is usually difficult to see it at the angle that the charges are mounted in the vehicles.



On your smartphone, you can download the Lester Charger Connect app. This app will allow you to communicate with the Lester charger in Star vehicles. Once you have downloaded and started the app, you will see this screen. The app will continue to install and open.



Once the app is open, it will automatically begin to search for nearby chargers that can be connected to. You will need to plug in the charger cord and connect it to the wall outlet, so that the charger is able to operate.

The list will populate with the accessible chargers within range of your phone. Click on the charger that matches the number you recorded from the charger's information sticker.

This will start the connection process, with your specific charger.

When you've clicked on the correct charger, you will see this screen. It will automatically read the system information from the charger.

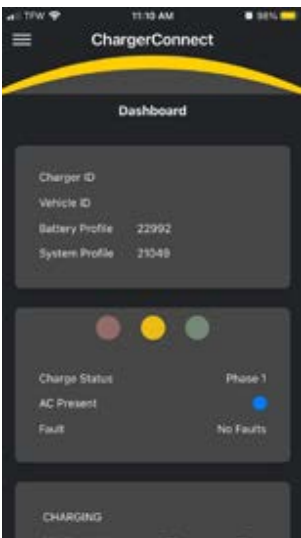
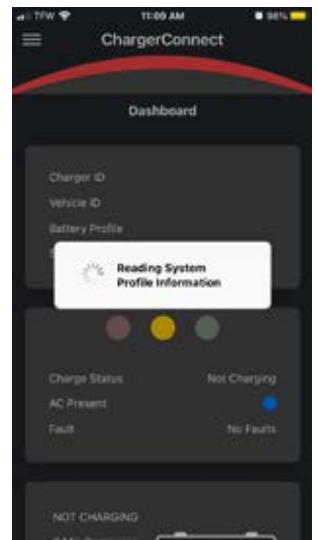

When the app has connected to the charger, you will be brought to the Dashboard. This is the main screen for viewing useful information.

When you click on the menu button, at the top left corner of the screen, you will see some options are “grayed out” until you click the Stop Charging button on the main Dashboard screen.

Once you hit the Stop Charging button, all the options will become available in the menu screen.

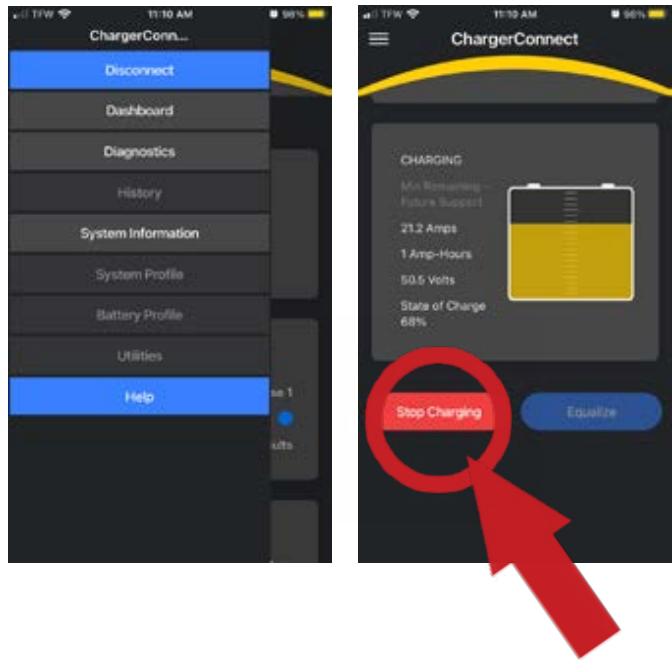

You will now be able to use the menu button to select History. This will take you to the area where you can view the charging records for your battery system.

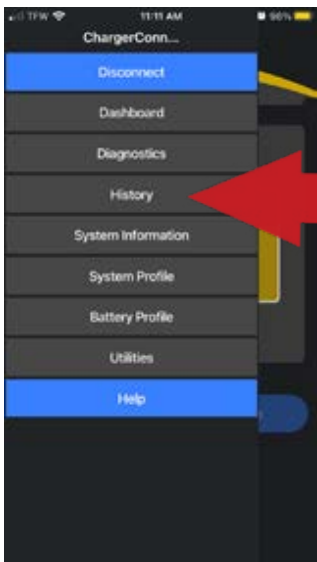

Once you're inside the Charger History screen, you will be able to see the number of charge cycles. At the bottom of the screen, you will see more information such as the amount of time each cycle lasted and the amount of amps per hour charged.

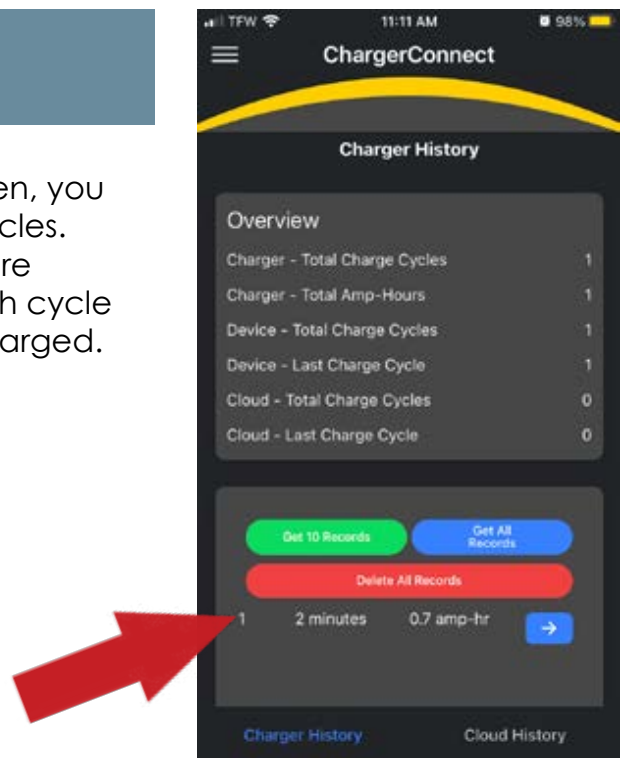

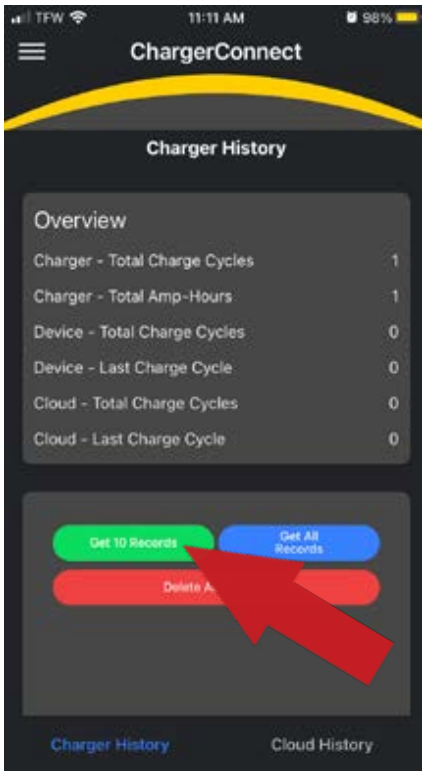

By clicking on the Get 10 Records button, you can access 10 more charger cycles that were stored. With this information, you can find issues such as power outages at customers' homes, or multiple insufficient charge cycles.



It is important to check these charger records whenever there are repeated instances of batteries being overly discharged, or when there is a question whether an issue is battery related as opposed to charger related.

To get all charger records, you can click the blue Get All Records button. This will allow you to see all the records the charger has. When using the green Get 10 Records button or the Get All Records button, the records are now stored in your phone. Now we can upload the records to the Cloud, so that they can be accessed by Star technical support or Lester technical support.

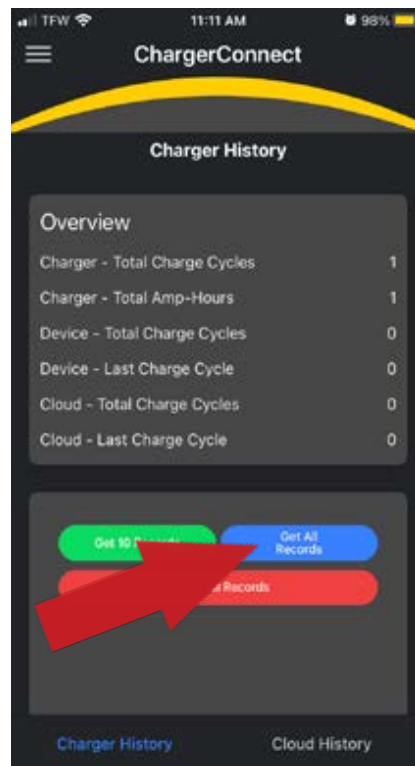

Uploading your charger histories to the cloud.

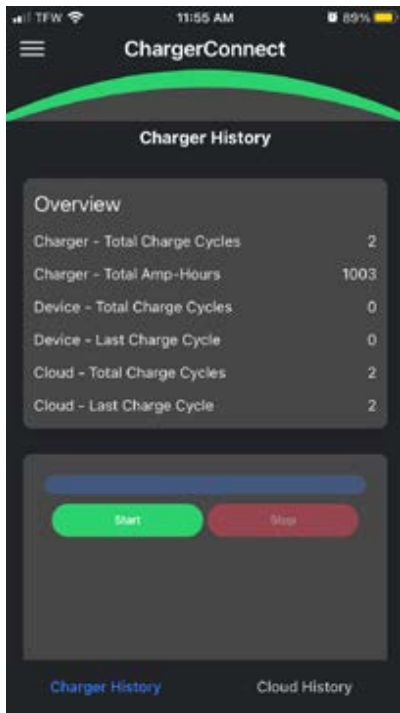

Once you've clicked either of the buttons to get records, you will be brought to this screen. Click on the Start button, to begin the download process. You will see the progress bar moving across the screen, showing how much time is left for the full download.

When the download is complete, you will see this screen. The charger histories will be shown at the bottom of the screen and you can scroll down to see more. But to upload the histories to the Cloud, you just need to click the Cloud History button at the bottom right.

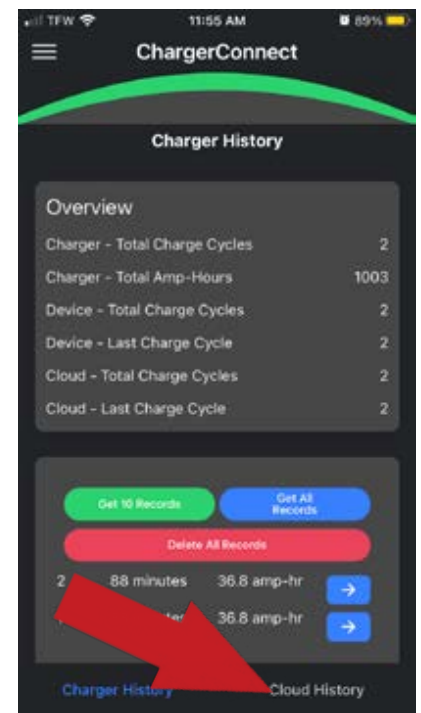

At this screen, you'll simply click the Start button. This will start uploading all the records you've captured, to the Cloud.

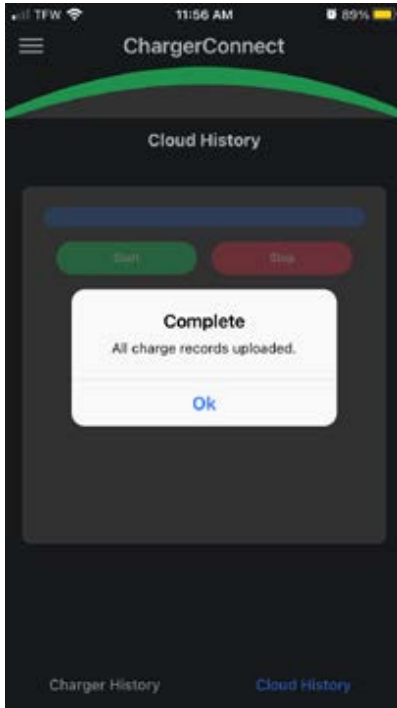
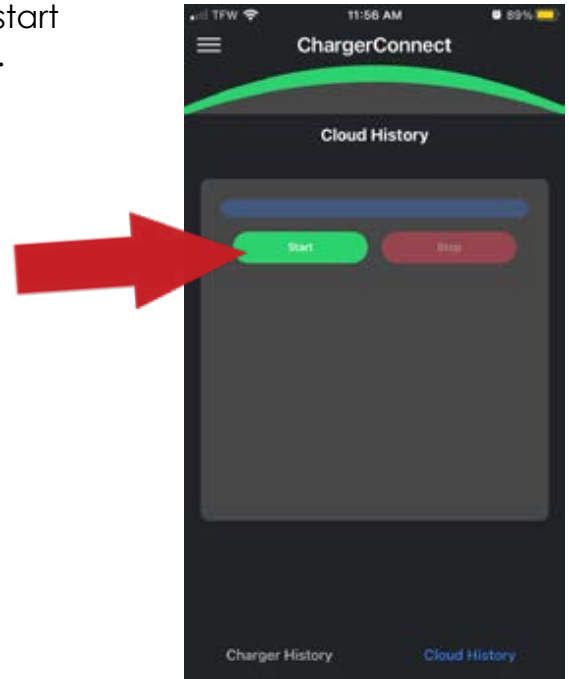

You will see a notification pop up, indicating that the upload took place successfully.

We, Star tech support, will now be able to access the records remotely. **Be sure to have your charger ID number ready, when you call or email tech support. We won't be notified that records have been uploaded, unless you contact us.**

Replacing the Charger-SLA



To replace the SLA charger, you will need some zip ties, a small pair of snips, a 14mm socket or wrench, a ratchet with a 10mm deep socket, a short extension (preferably wobble), a Phillips screwdriver, and a stubby Phillips screwdriver.



Begin by disconnecting the battery cables from the batteries. Set the cable ends aside, so they don't accidentally make contact with the battery terminals while you are working.



Raise the vehicle so that the front end of the vehicle is high enough to access the front firewall area. You will need to be able to turn the front wheels side to side fully, to reach the cables and bolts of the charger.

Using the small pair of snips, cut all the zip ties that secure the wiring harnesses leading to the charger. You will need to disconnect this wiring from both ends of the charger in the following steps.



Using a Phillips screwdriver, you will loosen the small black screw that retains the black AC cord into the charger on the driver's side of the vehicle. It helps to turn the steering wheel and wheels all the way to the right for this step. Unplug the AC cord from the charger and let the end hang out of the way.



Moving to the passenger side of the vehicle, loosen the thumbscrews on the computer monitor style DB9 connector. Disconnect this cable and hang to the side, out of the way.





Moving down to the DC connections, you will find a black plastic cover over the terminals. Use a Phillips screwdriver to remove the bottom screw. You will need to use a stubby Phillips screwdriver to remove the top screw, due to the limited space over the screw. Set the cover aside, with the screws.



Using the Phillips screwdriver again, you will remove the terminal screws from the DC cable connections. Pay attention to the routing of the cables, through the opening in the side of the cover assembly. When you reinstall the cables on the new charger, you will want the cables to be routed in the same way. Position the cables out of the way. You are now ready to begin removing the actual charger from the vehicle.

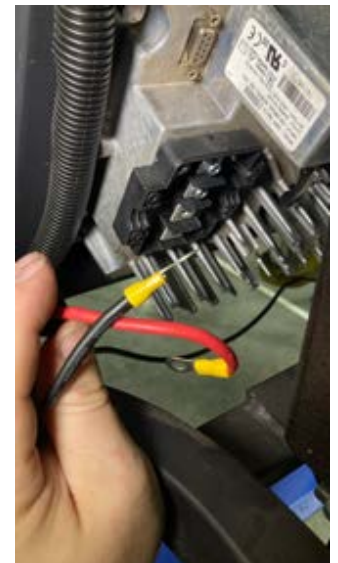

Using the ratchet and deep 10mm socket, you will remove the 4 bolts securing both ends of the charger to the firewall of the vehicle. When you remove the last bolt, the charger will be able to drop down, out of the opening in the frame.

The installation is the reverse of removal. But you will want to call attention to how the DC cables are routed through the lower section of their cover. As you can see, the red cable is curled around, to the far side so that it can lay alongside the black cable in the opening. In order for the cables to run through the opening nicely, this is how the red cable needs to be positioned. This will let the top cover come down properly, without pinching the either of the cables, and mate with the lower cover evenly.

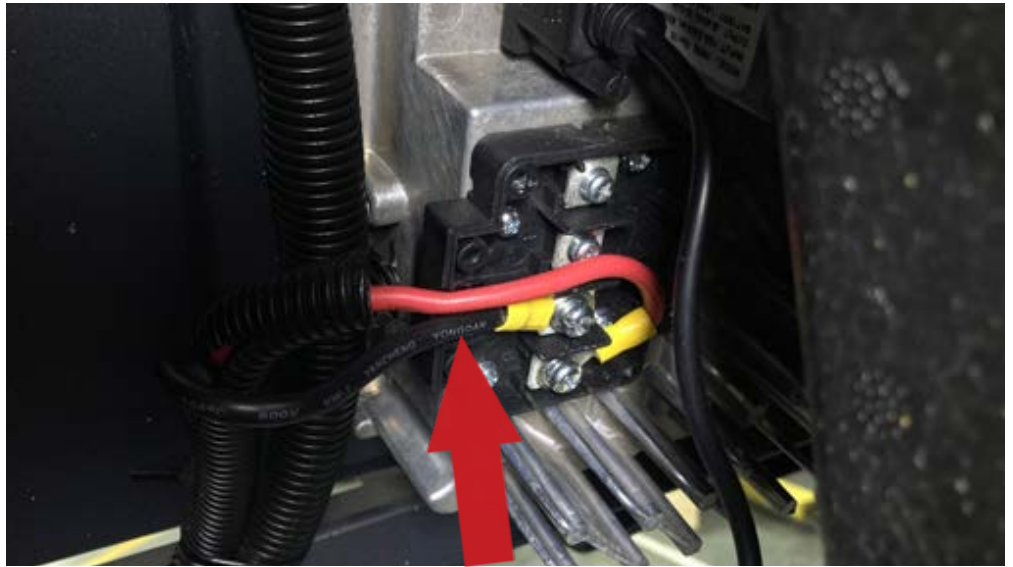

Replacing the Charger-Lithium



When replacing the lithium charger, you will need a ratchet with a long extension, a 13mm socket and a 13mm wrench, a 10mm socket, 10mm wrench and a Phillips screwdriver.



Start by disconnecting the charger cord from the battery. This is the cord with the blue twist-lock connector. This will break the connection between the battery and the charger.

Using the long extension, with a 13mm socket, you will reach down into the battery compartment and remove the two bolts that hold the charger legs to the floor of the compartment. You will need to use the 13mm wrench to hold the corresponding nuts below the floor of the vehicle. Remove these bolts and set aside for later.

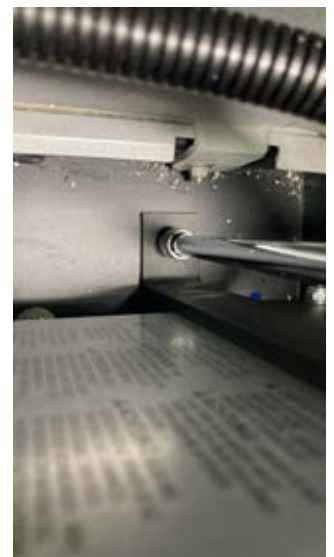



You will now loosen the thumbscrews connecting the computer monitor style DB9 connector to the charger. Disconnect the cable from the charger and position to the side.

Using the Phillips screwdriver, remove the screws from the black plastic cover that goes over the DC charging cable connections. Set this cover aside with the screws.



With the Phillips screwdriver, remove the screws from the DC charging cable terminals. You will set these screws aside along with the cables themselves.

Pull upward on the charger, so that you can access the small black retaining screw that holds the AC charging cord into the charger. This should be the last cable that is left connected to the charger. Unplug this cord from the charger.





The charger should now be free to lift out of the vehicle. Note the position of the feet on the charger legs. They face away from the charger cooling fins.

Using a ratchet with a 10mm socket, and the 10mm wrench, you will remove all the bolts that hold the charger legs onto the back of the charger.



When the legs are removed, these are how they will go back on. The feet point toward you, as shown, when installed correctly for the vehicle.

Install the legs onto the new charger. Note the position of the legs in the photo. Installation back into the vehicle is the reverse of removal. When installing the DC cable connections, be sure to orient the cables so they will not be pinched when installing the cable cover. Take care that the cables are aligned with the lower cover cable tunnel. This will ensure they are in the right place, once the top cover is replaced.



Batteries

Lithium:

There are currently three different lithium battery sizes in the Star Sirius line up. These batteries have been hand selected for their reliability and ease of use.

To turn on, each battery needs a key switch input, supplied through the red and black wires of the 4-pin connector. Then there is a power switch on the side of the 85Ah, 105Ah and 160Ah packs. And that's it! These batteries are relatively simple and straight forward.

They also feature a sleep mode, which is engaged after 1 hour of key input only, to conserve battery power.

The Star lithium battery warranty begins from the date of manufacture.

Lead-Acid:

The Star Sirius is also available with the venerable Trojan T-105 6V or T-875 8V lead acid batteries. These are superior cycling flooded lead acid units, with time tested performance and dependability.



Table of Contents

Lithium Battery Diagnosis	121
Checking Internal Voltage	125
Lithium Trickle Charging	127
Connecting to the Battery Using the Star Lithium App	138
Updating using the CAN box	149
Lithium BMS Installation	156
Lithium SOC Display	160
Lithium Pre-Call Checklist	161
Battery State of Charge	162
Battery Range Testing	163

Lithium Battery Diagnosis-Won't Power Up

For the Star Sirius Lithium 80Ah, 105Ah and 160Ah batteries to power up, they only need three things. These are:

- Key switch input.
- The battery power button depressed.
- Battery voltage must be above 15 volts.

For the 210Ah Lithium pack:

- Key switch input.
- Battery voltage must be above 15 volts.

Because there is very little needed, for these units to come on, it's relatively straightforward to diagnose a battery that won't power up.

For all the lithium batteries, the key switch connects pin 1 to pin 2, in the KEY/CAN/RS485 port on the side of the battery. To eliminate the possibility of a bad key switch, disconnect the black four pin connector, located about 12" away from the battery. This will be where the battery harness connects to the cart, near the frame rail.

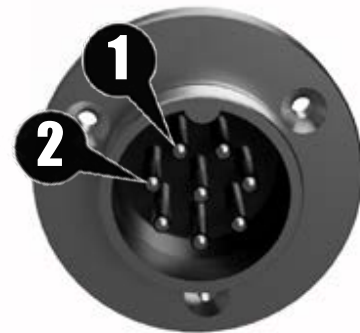

Next, use a jumper wire, to connect the red wire to the black wire. This will act as the key switch input. For the 210Ah battery, this is all that is needed for the battery to turn on, as long as the battery state of charge is above 15V. The internal battery solenoid should click, and the battery main cables will become live.



For the 80Ah, 105Ah and 160Ah batteries, you will need to jump across the same wires, have a state of charge of at least 15V, and the power button pushed in. If all three conditions are met, the battery power switch will illuminate and the battery main cables will become live.

If the batteries work as described, with the jumper wire installed, but not when connected to the vehicle, you will need to check the key switch wiring.

If the battery does not power up, even with the jumper wire installed, you will need to check the state of charge, inside the battery to make sure it is above 15V.

If the battery has the jumper wire installed, above 15V charge, and power switch pushed in for the 80Ah, 105Ah and 160Ah unit but still doesn't come on, perform a BMS board reset, and then retest. If problem persists, the BMS board will need to be replaced. (p.54)

Lithium Battery Diagnosis-Charger Not Working

The Star Lithium battery charger must have four inputs in order to work. These inputs are:

1. The battery must be able to turn on.
2. The charger must have AC power present via the charger receptacle.
3. The charger must have a DC power of at least 15V available on the DC side of the charger.
4. There must be a charger signal, to let the charger know it needs to come on.

To test for these inputs, turn the battery on, and connect a voltmeter across the two larger pins on the charger port. For 80Ah, 105Ah and 160Ah units, this should show full battery voltage. For the 210Ah unit, this should read 13-15 volts. This voltage is then supplied through the cord with the blue locking clip, to the charger DC connections. This travels through the red and black wires, to the charger. Verify the polarity is correct where the red and black wires connect to the charger, and that the same voltage you found above, is available at the charger. If it is not available, then there is an open circuit in the wiring.

Next, we will need to check for the charger signal. For this test, we will check for voltage across pin 4 and pin 5. For the 80Ah and 105Ah units, this should be 13-15 volts with the key on or off. For the 210Ah pack, this should be 3.3 volts. This signal travels through the cord with the blue locking clip, to the DB9 connector on the charger.

Once you have checked for voltage on the charger signal terminals, you can reconnect the cord with the blue locking clip, and move to it's other end with the DB9 connector. Check across pins 4 and 5, for the same voltage you found in the previous test. If you had voltage when testing at the charger port, but no voltage at the DB9, then there is an open circuit and the cord should be replaced.

If this signal is not provided to the charger, you will have a Comms Fault condition, no charger operation.

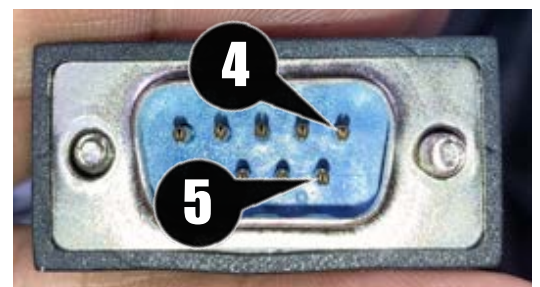

Now we will test the continuity of the rest of the charger cord terminals. There are four wires that need continuity. Two are for the charger signal, which carry power and ground. The other two carry a CAN high and CAN low signal.

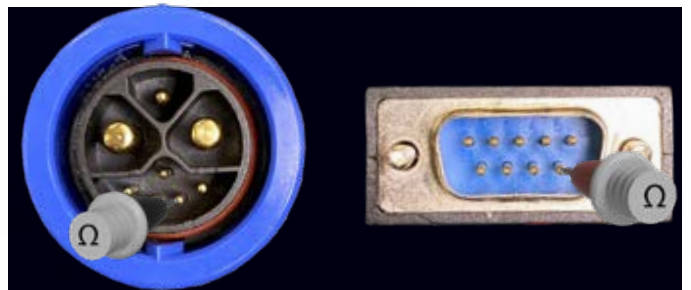
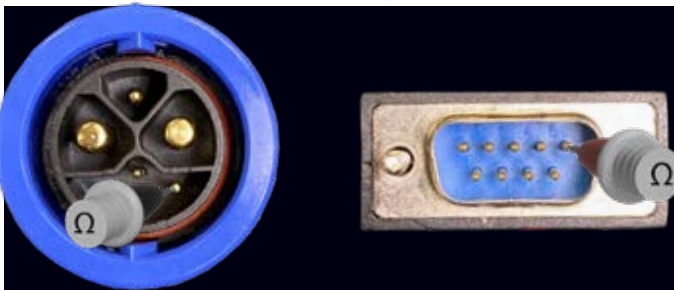
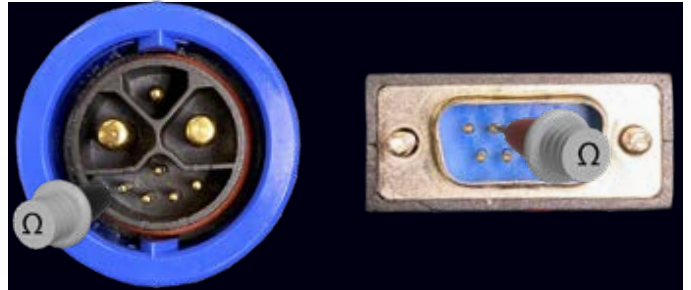
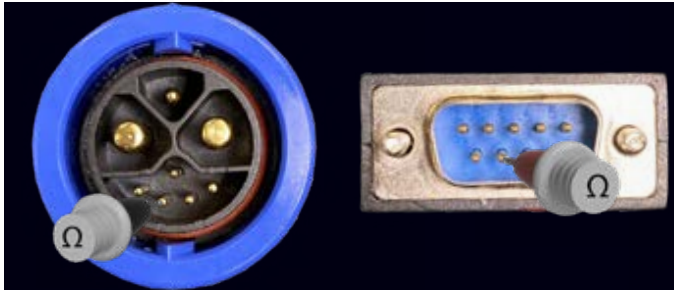

If you have continuity on all four of these wires, the cord has tested good, and can be ruled out as the cause of a no-charge issue.

Lithium Battery Diagnosis-CAN Signal

The Star Sirius Lithium battery uses a CAN (Controller Area Network) for communication with other components in the vehicle. The first of these is the steering column mounted display. If the display shows three red dots overlaid on the state of charge meter, it means that the display is communicating with the CAN network. If these dots are white, it means that CAN communication is not present. Be sure the display is plugged in, under the center dash cupholder.



The second component that uses CAN, is the sound generator. This noise maker was added in order to meet LSV requirements, but it can be unplugged without adverse effects to the vehicle or controls.



There is a wiring harness that connects these components to the battery, transmitting the signals to each. When testing the harness, there is a built-in resistance inside the system. This is called the termination resistor, and it's a measurable amount of resistance.

With the harness unplugged at both ends, you can test the resistance at each end. The readings should match what you see here. If your readings do not match these, then the wiring harness is suspect and should be replaced.

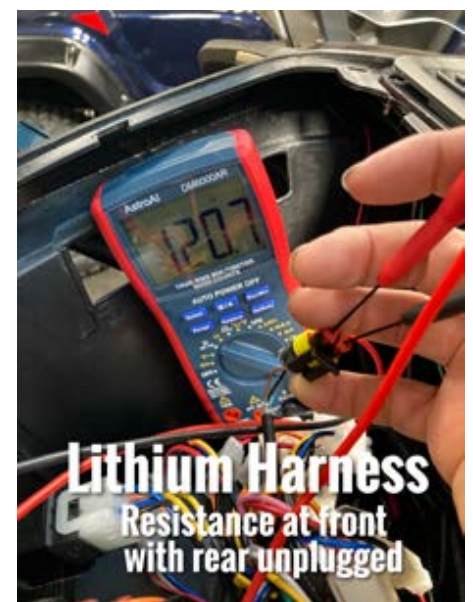

When the internal packs are visible, you will be able to use a voltmeter to check the actual remaining pack voltage. Set your voltmeter to DC volts. If your meter has a number value near the voltage option, you may need to adjust the setting according to the voltage in the battery, being tested. Be sure to connect the black lead to the common or COM port, and the red lead to the input or V port.



Now you are ready to connect the test leads to the main terminals where they connect to the lithium packs. Be sure to only contact the terminals and nothing else, when testing.

When connected to the main battery pack terminals, you will now know the internal state of charge.



Be sure to only contact the terminals and nothing else, when testing.



If the internal pack voltage is less than 15 volts, the battery will not turn on, and won't be able to be charged normally. This is why we will need to trickle charge it internally. The DT Smart Battery app will not work until this voltage is reached, so we can use it as an indicator that the voltage has reached the 15V threshold voltage.

Internal Lithium Trickle Charging

If the battery is below the 15V threshold, you will need to trickle charge the battery. If it is found that one cell needs to be charged, you may need to charge it individually. With batteries that are DTCK, DTDA Bluetooth IDs, you will need to trickle charge these internally. For the battery individual cells, they must be within .4V of each other. So you will begin by checking each cell's voltage. Note the one(s) that are in need of charging. Connect the cell charger to the cells that are too low, one at a time. Plug the adapter end into a standard wall outlet.

When connected to the cell in need of charging, you will see an LED below the charger's logo turn red. This will indicate that the cell is charging, and the LED will turn green when the cell has reached full charge.



It is IMPERATIVE that you use extreme care when connecting the leads of this charger to the cell terminals. Do not allow the other lead or the charger to dangle freely around the other cells! If accidental contact is made with another cell, etc, arcing and/or other damage will occur. Also, make very sure of the polarity of the cell terminals when connecting the leads! It is extremely important that you connect the leads safely.

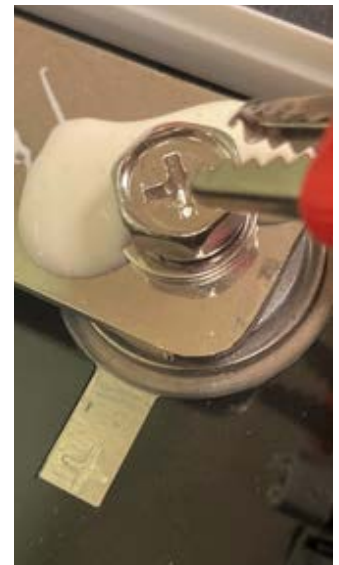

Once the cells are within the correct specs, you can connect the 2CH971 with alligator clips, to the main pack terminals. This charger will lift the overall voltage to 42V, which is where the Lester charger can take over and the app can connect.



The 2CH971 charger will need to have alligator clips added to it, in order to connect to the terminals inside the battery. To do this, you will simply cut off the chrome-plated screw on connector and attach the alligator clips to the corresponding colored wires. Once these are added, you can connect the charger to the battery main pack terminals.



Specific care should be taken to avoid contacting anything inside the battery with dangling cables, tools or the charger itself. You will connect the charger to the main pack terminals, via the alligator clips, and then you will plug the charger into a wall outlet. At this point, you can continue to the next section, as if you were charging with the external charger.

External Lithium Trickle Charging

The first step in trickle charging the Star lithium battery, is checking the Bluetooth ID. The IDs that begin with DTCK or DTDA did not have the internal provisions for trickle charging. So these batteries will need to be sent to Star EV and a replacement will need to be arranged.





If your battery is not one of these, then the following trickle charging steps will apply and can be followed.

For charging the Lithium battery, you will need the 2CH971 external charger. This charger is able to charge the battery through the BUZZER/GAUGE port on the side of the battery. **This is only applicable to batteries with a production date after February 2021.**





The BUZZER/GUAGE port is the one with 7 terminals. This is where you will connect the trickle charger. Connect the charger to this port, and then plug the other end into a wall outlet. There is no power switch on the unit, since it comes on automatically.

LED Color Chart	Description	Meaning	What to do
	No Light	Battery voltage is below 13V. Charger should feel warm to the touch. It will turn red once it reaches 13V.	Continue charging if charger feels warm to the touch. If charger isn't warm, charging is not happening. Stop charging if the charger doesn't warm up.
	Amber	Battery is too old to be trickle charged, or has a dead cell.	Battery will need to be replaced.
	Red	Battery is above 13V and being charged.	Continue charging until LED turns green.
	Green	Battery has reached maximum charge possible (42V) with the trickle charger.	Stop charging. Connect with Star lithium app and perform battery update. Then connect Lester charger to finish charging.
	Red-Green Immediately	Battery is at 42V, or this is a false green, indicating that the charger will not work with this Bluetooth ID.	If the battery is able to connect with the app, perform any updates. If this is not possible, contact Star Technical Support at 864-549-7224 for further assistance.

The battery must reach 42V before the Lester charger can take over. **Once the trickle charger gets the battery up to this voltage, you MUST do the battery update.** If the battery is not updated, it will falsely tell the charger that it has full charge, so the Lester will not turn on. Once the update is performed, the BMS will now send the ACTUAL SOC to the Lester and allow it to come on and charge the battery further.

The main things to keep in mind:

- Disconnect trickle chargers before turning battery on, to check if the battery app will connect.
- Do not try to connect both chargers at the same time. Disconnect all trickle chargers before using the vehicle's on-board charger.
- Refer to the Lithium Battery Troubleshooting guide, for testing the pin voltages on the side of the battery, or if you have any questions about testing the batteries.
- Also, be aware that you will need to use an adapter for 120V if these chargers are used internationally. The specs of each charger are shown below, so you will be able to see if your adapter will be able to provide what the chargers need in order to work properly.



Lithium-individual cell charger specs.



Lithium-internal/external pack charger specs.

Lithium Battery Troubleshooting



KEY/CAN/RS485

BUZZER / GAUGE

SWITCH

⊖

Battery Pack Voltage Testing

1. With key turned on, test for voltage between battery main positive and battery main negative. Voltage should be at least 37.5 volts. If the battery fails this test, go to next step.
2. With key on, place red voltmeter lead on pin 3, and black lead to pin 6. Voltage should be at least 37.5 volts. If not, battery is overly discharged and must be charged. This can be performed by opening battery case and attaching a 48V trickle charger, or by using the Green Energy external charger (PN: 2CH970).
3. With key still on, if volts are above 37.5, then use DT Smart Battery app to connect to battery using the QR code and Bluetooth ID number on top of the battery case. Use app to check BMS protection information. Verify that the "precharge failed" is not ON.



BUZZER/GAUGE

Key Switch Wiring Testing

1. With key turned on, pin 1 is connected to pin 2 through the key switch. In the key switch harness, there should be continuity from the red to black wire in the 4-pin connector going to the key switch with the switch turned on.
2. If there is no continuity, you can carefully jump pin 1 to pin 2 shown here, to see if the battery turns on. If it turns on with the jumper, then the issue is in the key switch or it's wiring.



KEY/CAN/RS485

Charger Voltage Supply Testing

1. Keep key on or pin 1 and pin 2 jumped from previous step.
2. In charger port, place red voltmeter lead in "+" socket and black lead in "-" socket.
3. For 80Ah and 105Ah batteries, volts should be full battery pack voltage.
4. For 210Ah batteries, volts should be 13-15 volts.

Charger Signal Testing

1. Keep key on or pin 1 and pin 2 jumped from previous step.
2. Place red voltmeter lead in pin 4 and black lead in pin 3.
3. For 80Ah and 105Ah batteries, volts should be 13-15 volts with key on or off.
4. For 210Ah batteries, volts should be 3.3 volts.
5. If these voltages are not as specified, suspect the BMS board.

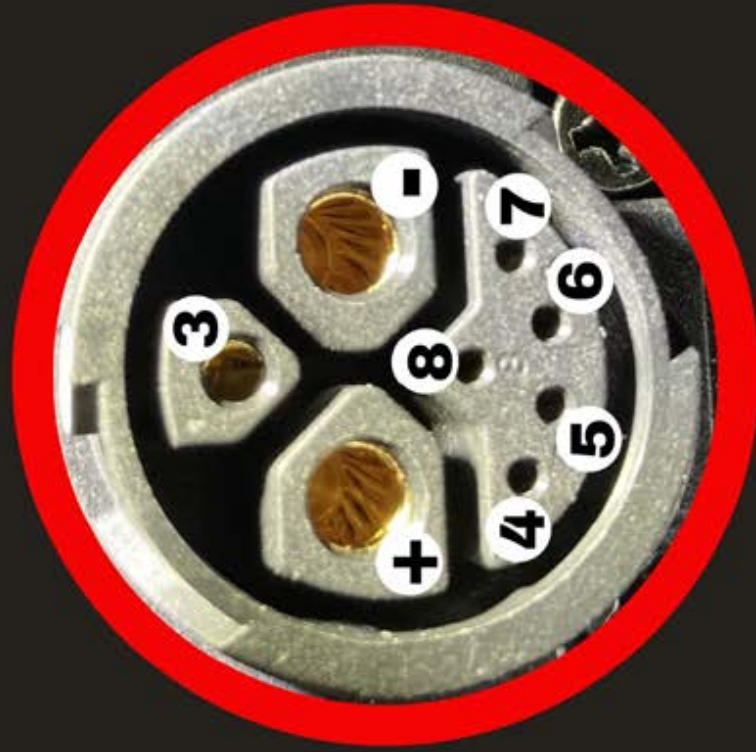

CHARGER PORT

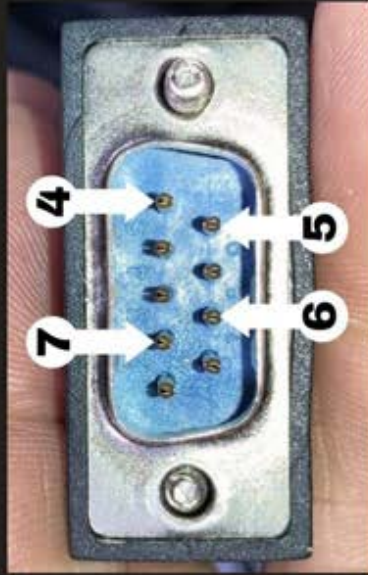
**CONNECT BLUE CHARGER LEAD****CHARGER MALE DB9 CONNECTOR**

Charger Harness Continuity Testing

1. With key on or pin 1 jumped to pin 2
2. Verify all previous tests have passed.
3. Connect charger cord with blue end, to the battery's charger port.
4. Place red voltmeter lead on pin 4 and the black lead on pin 5 of the DB9 connector shown.
5. Verify 13-15 volts are present for 80Ah or 105Ah batteries or 3.3 volts for 210Ah batteries.
6. If there is no voltage present, there is an open condition in the cord.
7. Verify that DB9 connector is going into the charger straight. This connector cannot be crooked or backed out, or there will not be a good connection. Refer to Star EV TSB# TE11017.00 for further details.

Sirius Lithium Wiring Diagram

The wiring harnesses needed to connect the lithium battery, into a Sirius vehicle are:

1. 1-2WH290 Key Switch Connector
2. 1-2CR020 On-board Charger Harness

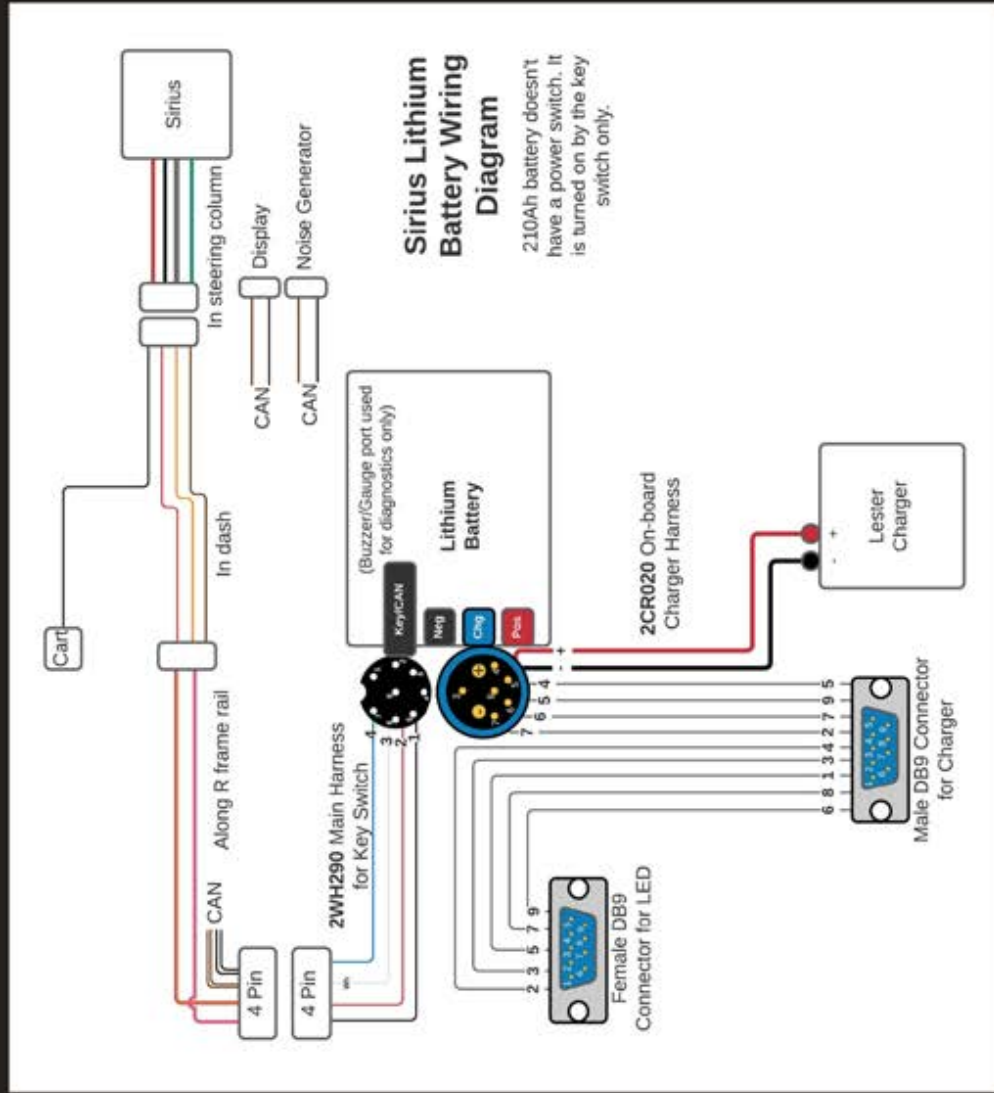

Connecting to the Star Lithium Battery via the Star Lithium app

Connecting to your Star Lithium battery is a very simple process. In this guide, we're going to demonstrate how you can do this with either an iOS or Android device.

From within the app, you can check for any faults, read the battery's temperature, check the actual state of charge and connect the battery to wi-fi for remote troubleshooting and updating from the battery manufacturer. Everything you need, is located on the top of the battery, for use with a smartphone.



Installing app via Android device



To begin, you will need to locate the Bluetooth ID number. Usually you will only need the last four digits. These will help you choose which battery to connect to, in case there are several batteries within your shop at the same time. For this example, our ID ends in '0125'.



Now, let's get the Star lithium app downloaded to your phone. If you have an Android phone, point your camera at the QR code for the Android. Currently, it is the middle QR code.

You will see a link pop up on your screen. You will click on this link, to be taken to the download site.



A new notification will pop up, asking if you'd like to download the file. Click Download.

Your phone will then ask if you'd like to install the application. Click Download.

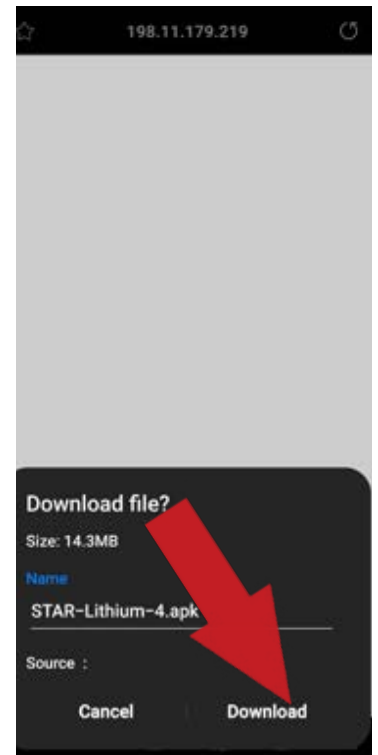
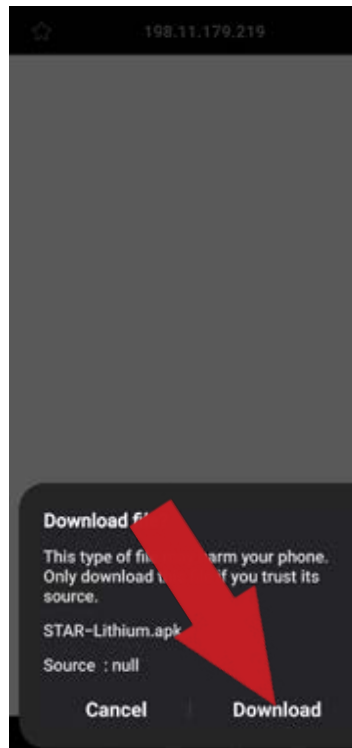

Now you'll see a progress bar showing that the file is being downloaded. After this step, you will see this notification saying that the file was successfully downloaded.

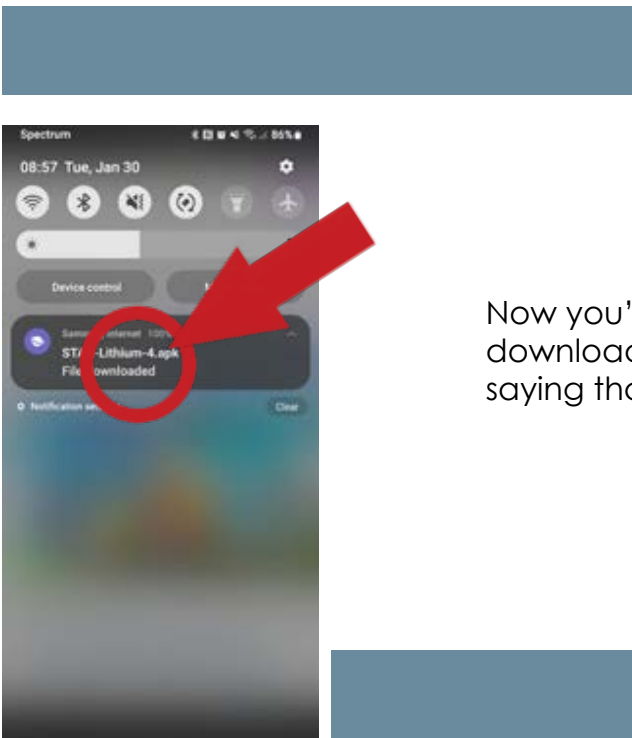

On the next screen, you'll be asked if you'd like to install the app. You will click 'Install'.

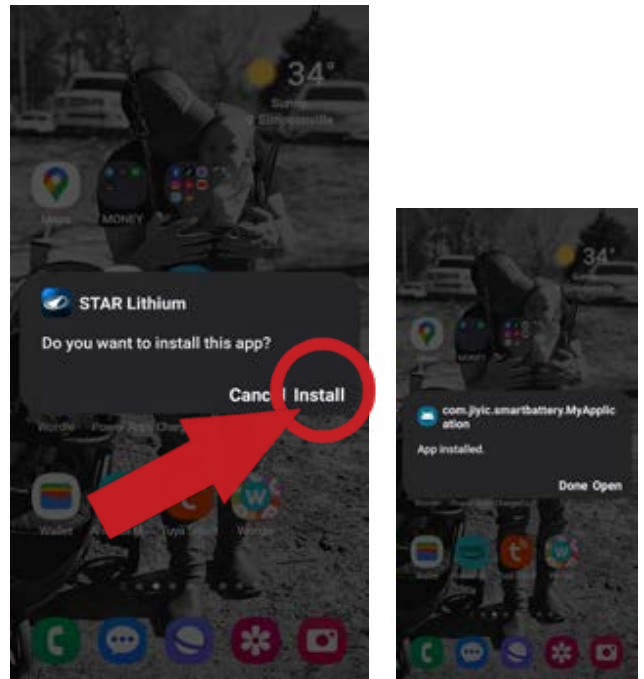

The app will ask if you'd like to grant access to your device's location. You can select either of the choices here. Typically, we recommend using 'While using the app'.

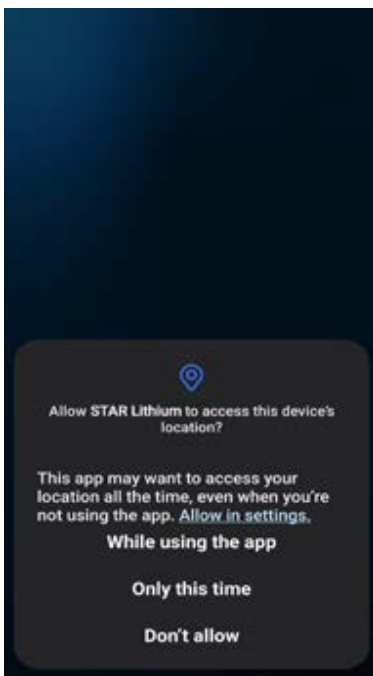

Once you've gotten through these preliminary steps, your app will ask if the app can access your files on your device. Click 'Allow'.

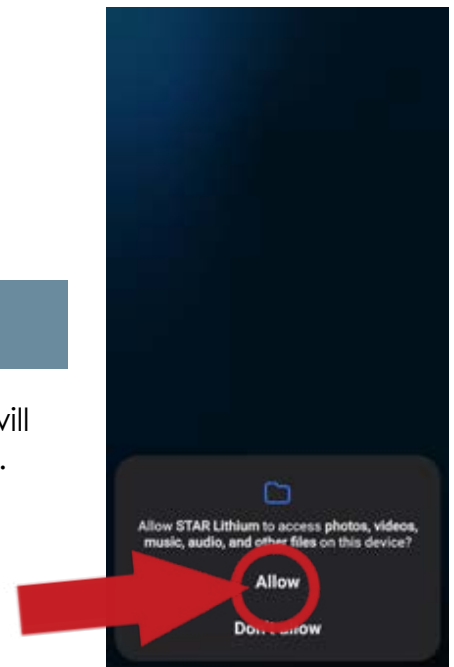



On the last screen, you will have the Star lithium app open, and there will be the 'Search for battery' button in the center. You are now ready to search for a battery to connect to.

Installing app via iOS device



To begin with the iOS version, you will need to locate the Bluetooth ID number. Usually you will only need the last four digits. These will help you choose which battery to connect to, in case there are several batteries within your shop at the same time.



Now, let's get the Star lithium app downloaded to your phone. If you have an Apple iOS phone, point your camera at the QR code for iOS. Currently, it is the rightmost QR code.



As soon as your iOS device camera recognizes the QR code, it will pop up a link which you'll click to be directed to the Star lithium app, for downloading.



Once you're at the app screen in the Apple app store, you will want to click the Get button. This will begin the download of the app to your device. Simply click 'Open' on the resulting screen.

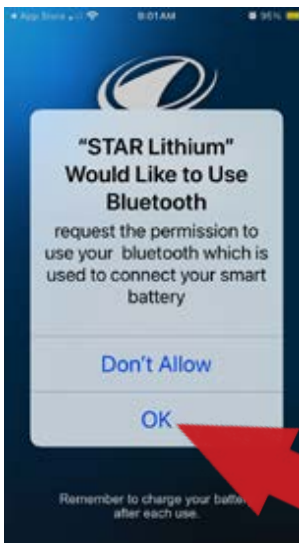

The app will ask prompt you for access to your Bluetooth connection. Click 'OK' to allow access.

From this point on, the Android and iOS apps will behave the same. It is only during the app installation process where they will differ.

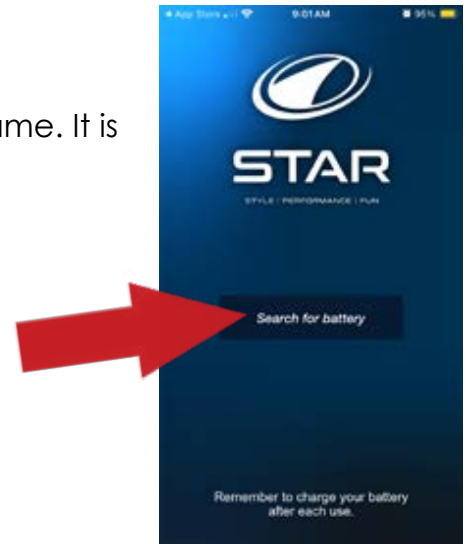

In your app, you will click on the button that says 'Search for battery'. This will show you a progress ring, showing that the app is searching for nearby batteries that can be connected to.



Using the DT Smart Battery app

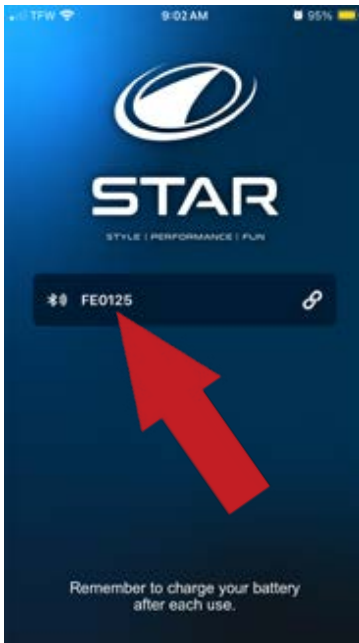

The steps will be the same in both versions of the app, whether iOS or Android. So from here we won't specify a particular operating system.

Click the button that says Search Device. This will bring up a list of nearby batteries that can be connected to. **NOTE: This will only list batteries that have their power switches turned on and their corresponding key switches turned on.**

If the battery you need to connect to doesn't turn on, you will not be able to connect to it, and you will need to diagnose the battery issue first. Please refer to the Star Lithium Battery Testing section of this manual for diagnostic steps.

Clicking the button to connect to the device, will bring you to the battery's main dashboard screen. Here, you will see some basic information. You will see the battery's state of charge, in a graphical form and a numerical voltage. You can also see the Celsius temperature of the battery. We will click on the 'View battery details' button, at the bottom of the screen.

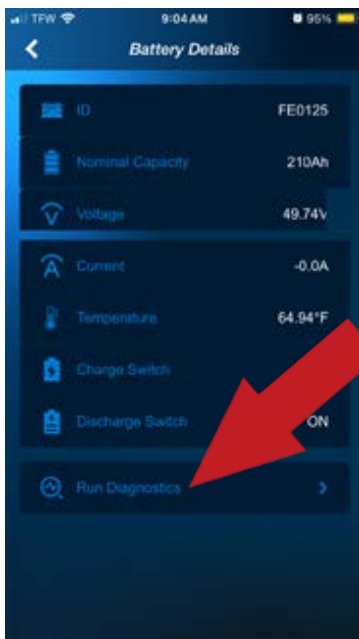

At the bottom of the new screen, you will see the 'Run Diagnostics' button. This will run a diagnostic self check, across all the battery's self protection circuits and report back whether it has passed, or if there are faults stored in memory.

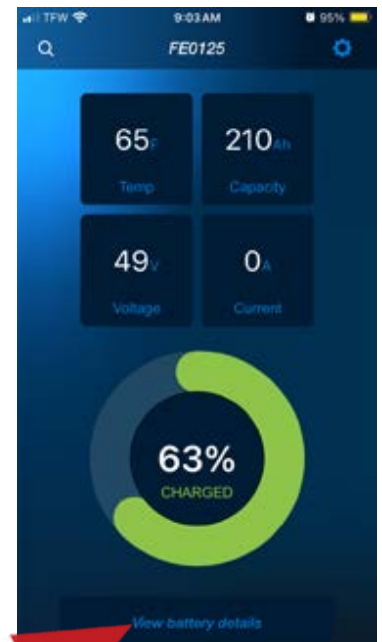

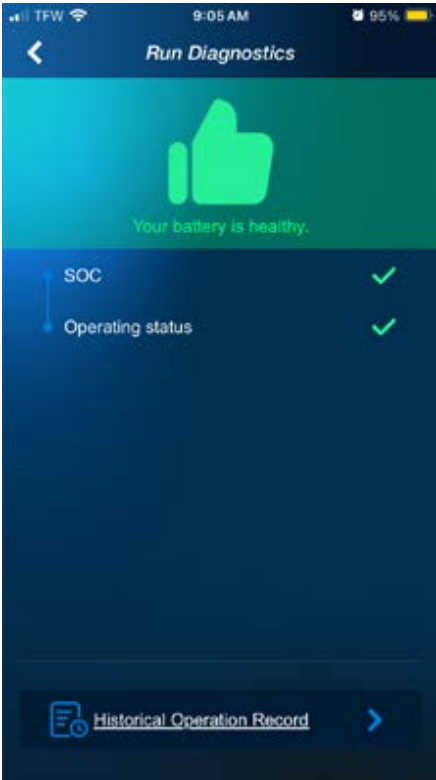

You will be brought to this screen that shows your battery has passed the tests, or additional troubleshooting is needed. At the bottom of the screen, you can click the 'Historical Operation Record' button to see what protections have triggered the faults, if any.

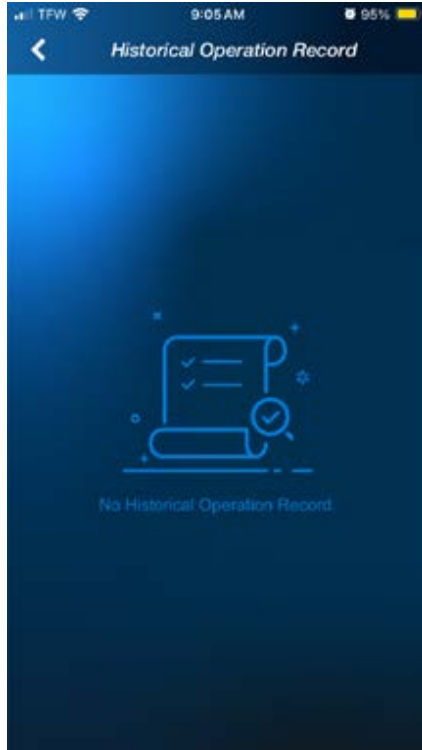

Watch: Amp draw testing using the Star lithium app

You can click the back button, at the top left of any screen, to return to the home screen. At the top right of the home screen, you will see the 'Gear' icon. Click on this icon, to be brought to the Setting page. The Setting page has the 'BMS Version Update' button, along with the 'Exit the app' button. We will concentrate on the 'BMS Version Update' button next.

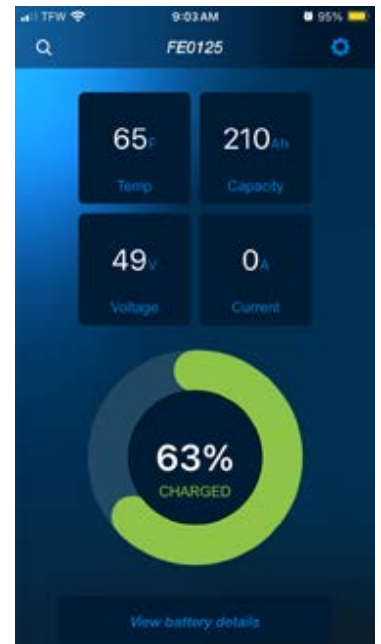

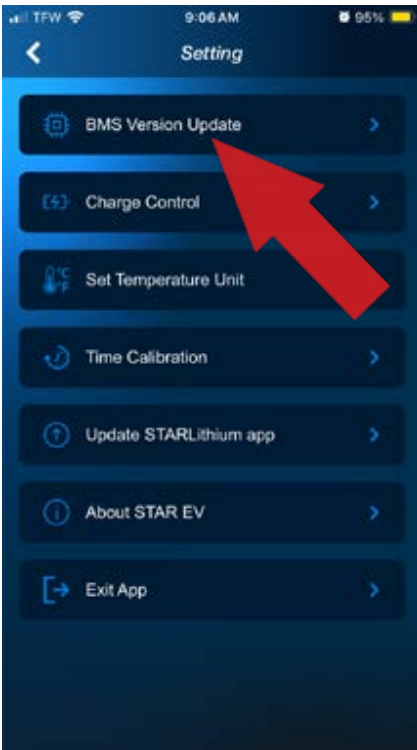

We'll look at how to connect your battery to Wi-fi and download any updates.

PLEASE NOTE:

1. You will need to have a 2.4Ghz connection on your wi-fi router.
2. You'll need to know the login and password for your router as well. Both dialog boxes where you will enter the login information, are case sensitive.
3. You'll need to be in range of your wi-fi router.
4. The WIFI Connect button will still say 'Confirm' once your wi-fi has been connected to successfully.
5. The app will also tell you whether your current version is the most recent one, and no update is needed.

After clicking on the BMS Version Update button, you will be brought to this screen. If you click 'Update,' the app can report whether an update is needed. But we will click 'Update Via WiFi' to demonstrate how to perform an update, in case one is needed. No damage will result, if an new update is performed over again.



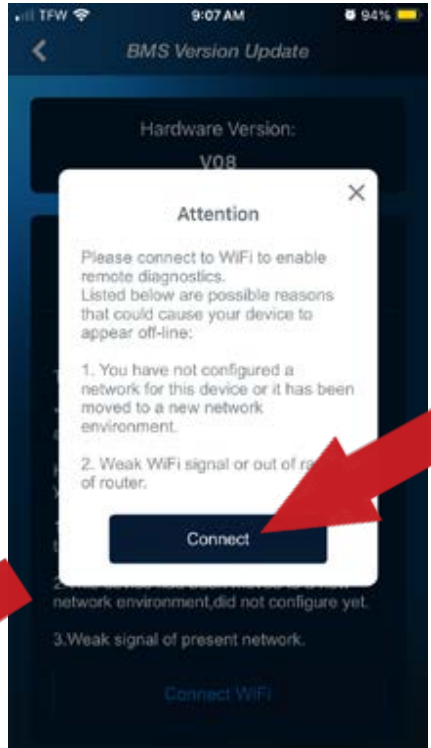

As you can see, in roughly the middle of the screen, this is already the latest version. But we'll show how to perform it so that you'll have the steps in the event an update is needed. Click 'Connect to WiFi' at the bottom, then 'Connect' at the bottom of the next pop-up window.



At this point, you will enter your wi-fi's login information. Both of the boxes are case sensitive. Once you've entered your login, click 'Connect' at the bottom of the screen.

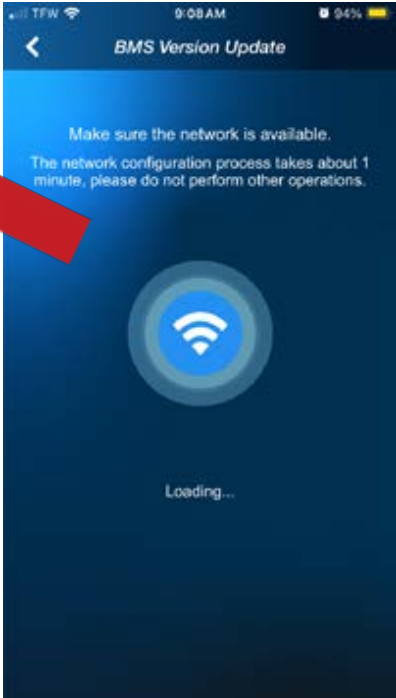

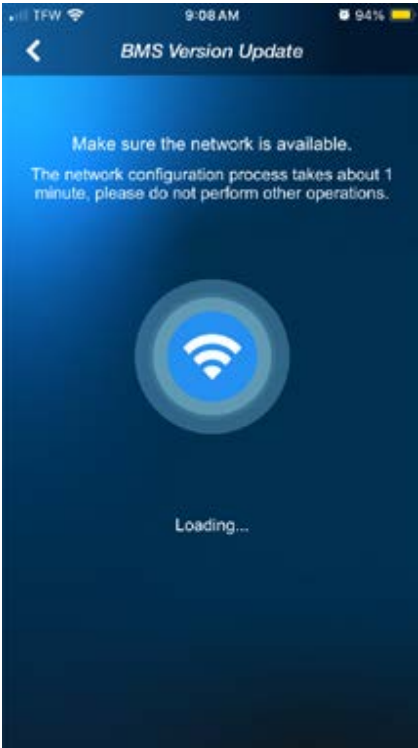

The app will begin the connection process, which may take about one minute to fully connect. You may also get a prompt that asks if the app can connect to nearby networks. Click 'Allow' for this operation.

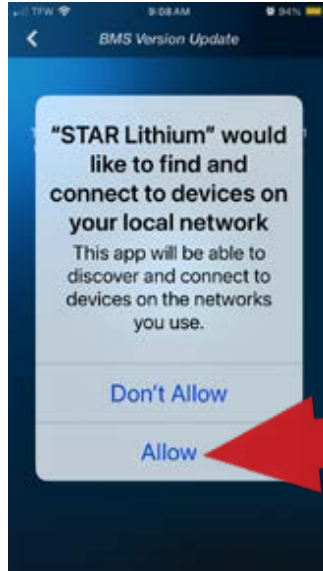

After the connection is made, it will continue on its own, without any more input from you or the app. You are able to disconnect the app, and go about your day. The battery and wi-fi will continue the conversation until the updates is finished. Simply click on the back arrow until you reach the main screen, then click the 'Gear' icon, then 'Exit app', then 'Yes'.

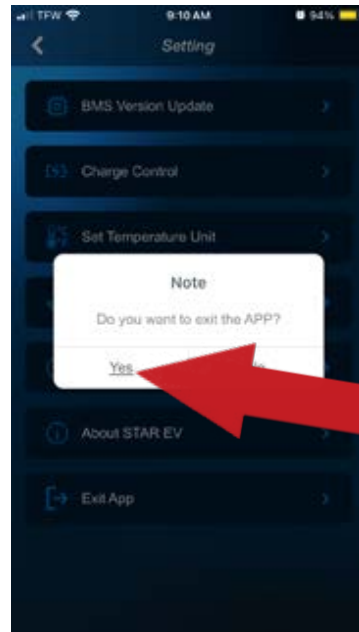
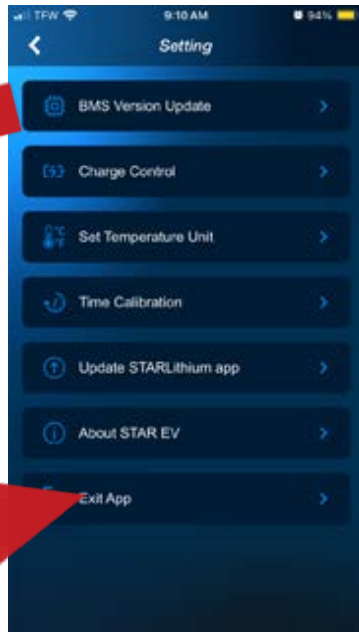

Your battery has now been updated to the latest version.

Updating the Star lithium battery with the CAN box kit

Besides using the Star lithium app, you can use the CAN update box kit. The advantage of using this method, is that you don't need access to wi-fi, or the phone app to be able to do it. So it's perfect for shops that have connectivity issues. What this update does, is add maintenance charging capability. So if you have a battery that has died while left on the charger, you'll want to perform this update on it.

To perform this update, you'll need to contact tech support for the battery update CAN box. The part number for that kit is 2BT250. And you'll also need to request the thumb drive that goes with it, so we can send it out with the box.

Once you receive your CAN box, this is what you'll see. There's the box itself, with a cord attached. Then you'll have a thumb drive, and you'll have a USB cord underneath the cardboard insert.



Insert the thumb drive into your computer, and open the drive from your file manager. Copy the entire folder off the thumb drive, to your computer desktop. This way you can remove the thumb drive, and have the software available right from your computer.

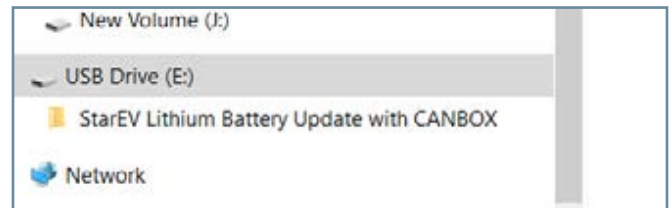

Opening the folder you copied to the desktop, you'll see some folders marked Install 1st, Install 2nd, etc. But you can go right to the bottom, and open the file that says 'Lithium Battery Software Upgrade Using.....' This will open a Word file with instructions that will walk you through the process step by step.

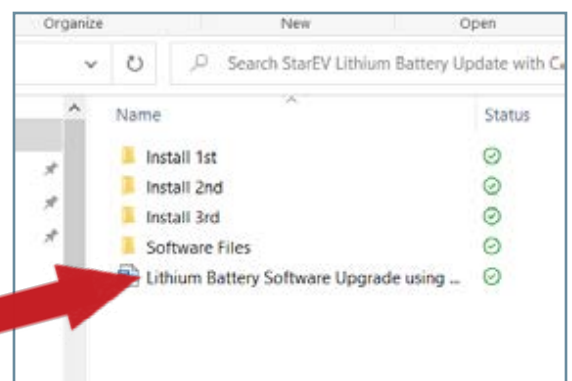
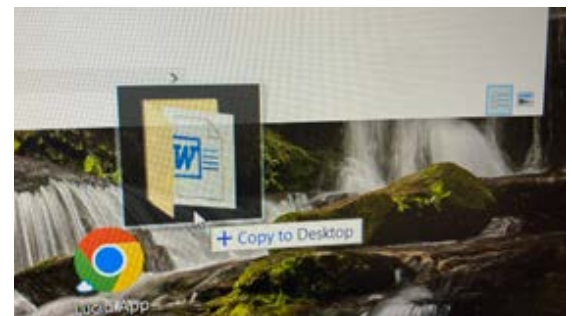

So let's start by going into the folder and clicking 'Install 1st'. Install this into your computer, following the on screen prompts. This will put this program icon on your desktop. It looks like a golf cart, as shown.

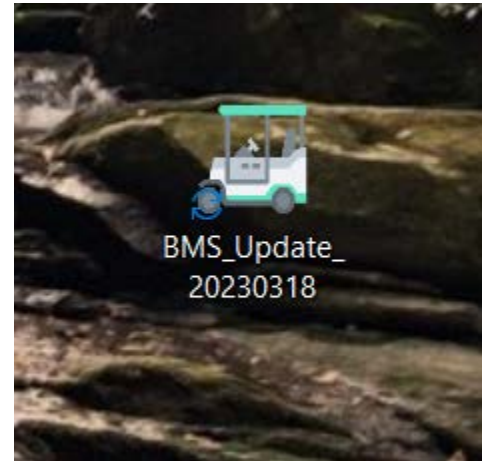

In the 'Install 2nd' folder, there are two files, one for a 64bit machine, and one for a 86bit machine.

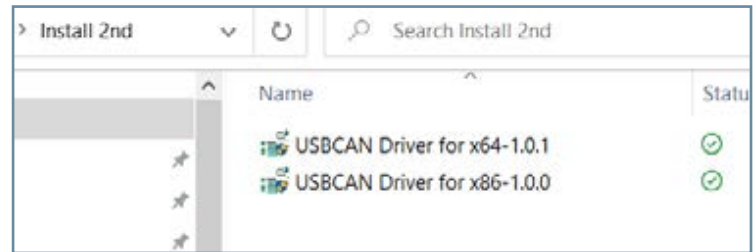

You will need to go into your computer settings, then system, then About. Under system type, you will see either 64bit or 86bit.

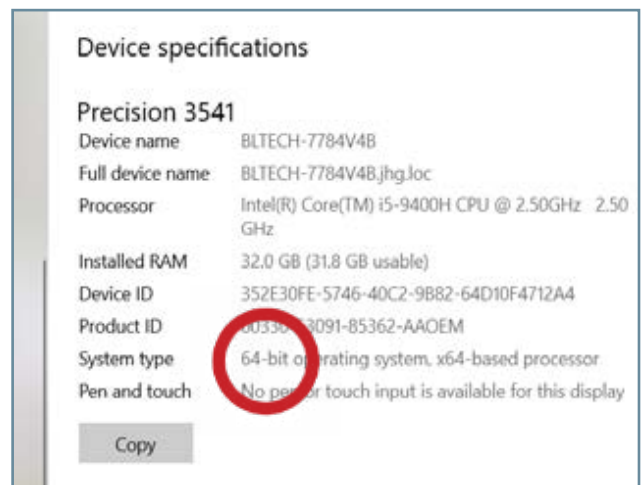
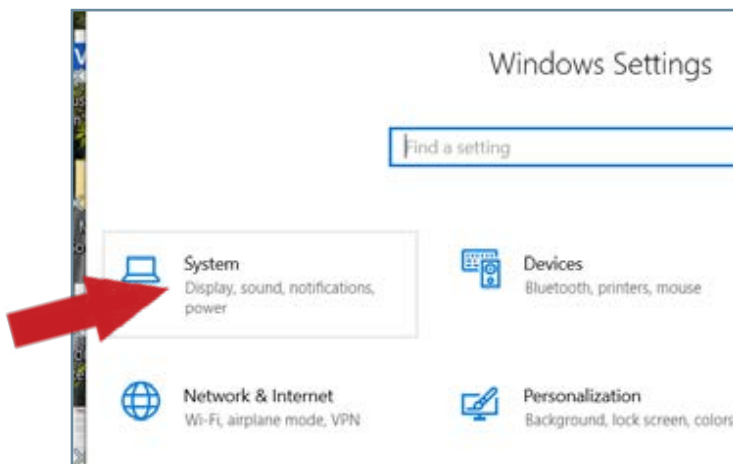
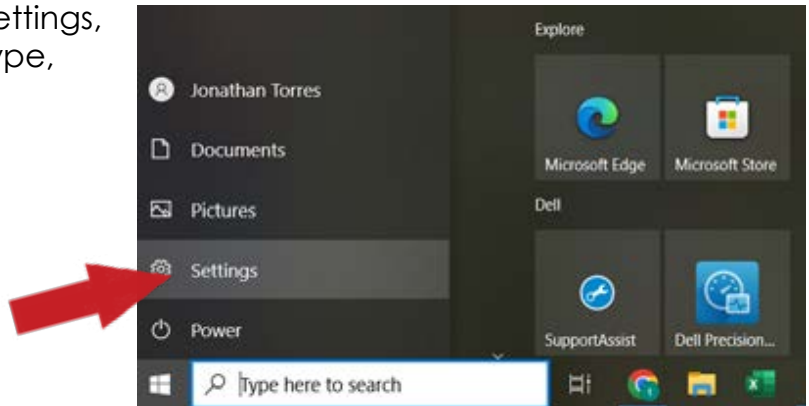

Now that you have this number, you will know which file to install from inside the Install 2nd folder. Once this is installed for a 64bit machine, you will not even need to proceed to the Install 3rd folder.

If you have an 86bit machine, you will install that file from the Install 2nd folder, followed by the corresponding 86bit file in the Install 3rd folder.

Once you've got all this done, you will get the USB cable out of the box, and connect it to the CAN box. It's located under the cardboard insert. Be sure to push the connector all the way in, otherwise you will see this error when you go to try to connect to the battery. Once you connect the USB end to the computer, you will see the lights on the CAN box light up like this, letting you know that everything is connected.



So let's start with how to tell what version update is already in the battery. First, you will connect the kit and use the Read Version button to show what's currently being used by the BMS. Carry your computer out to the vehicle you want to check, and update if it's required. I like to put my laptop on the passenger side floor, so it's out of the way.

You're going to plug in the charger to the vehicle. This will keep the battery on, and make sure that it doesn't run out of power during the update. Now, connect the CAN box cord, with the silver end to the BUZZER/GAUGE port on the side of the battery. Your computer should be connected to the battery now, with the CAN box in between.

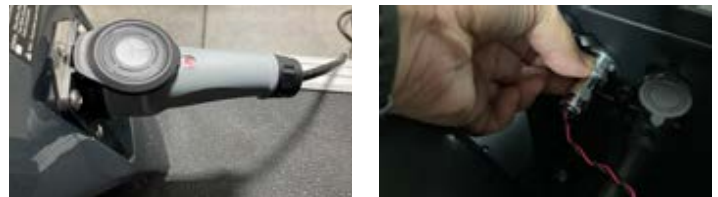

I like to have the software, and the Word document open on the screen side by side, so I can see both of them at the same time.





Double click the Golf cart icon for the BMS update software. This will launch the application, and open a prompt that will ask if the program can make changes on your computer. Click 'Yes' on this prompt.



This will launch the app and allow the computer to connect through the CAN box.

Once the application is open, you'll use the Start_Connect button over on the right. This will open the connection between the computer and the battery. Once this button turns green, there is communication going on. You will see one of the version boxes turn green also, for example the V05 button. This shows me that I'm dealing with a Version 5 board.

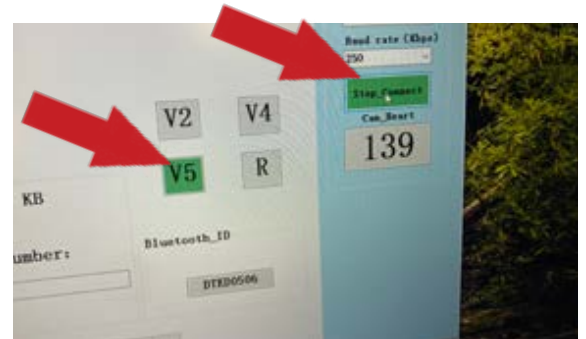

Now you can click the Read Version button. This will show you what data file is currently in the battery. If you scroll down to the bottom of the Word document, you will be able to compare what you have to the most current version for your BMS board. So if V05 lit up green, you will compare with the V05 version in the chart. Now if your version data doesn't match up, we're going to perform the update, so that they will match.

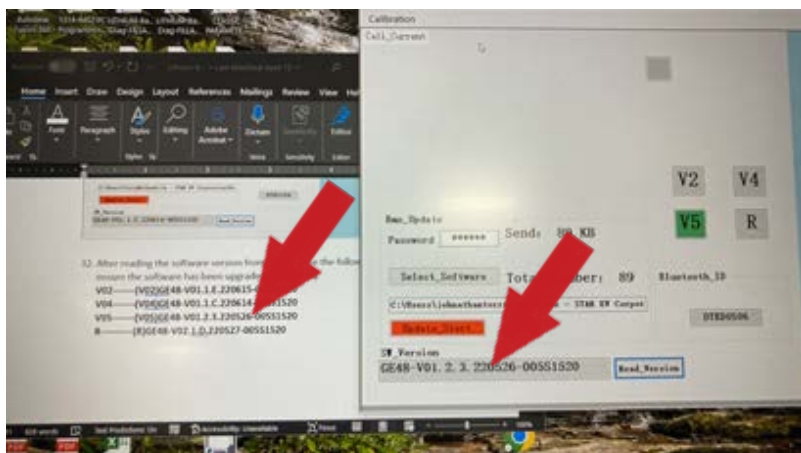
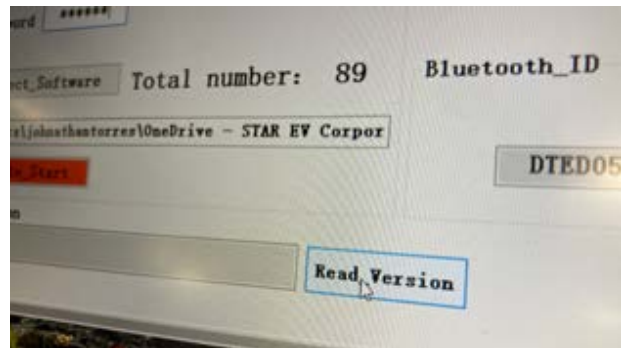

These are the two numbers that must match each other. In this case, I'm looking at the V05 line of the instruction sheet, and comparing it to the information in the Read_Version box. If I had a V04, I would refer to the V04 line of the instructions sheet, and so forth.

Now we're going to look at how to update the battery if these numbers don't match. To begin, enter the password 'energy' into the password box. Then Click the 'Select_Software' button. This will take you to browse your computer for the software that matches your BMS board. So if your board is a V04 in this case, you will choose the folder that says V04. But I've connected mine to a V05 board, so I'm going to choose the V05 folder.

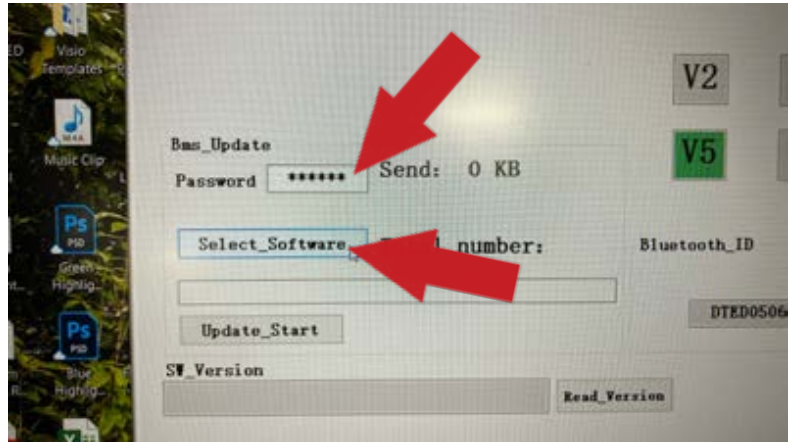

Once you click Select_Software, it will pull up your file manager. You will need to point it to where the software files are located. This will be in the folder we copied to the desktop in the first step in the process. So you will click Desktop, and then StarEV Lithium Battery Update with CANBOX.



You will then click on Software files, and then the version that matches the board that popped up in the previous steps.

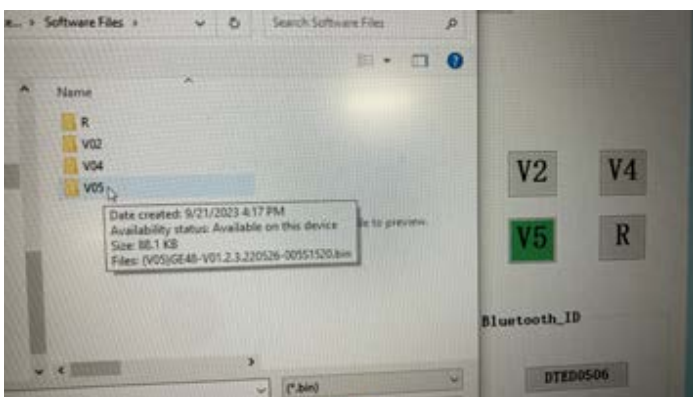

Because our board is a V05, I'm selecting the V05 folder. Inside this folder you will see a file. Click on this file and then click 'Open' at the bottom.

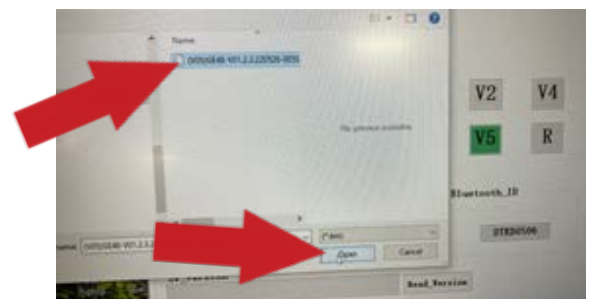

Once that software has been selected, it will show in the update box, ready to be written to the BMS. You will also be shown the size of the file. In my case it's 89Kb.

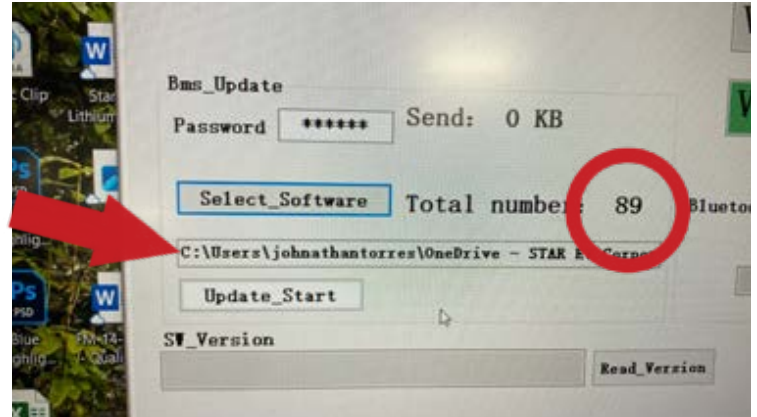

Click the Update_Start button. It will turn green, and you will see the Send amount start to climb. Once it reaches the full amount of data, in my case 89Kb, the update will be done.

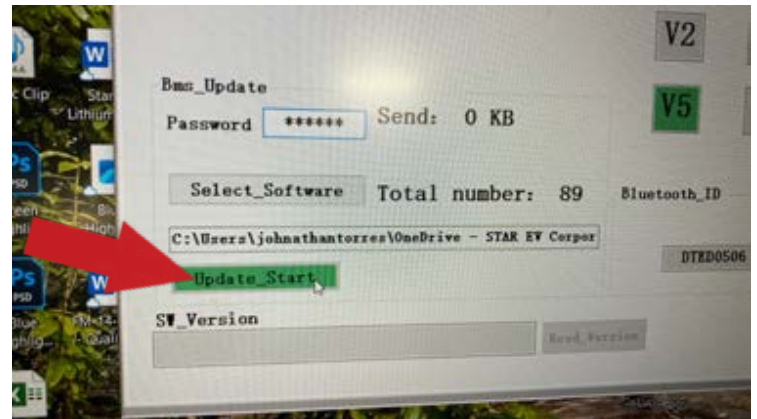

Once done, you will see a prompt that says 'Data transfer complete'. Click 'OK'. At this point, if the update has been successful, you can go into the phone app and look under BMS updates and it will show today's date, if you just did the update. Or you can click the Read_Version button and check it that way, like we did before.

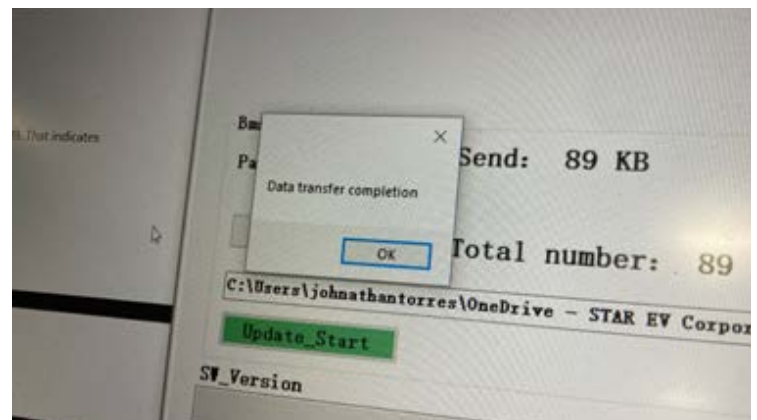

Now here are some frequently asked questions when it comes to the update:

Will it hurt to re-apply the update? No, it just won't accept it since it's already the current one. Are there batteries that this update won't work with? Yes, the CK series batteries can't be updated like this. So they just need to be sent back to us.

Once you've checked and made sure the update was successful, by using the chart at the bottom of the instruction sheet, or by using the app, you're free to close out the program and disconnect everything from the battery.

You can unplug the charger, and the vehicle is ready for return to the customer. Now I know this whole procedure may sound like a lot to do. But once you've done it a couple times, you'll see that it's not really that difficult.

We recommend checking each battery that comes into the shop for the update status. This can be done way easier with the Star lithium app, but this video will come in handy if you don't have cell signal, a smartphone, or wi-fi access.



Watch: BATTERY_Lithium_BMS update with CAN box

Lithium BMS Installation



Here are the tools you'll need, to remove the BMS board. The cutters are for cutting the zip tie on the small red wire, that extends over the BMS board. Also, include a flashlight and a 10mm socket with ratchet.

Be sure to use RTV sealant, when reinstalling the interior battery cover. This will keep dirt, debris and water from entering the battery case.



Begin by removing the 12 exterior screws, located around the edge of the top, exterior cove. Lift cover off, and set aside.



Once the top cover is removed, you will need to remove the six interior screws, located under the RTV sealant. These screws are located along the longer sides of the interior cover. Carefully pry up on the shorter edges of the interior cover, to remove cover once the screws are taken out. **DO NOT pry too deep, with your prying tools, so that you don't contact any components underneath the cover.**

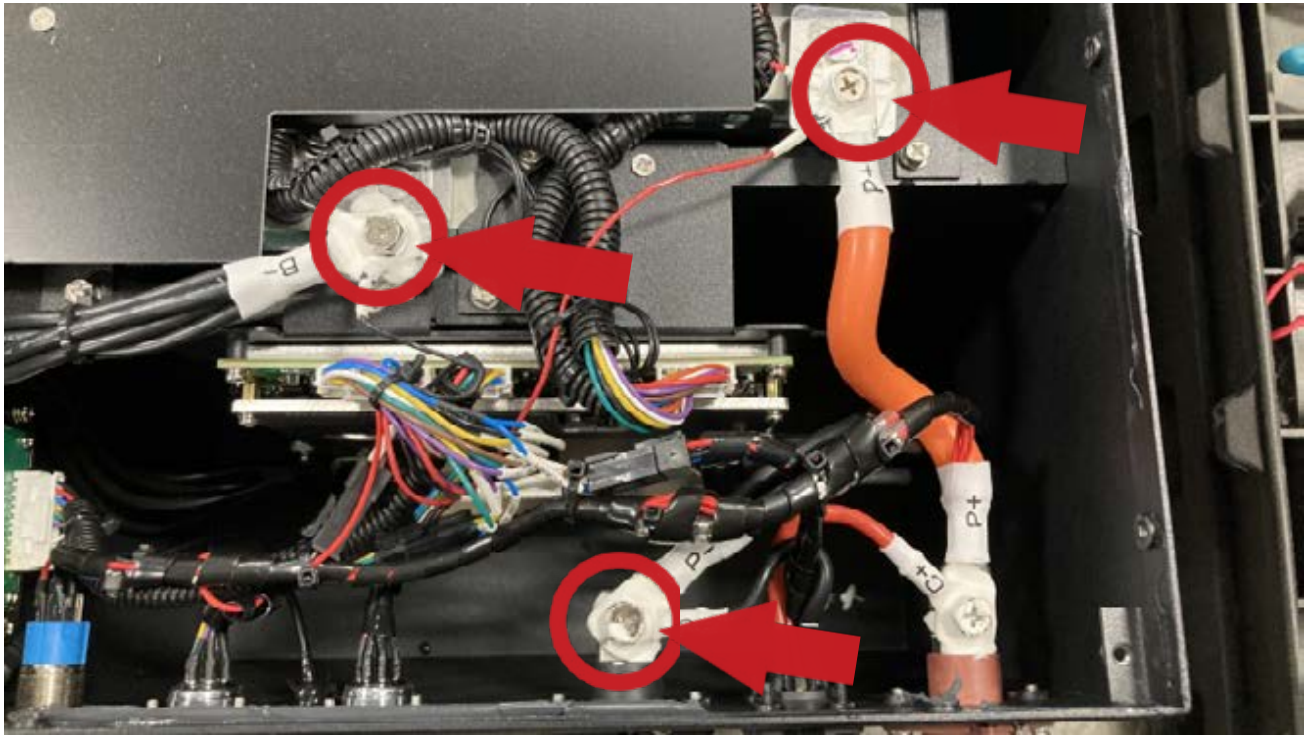

Begin by removing the three 10mm bolts that hold the larger wires, as marked by the arrows above.

Use a rag or tape, to cover the end of the red wire. It will not arc, when touched to metal, but we do this as a precautionary measure.

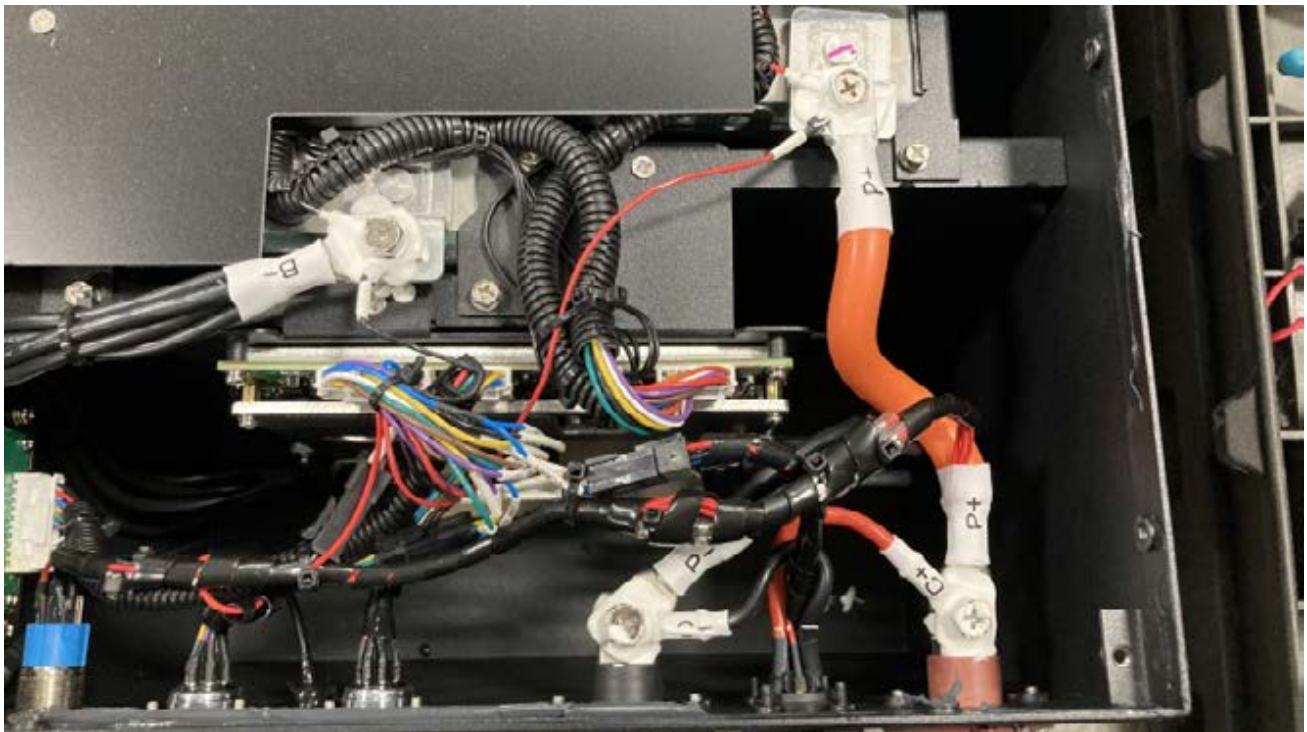

Remove the screws that hold the BMS mounting plate, into the battery case. You will need to separate the small red wire that passes over the BMS board, from the large positive terminal that you disconnected in the previous step. This will allow the BMS board to slide up and out of the case.

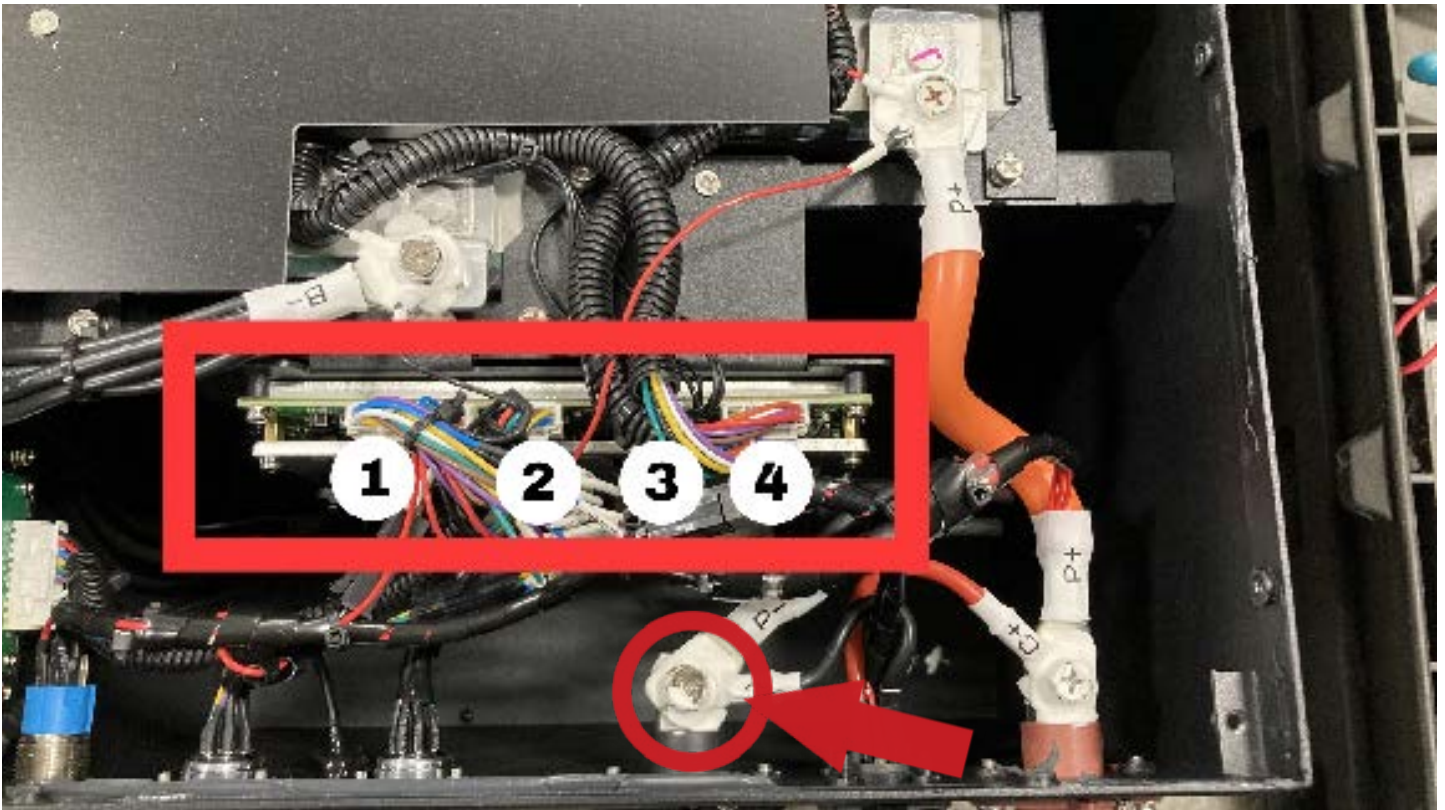

Starting with #1 above, disconnect the numbered wiring plugs, from the BMS board in order, from 1-4. And then separate the small black wire from the main ground lead you disconnected in the beginning steps.



As you slide the BMS board up and out of the case, you will need to be careful not to snag any wiring or terminals on the peripheral boards. As you come up, you will find that you need to disconnect the ground wire terminals on the right side. You will need to reconnect these to the new BMS board.

The ground wire group has one small black wire, and we've found that the case wiring has two. So this is why you'll need to use the case harness, instead of the one that's supplied with the BMS.

The bottom of the BMS board mounting plate locates on two pins, on the bottom of the case. You'll need a flashlight to see where these pins are. Be sure the mounting plate aligns on these pins when you reinstall.

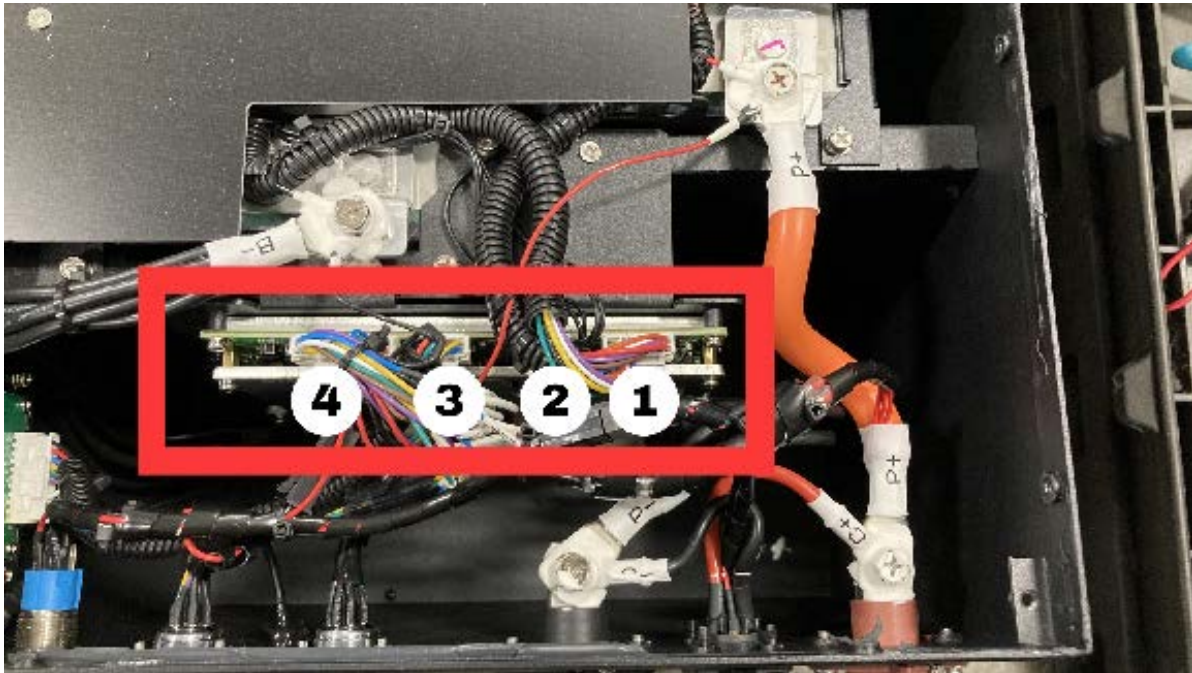

When reconnecting the wiring connections to the BMS board, you will reverse the order they were disconnected in, leaving the large white connector for last (#4). For best contact between the wiring connections, clean off the terminal tamper evident sealant from the eyelets. Be sure to re-seal the inner battery cover with RTV before reinstalling the outer cover.

Lithium SOC Display

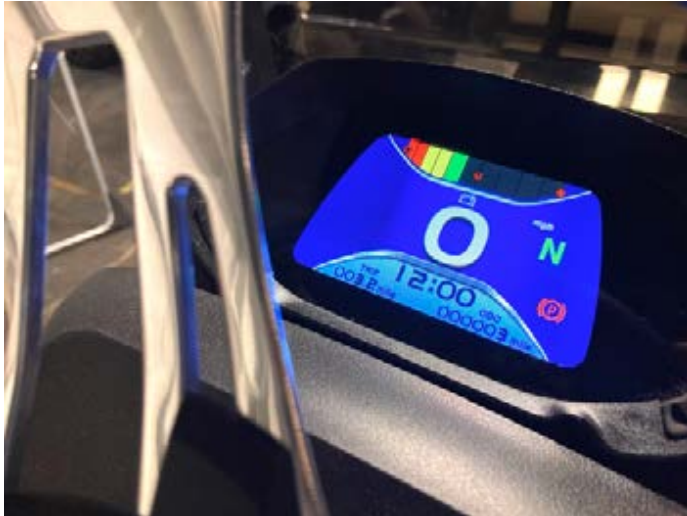

The Star Sirius display shows the state of charge, for the Lithium battery. Some owners may wonder if their Sirius display is showing an accurate measurement of the battery's charge level.

Here, we'll include a chart that documents the relationship of the display bars to the percentage of remaining charge.

Using the DT Smart Battery app, you can access the Star Lithium battery state of charge. This reading is sent to the steering column mounted display via a CAN network, directly from the battery. The display makes no calculations or interpretations of the data, only displays the data it receives.

The Star CAN Display of Lithium SOC is as follows:

- 0 bars: 0-4%
- 1 bar: 5%-19% flashing begins at 19%
- 2 bars: 20% - 29%
- 3 bars: 30%-39%
- 4 bars: 40%-49%
- 5 bars: 50%-59%
- 6 bars: 60%-69%
- 7 bars: 70%-79%
- 8 bars: 80%-89%
- 9 bars: 90%-94%
- 10 bars: 95%-100%

According to this data, the first two bars only represent 10% change in voltage combined. This means that the most significant amount of drop in bars will happen rather quickly. As the state of charge declines, each bar value actually improves, until there is one bar left. So the last bar translates into most of your battery's remaining life percentage, when measured against the other bars.

Lithium Pre-call Checklist



There are several pieces of information that Star EV technical support will need to know, when you call for Lithium battery assistance. We'll list those out below. When you call, it will be very helpful to have these ready.

Also, it would be helpful if you're by the vehicle when calling so that we can have you follow direct instructions straightaway. This will speed up the diagnostic process for you greatly.



What to check before calling:
What is the size of the battery?

80Ah 105Ah 160Ah 210Ah

For the 80Ah, 105Ah and 160Ah batteries, does the battery power switch come on and illuminate when pressed, with the 4-pin connector jumped across the red and black wires? Yes No

For the 210Ah battery, does the battery come on and click internally with the 4-pin connector jumped across the red and black wires? Yes No

What is the Bluetooth ID number of the battery? _____

Is the Star lithium app able to connect to the battery? If so, what is the state of charge?

If the app is not able to connect to the battery, have you tried trickle charging internally or externally? Yes No

What is the voltage across the large main battery terminals? _____

What is the voltage across the larger charger pins? _____

What is the original concern that brought the vehicle in for service? _____

Battery State of Charge



All Star carts need to be fully charged prior to delivery to the end user. On the Sirius steering column display, you will see three red dots overlaid on the battery meter bars. These dots indicate a CAN connection with the battery. If these dots are white, then there is no communication with the battery, **and the state of charge will not be accurate. It is important to note that the time clock will reset every time the key is turned off, on earlier models, due to the Lithium battery turning off completely to preserve battery power.**



For the lead-acid vehicles, the batteries must be fully charged in order to properly calibrate the Sirius display. On the Sirius display, you will see white dots overlaid on the battery meter bars. This is correct for the lead-acid vehicles, since there is no CAN network. There is a break-in period for the lead acid vehicles, which typically lasts 20-30 charge cycles, to fully maximize the battery range.

Lithium Range Testing

The Star Lithium range test consists of fully charging the battery, setting the trip meter and driving the vehicle until only the last red bar is visible. Be sure to be near your facility at this time. For the lithium batteries, the expected ranges are as follows:

80Ah	105Ah	210Ah
2+2 20-25 miles	2+2 40-45 miles	2+2 85 miles

Factors that will keep the cart from getting these ranges are:

- Brakes dragging in front or rear
- Wheel bearings dragging in front
- Low tire pressure
- Battery is undersized for the vehicle length

A battery's range will be drastically shortened if there is excessive amp draw being demanded from the battery. To check for this amp draw, connect the Curtis handheld programmer to the vehicle. Go to Monitor, then Controller, then Current RMS. Driving on flat ground, at full speed, you should see:

Sitting still on flat ground	10-15 amps
2/2+2 cart	65-75 amps
4/4+2 cart	75-90 amps

If the amp draw is higher than these readings, you will need to use an infrared thermometer to check the temperatures on the brake parts. If one wheel is hotter than the others, then the dragging brake has been identified. This is the place to begin adjusting the brakes. A dragging wheel can also be caused by a tight or dragging wheel bearing in the front of the vehicle. Inflate all tires to 20 psi.

Once these issues are fixed, re-test the vehicle for the amp draw test, to make sure it is within the specifications.

With a longer car length, expect these values to change. As an example, for a 4+2 cart, with a 105Ah battery, the range will be roughly 30 miles instead of 40-45 miles.



Watch: Using an IR thermometer to check for brake drag

Replacing Lead Acid Batteries



For replacing the sealed lead acid batteries, you will need two 13mm wrenches, impact wrench with an extension, 13mm deep and shallow sockets, 14mm deep and shallow sockets, a ratchet, a torque wrench and battery lifting strap.

A good practice is to take a photo of, or make a diagram of how the batteries are oriented and how the cables are connected before beginning.



With the impact wrench, extension and 14mm deep socket, you will remove the attaching nuts from the main battery terminal posts. Disconnect the main battery cables and position to the side, so that they are away from their respective terminals.



Continue with removing all the cable attaching nuts, now that the main cables are safely disconnected and set aside.



Using the impact wrench, extension and 13mm deep socket, remove the nuts that retain the battery holdowns in place.



The ratchet will help to access the front nuts that retain the battery holdowns, under the lip of the front seat.



Moving to the battery holdowns that are toward the center of the battery pack, you will use the same tools to remove their retaining nuts.



Pull upward on and remove all the battery holddowns, and set them aside.



With the battery lifting strap, carefully remove each battery from the vehicle until the battery compartment is empty. It is easiest to start with all the batteries that are toward the front of the car first, followed by the rear ones.



When reinstalling the batteries, put in the ones toward the back of the car first. Then, take the holddown clamping bolts and slide them between the batteries, so they will remain out of your way while installing the front batteries. Once you have installed all batteries, refer to the torque specs in the rear of this manual.



Lead Acid Date Chart

Code	Month	Year
A3	January	2023
B3	February	2023
C3	March	2023
D3	April	2023
E3	May	2023
F3	June	2023
G3	July	2023
H3	August	2023
I3	September	2023
J3	October	2023
K3	November	2023
L3	December	2023

Each Trojan battery has a two digit code engraved on one of its terminals. The code is alphanumeric, with one letter and one number. In the images below, you will see examples of the engraving.

Each letter corresponds to a month of the year, and the number corresponds with a year. So you can see from the chart to the left, that these two batteries were made in May and June of 2023.

You can use this code to determine the age of the battery, from the time of manufacture.



Replacing the Lithium Battery

To replace the Star lithium battery, you will need an impact wrench with an extension, a torque wrench, 13mm socket, and a ratchet.



Begin with removing the seat bottom cushion.



Press the power button on all batteries except the 210Ah. This will turn the battery off. Then unscrew the chrome plated key switch connector, where it connects to the battery, and set aside.



Disconnect the blue twist-lock connector for the charger harness. To unhook this connector, push toward the battery, and turn counterclockwise. Set this connector aside.



Use the 13mm socket and ratchet to remove the main battery cable bolts. Disconnect the two main battery cables and set aside.



Using the impact wrench, extension and 13mm socket, remove the four battery mounting bolts. Capture all the washers and lock washers that are with these bolts, for reinstallation later.



It is best practice to have an assistant help lift the batteries out of the vehicle, to prevent injury and protect the painted surfaces of the vehicle.

Installation is the reverse of removal, except for using a torque wrench when doing the final tightening of the main battery terminal bolts. The torque spec for these bolts can be found at the back of this manual.



MCX Controllers

To program the MCX motor controller we will need to make a serial data connection from a Windows computer to the motor controller programming port. We will also need the MCX software installed and setup on the computer. Once we complete the connection to the motor controller, the software will provide a button at the top of the screen for Calibration. Then we will get multiple options of buttons for groups of parameters.



Most of the drivability settings are in Zonal Gear Mode. We have the option to select P-Maximum Forward Speed (rpm) to adjust the high-speed motor RPM limit. We can also adjust E-Maximum Forward Speed (rpm) for the low-speed motor RPM limit. To change these values, we need to click the appropriate line in the set value column and type in the new value we want to set this parameter to.

Then we need to click the

Set button at the bottom of the screen to make these changes live in the motor controller.

The screenshot shows the MCX software interface with a table of parameters. The table has columns for Parameter Name, Min Value, Max Value, Value, and Set Value. The 'P- Maximum forward speed(rpm)' row is highlighted in blue.

Parameter Name	Min Value	Max Value	Value	Set Value
The speed of 2 partition(rpm)	100	6000	1514	1514
The speed of 3 partition(rpm)	100	6000	2271	2271
The speed of 4 partition(rpm)	100	6000	3028	3028
The speed of 5 partition(rpm)	100	6000	3785	3785
The speed of 6 partition(rpm)	100	6000	4542	4542
The speed of 7 partition(rpm)	100	6000	5300	5300
P- Maximum forward speed(rpm)	100	6000	3750	3750
P- Maximum reverse speed(rpm)	100	6000	1500	1500
E- Forward maximum speed(rpm)	100	6000	2300	2300
L- Maximum reverse speed(rpm)	100	6000	1500	1500
S- Forward maximum speed(rpm)	100	6000	2300	2300
S- Maximum reverse speed(rpm)	100	6000	1500	1500
Maximum torque limit of 0RPM(%)	10	100	100	100
Maximum torque limit of 1 partition point(%)	10	100	100	100
Maximum torque limit of 2 partition point(%)	10	100	85	85
Maximum torque limit of 3 partition point(%)	10	100	80	80
Maximum torque limit of 4 partition point(%)	10	100	70	70

The other commonly adjusted settings are the accelerations settings. These are listed in the same section and follow the P and E mode, the same as for the maximum speed limits. These are also broken down into seven partitions allowing us the ability to adjust the acceleration settings at different RPM partitions. An example of a need for this

ability would be where you may want full acceleration at 4000 RPM while driving on the road at 20 MPH (32 KPH) but this acceleration rate at 0 RPM while starting off from a stop sign would not be appropriate and would likely accelerate too harshly.

Overcurrent Faults

We are in the process of fine tuning the MCX controller settings for an overcurrent issue. At this time, the TSB will be released as #TE11024.02. As future refinements are made, we will update these TSB's as needed. These documents are available on our dealer portal, at www.starev.com.

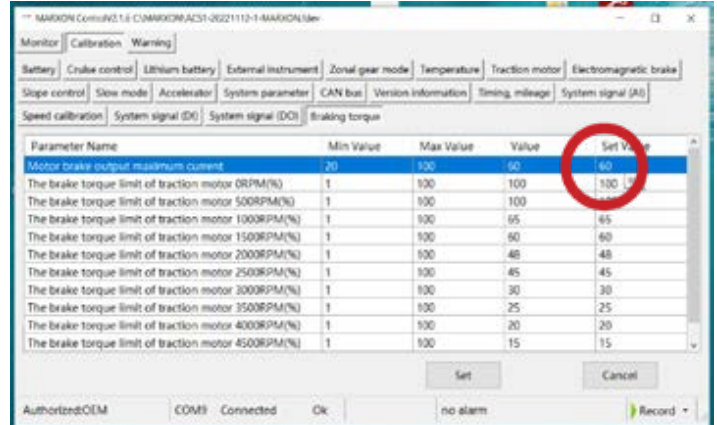
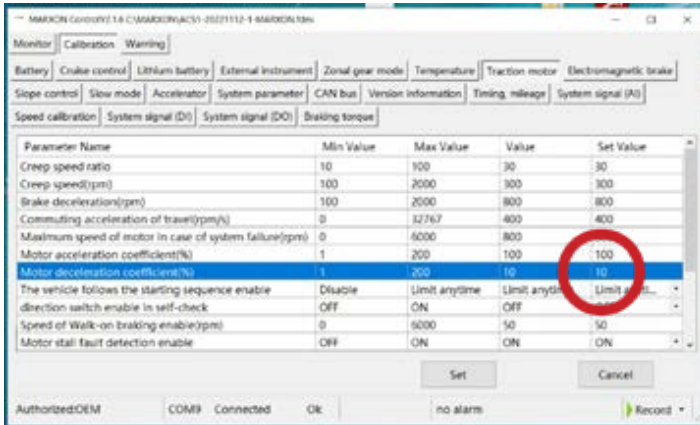

As shown above, you will navigate to the calibration tab, click on the 'Traction Motor' tab and click the cell for motor deceleration coefficient (%) 'Set Value'. Change this value to 10. Once the value has been changed, click on the 'Set' button at the bottom of the screen.

Next, while still in the calibration tab, click on the tab labeled 'Braking Torque'. Under motor brake output maximum current, click in the cell for 'Set Value' and change the value to 60%. You can now click the 'Set' button at the bottom of the screen to enter the changes.

With these changes, we are adjusting the amount and rate of regenerative braking that's being output by the motor, under certain driving conditions. If not corrected, this fault can cause the vehicle to cut off during long periods of coasting.

Updating MCX Firmware

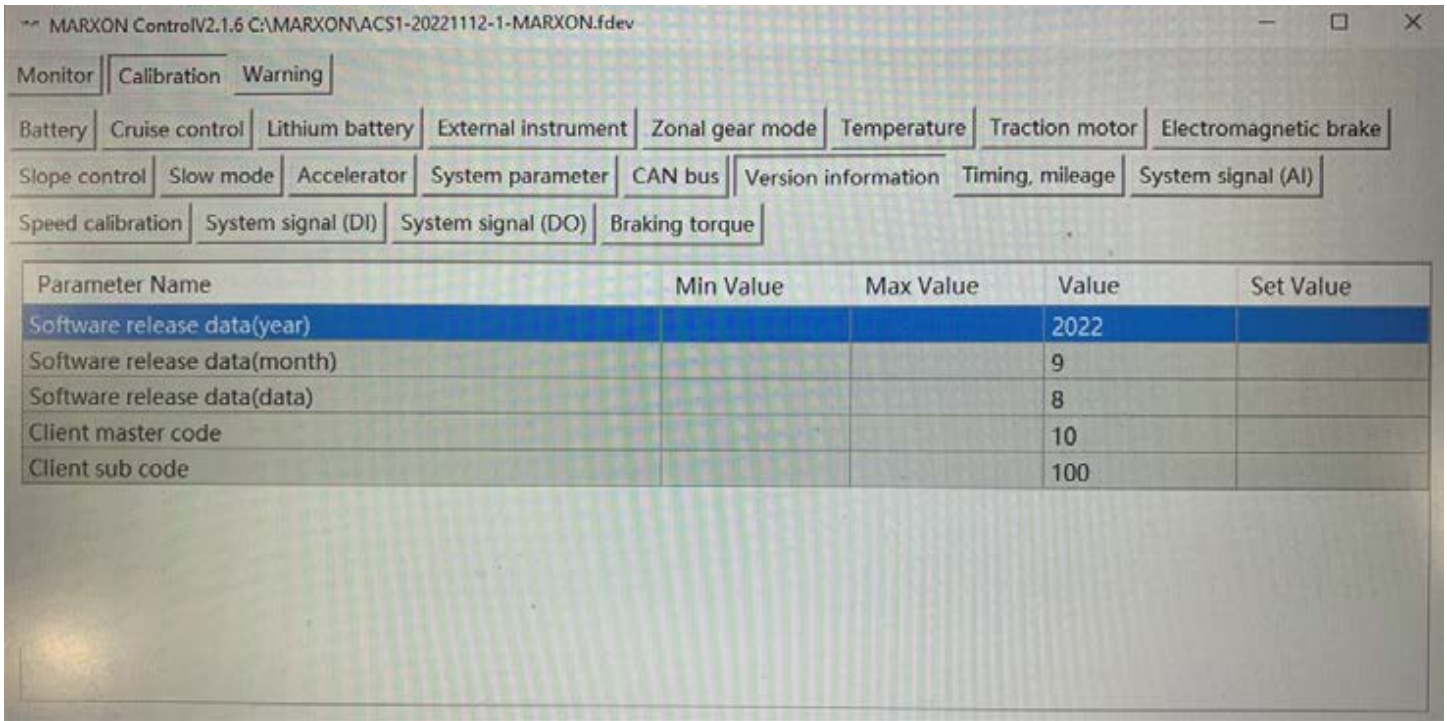

There may be very limited cases of MCX controllers that exhibit an overcurrent fault and fall before the 9-8-2022 software release. To be able to check your controller's software version data, go under the calibration tab, then click on the tab labeled 'Version Information'. You will be able to view the software release day, month and year here.

All adjustments that we've discussed so far, need to be performed on units that have software release dates AFTER this date to be effective. If you find one that has an earlier date, the controller will need to be updated if it has the overcurrent issue.



For updating the controller, open the FjBootloader Tool from inside the MCX Software Update folder. Connect the CAN USB box to the 2-pin CAN connector located behind the seat. It is above the rear shock support bar. (You can also use the 2-pin connector that is located under the center dash cupholder, feeding the CAN signal to the SOC meter). This folder and software is available by request, via email from techsupport@starev.com

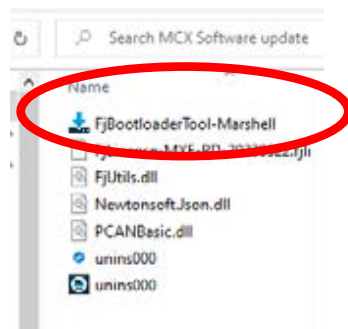

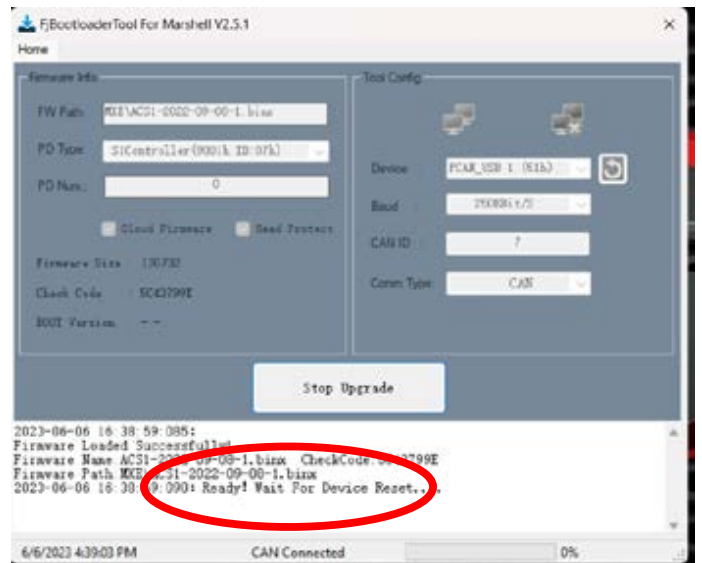
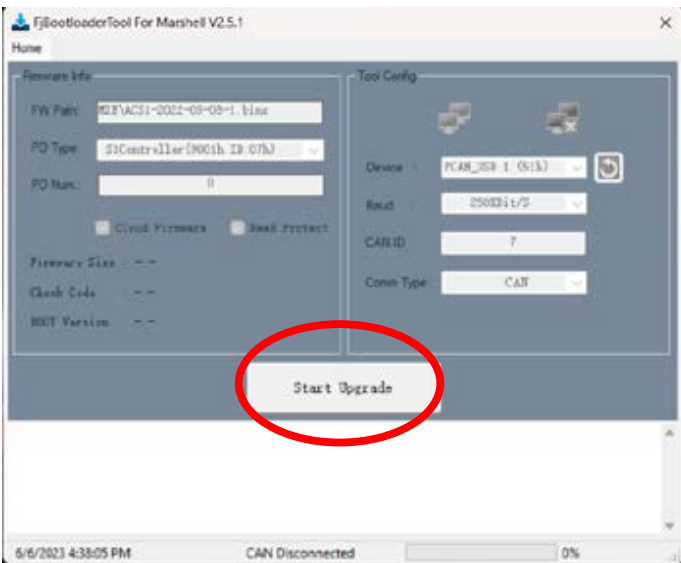
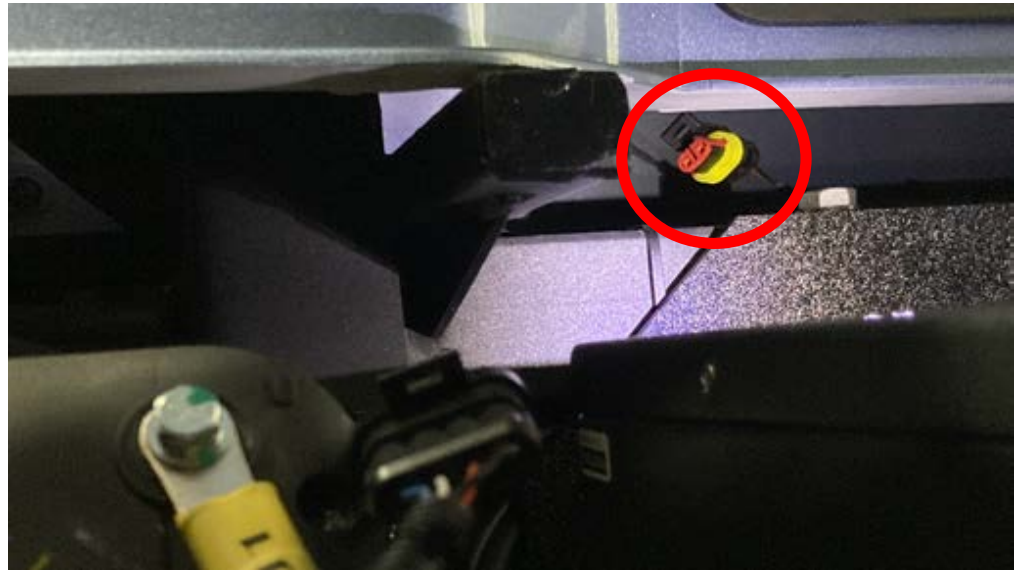

In the Bootloader software, you will arrive at the open screen. All information will be auto populated in this screen, so no changes will need to be made here. Click the 'Start Upgrade' button. The computer will download the firmware update from the web, so you must have wi-fi available for the update to download. Once the update is downloaded to the computer, you will see the reset prompt saying 'Ready! Wait For Device Reset.....' When you see this prompt, cycle the key.

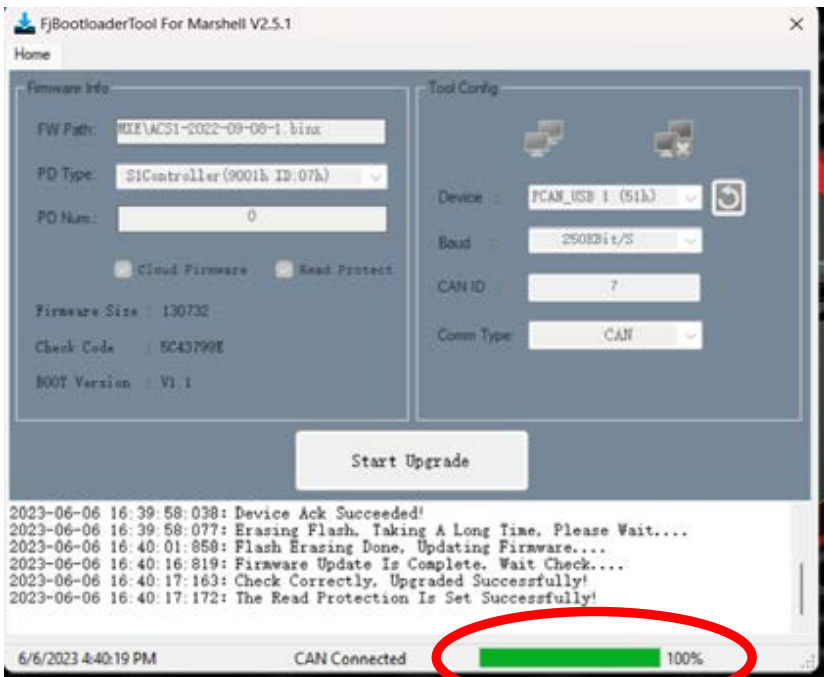

Once you have cycled the key, the computer will now begin to erase the old firmware and write the new version into the controller. You will see a progress bar at the bottom of the screen.

When the update has reached 100%, you are ready to cycle the key again. You can close the bootloader software, and re-open the Marxon software again. You will now see, at the bottom of the Marxon window 'parameter value exceeds the limit'. Cycle the key, and you will see this message go away. With the Marxon software, you can now verify the firmware version is updated to

9-8-2022, and that motor deceleration coefficient (%) is set to 10%, and braking torque is set to 60%.

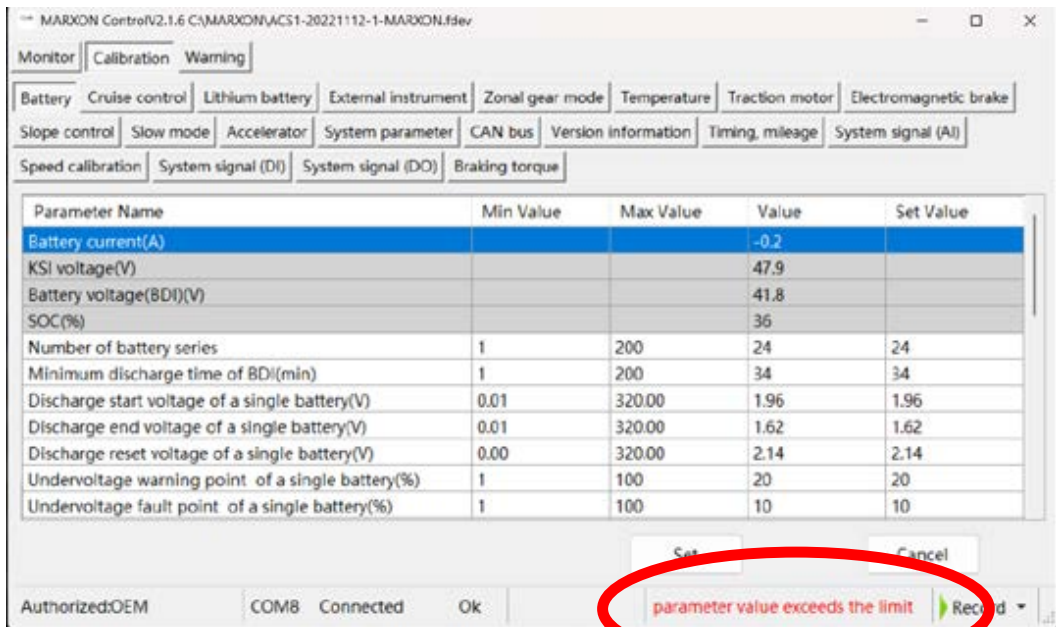

MCX Fault List

Fault Alarm Severities:

Class 1: Main circuit breaker is open, motor is prohibited from working and motor command (accelerator) fails.

Class 2: Motor prohibited from operation and motor command (accelerator) fails.

Class 3: Battery is undervoltage, limiting the maximum motor speed.

Class 5: Limit maximum output torque of the motor.

Class 6: Limit maximum motor speed.

Class 15: Power output port overcurrent fault, faulty port output prohibited.

Class 20: Warning.

Fault Code	Fault Level	Fault Name
1	1	Battery voltage too high
2	1	Battery voltage too low
3	20	Accelerator startup wrong
4	20	Maintenance time reached
5	1	Flash memory error
6	1	Bus voltage too low
7	20	Bus voltage too high
8	1	Drive motor overcurrent
11	1	The main contactor faulty
12	3	Battery capacity low
13	5	Drive motor temperature too high
15	1	Drive motor current offset
17	1	The main contactor coil overcurrent
20	5	Controller temperature too high
27	1	Controller current over threshold
37	1	The 5V output of the controller is too low
38	1	The 12V output of the controller is too low
39	2	Motor Stall
40	15	Drive 1 output over current
41	15	Drive 2 output over current
42	15	Drive 3 output over current
43	15	Drive 4 output over current
44	15	Drive 5 output over current
45	15	Drive 6 output over current
46	15	Drive 7 output over current
47	2	Solenoid brake control coil open fault

Fault Code	Fault Level	Fault Name
48	6	Mechanical failure of electromagnetic brake
49	1	Battery charger connected
61	2	Drive motor temperature too high
62	2	The direction switch is activated simultaneously
63	20	The interlock switch not activated
64	20	Wrong start sequence
66	2	Controller temperature too high
71	2	Controller temperature sensor faulty
74	1	Drive motor encoder failure
83	1	Flash no parameters
84	1	Flash memory parameter overrun
85	20	Wrong starting sequence
87	1	The system parameters do not match the firmware version
88	1	The system parameters do not match the firmware type
89	1	The system parameters do not match the firmware product number
91	6	Steering sensor failure
92	2	Pedal accelerator error
95	2	The motor temperatures sensor short circuit
97	2	The motor temperature sensor open circuit
98	1	Bus capacitor precharge failure
100	2	The external meter communication is faulty
101	6	The CAN bus communication is faulty

Curtis Controllers



Description:

The Star Sirius vehicles use either the Curtis 1232SE, or 1234SE controller. The 1232 is used for the 2 and 2+2, and the 1234 is used for the 4 and 4+2 vehicles. The 1232 is a 350amp unit, while the 1234 is a 450amp model. Both units have a U, V and W terminals for running AC electric drive motors, along with battery positive and negative connections. Both units also have a 35 pin connector. This connector is not water sealed, so inspection for water and/or corrosion is recommended if random intermittent problems can't be otherwise explained. These controllers can display fault codes via their exterior LED indicator lights, or through the Curtis 1313-4331 handheld programmer. (Star Part Number: 2PR002)

Table of Contents

Plotting Data Signals	177
Cloning a .cpf file	181
Emailing a .cpf file	188
Testing HPD/Sequencing Fault	190
Supervisor Fault	193
Testing Welded Contactor	194
Adjusting Slip Gain	197
Curtis Fault List	199

Plotting Data Signals



There are times when you may want to chart an input or output signal from the controller, over a period of time. The Curtis handheld programmer has the capability to do this, to a basic extent.

The reason we say basic here, is because of the refresh rate. The refresh rate is the amount of time that a new sample of electrical data can be sampled and translated. The refresh rate on the Curtis is approximately 500 milliseconds. The reason this falls short, is because a controller can record a fault in as little as 100 milliseconds. So an input signal can trigger a fault so quickly that the handheld can't even "see" it. But plotting of a signal can be very handy, if a fault arises and lasts long enough to chart it.

To begin, we'll need to add the data we would like to plot, to the plot variable list. For example, go to Parameters, then click the Select button.



Now let's scroll down to Motor and press the right arrow. This will open up the motor menu.

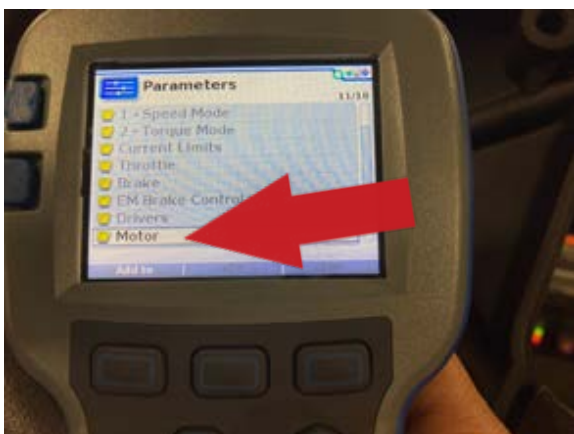

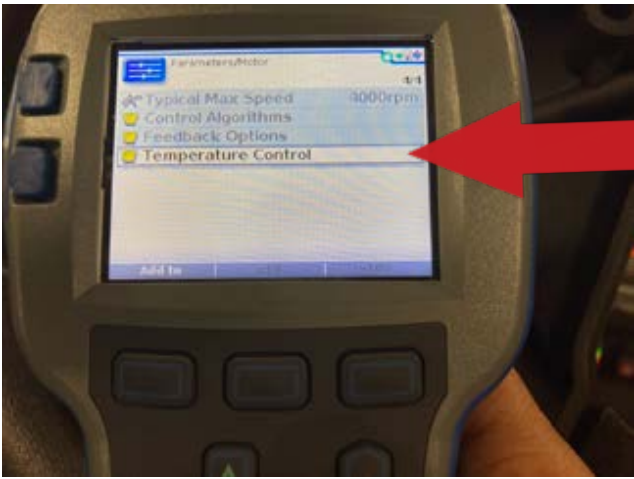

Next, scroll down to Temperature Control and press the right arrow. This will open the menu for the temperature control parameters.

At this point we can scroll to highlight Braking Thermal Cutback Enabled. Once there, click the Add To button below the left

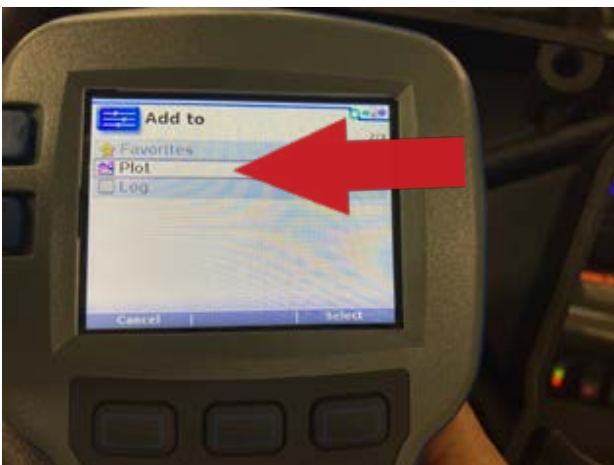
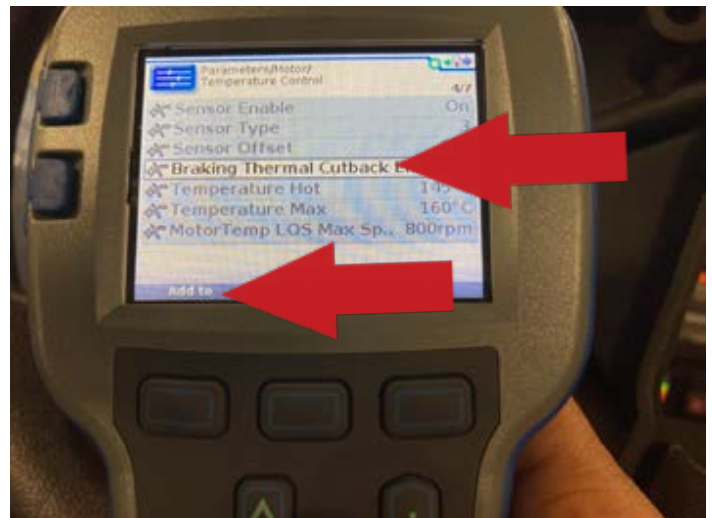

When you get to the Add To menu, highlight Plot and press the right arrow.

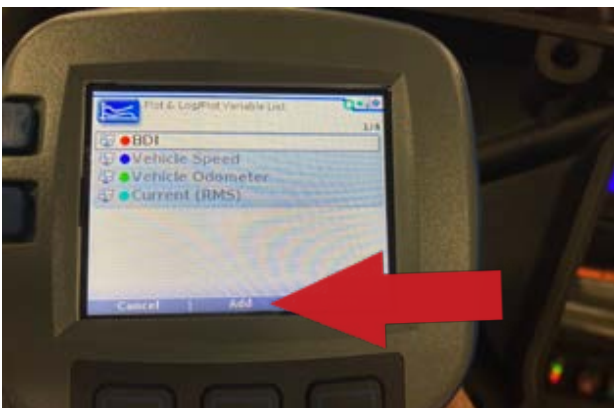

Now press the Add button below the main screen. This will add the selected parameter to the list of variables that will be plotted on the plot table.



You have now successfully added the Braking Thermal Cutback Enable parameter to the plot variable list. Click Finish to save.

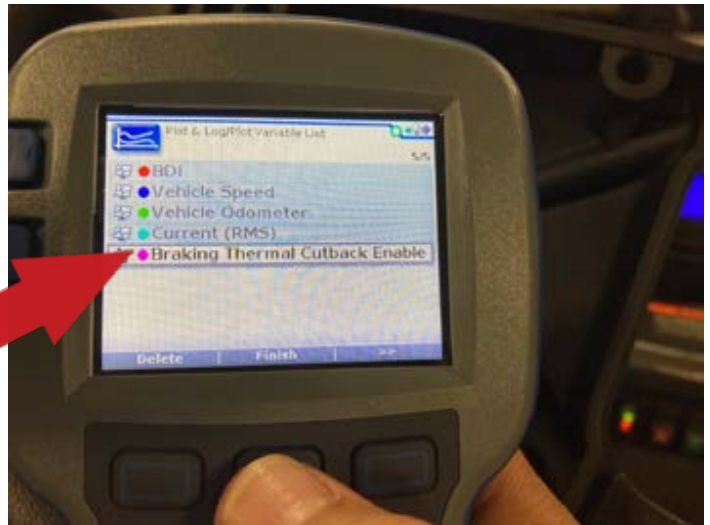

You can now back out to the main screen, and scroll down to Plot & Log. Press the Select button.

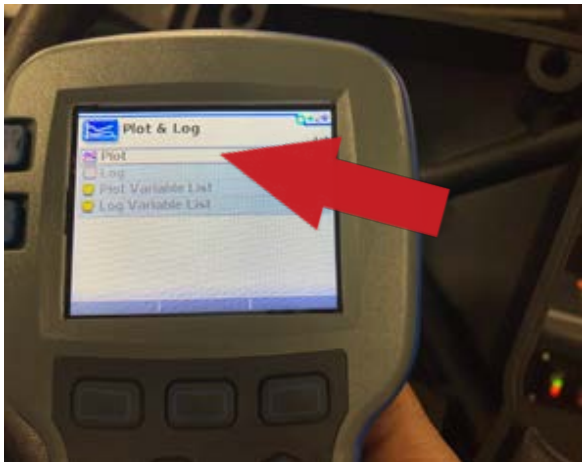

Once you've gotten here, you'll be able to press the right arrow for Plot.

Now you will be able to visually chart the data you added to the plot variable list while you are driving or performing other tests. Each of the plotted variables are color coded. To be able to know which color represents the data you're interested in, you can back up to the Plot & Log menu. Press the right arrow to enter the Plot Variable menu. Press the right arrow to enter the Plot Variable List.

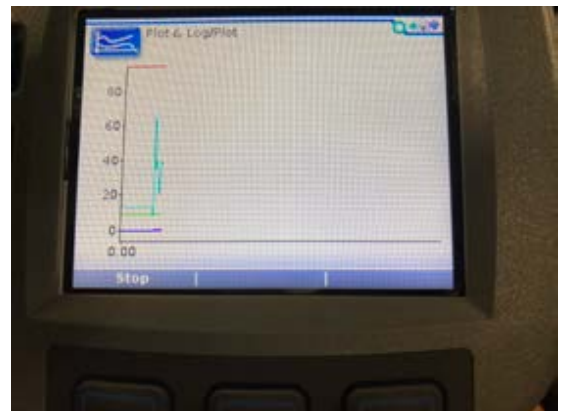



The Plot Variables List will show all the variables that will be plotted in the Plot & Log table. You would be well advised to keep this list of variables very short. The total number allowed is 4 or 5. But to make it easier to see on the plot table, it's best to only have as few as needed.

The Plot Variables List also shows the color code for each variable. The variables aren't labeled inside the table, so you will need to remember the color of the data you're interested in.



There will be a time when you will need to remove a variable from the Plot Variables List. This may be so you can add a different parameter you'd like to watch instead. It could also be that you have too many variables in your list and it's too hard to see your desired plot line.

To delete a parameter from the list, scroll down to the one you'd like to remove. Press the middle button below the screen, where it says Delete. This will remove the selected parameter from the list.



You can now back out to the main menu, and add another parameter, or proceed as normal.

Plotting parameters is a great way to test for digital inputs that you suspect are "dropping out" when driving. You can use plotting for charting motor amp draw, or any number of controller outputs.

One advantage of this technique is that you can drive and record, without having to watch the screen the whole time. With the voltages changing rapidly, on the parameters screen, it can be difficult to drive and watch the numbers at the same time.

We recommend driving with another person so they can monitor the programmer, or vice versa. If this isn't possible, the next best option is using the Plot & Log feature.

Cloning a .cpf file



Here are the steps needed, to clone a .cpf file using your Curtis handheld programmer. This can be needed when you receive or replace a controller and the parameters don't match up. This can cause drivability issues, as well as phantom fault codes, such as an EMR-REV fault.

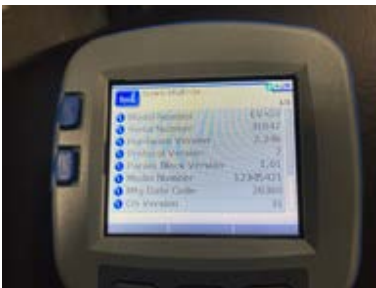

It is a good practice to take a screenshot with your phone, of the system information screen. From the home screen, select System Info. Then take a photo of the information screen. Be sure to scroll down, and include pictures until you reach the bottom of the list. These pictures will be useful if you run into problems cloning the files into the new controller.



To begin, go to Programming on the home screen and click Select.



You will be brought to a screen that will show Save a .cpf file and Restore a .cpf file. Press the right arrow, to enter the Save a .cpf menu.



The programmer will now display the file that is currently in the controller memory and you'll be copying. Press the right button below the screen, under Save .cpf.

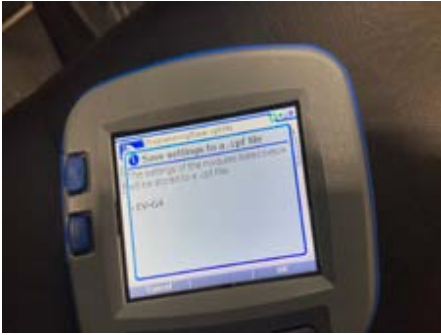

You will be asked if you'd like to save the settings to a .cpf file. Press the button under OK.

On the next screen, you will be asked where you'd like to store the .cpf file that you're about to copy. Press the right arrow, to enter the Internal menu.



Now you are inside the programmer's internal file structure, and ready to give your file a name. This will be the name that you'll look for later, when restoring/writing the file to the new controller. Press the middle button, under Save As.

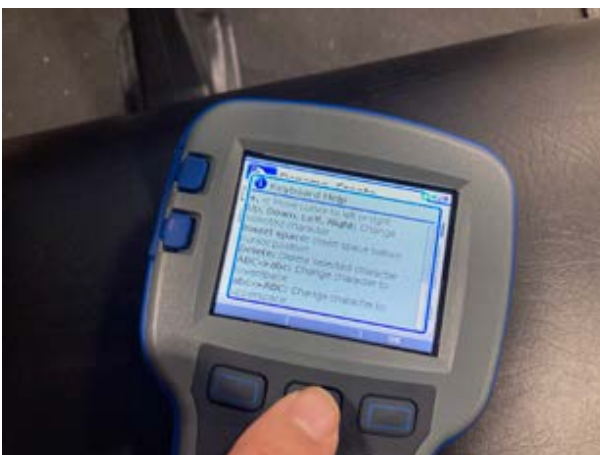
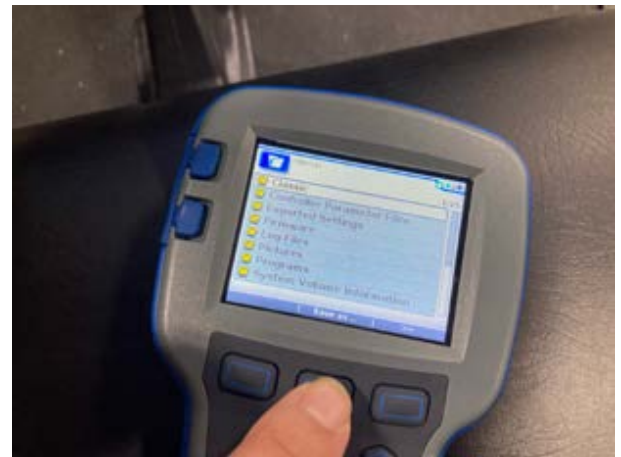

The programmer will show a helpful screen that will explain how to use the on-screen keyboard in the next step. It is very similar to sending an old school text message.



In this example, we're going to use the file name 1234. The cursor will always start on the Space key. Use the arrow keys to go up and over to 1, then press the + key. You have now just entered the number 1.

It is helpful to note that you should use a file name that is vehicle specific. As an example, Sirius 2+2. You can then start to build your own library of .cpf files, over the course of time.

Repeat the same steps for numbers 2-4.



Once you've entered your chosen file name into the input field, you can press the OK button under the middle of the screen. This will enter your file name into memory and begin saving the .cpf file.

You will see a progress bar on the screen, showing you the status of the save procedure.

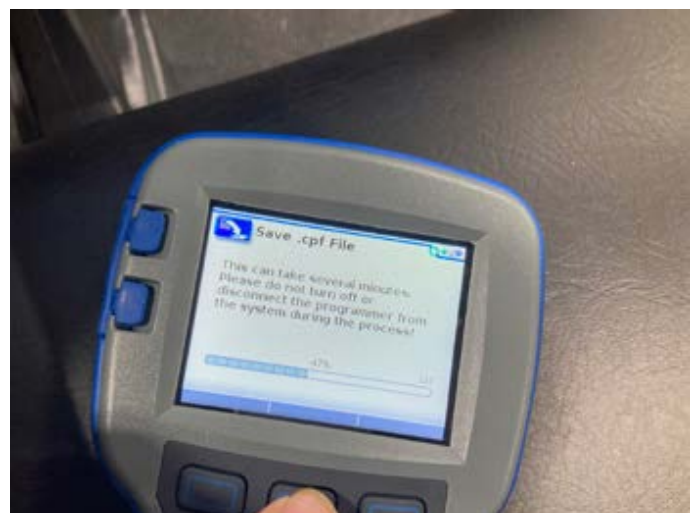

This will be followed by a Save successful notification.

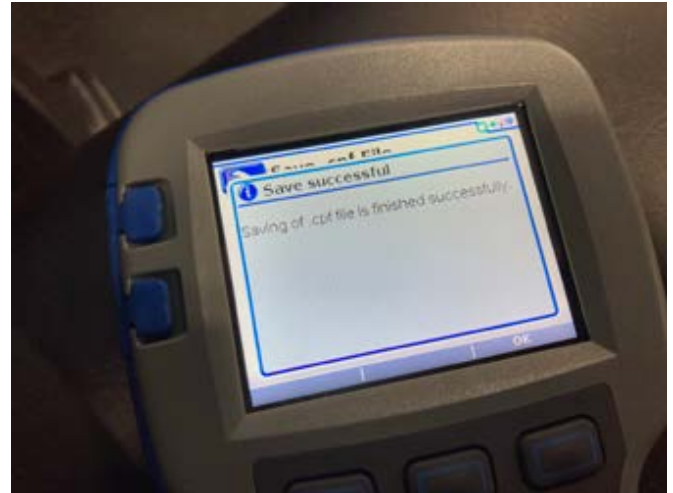

Now that we have stored the .cpf file into the internal memory of the programmer, we can now begin writing it to the new controller. Begin by connecting to the new controller and pressing the Select button when the Programming icon is highlighted on the home screen.



Scroll down on the next menu, to Restore .cpf file. Press the right arrow to enter the restore tab.

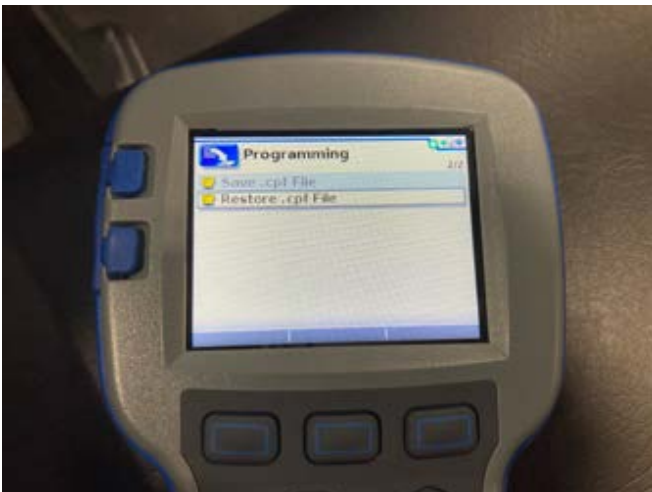

You will see a tab on the screen, telling you the current controller's information. You will just need to press the button under Restore .cpf.

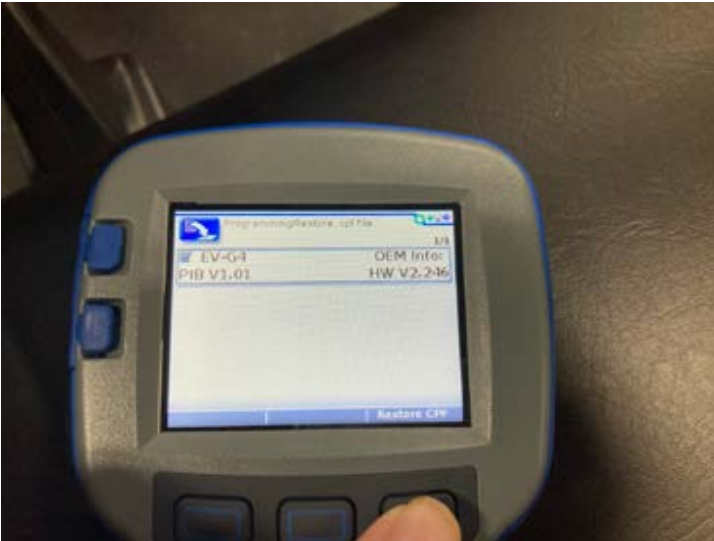

Highlight the tab that says Internal, and press the right arrow. This will take you to the internal memory of the programmer and we'll be able to look for the files we saved previously.

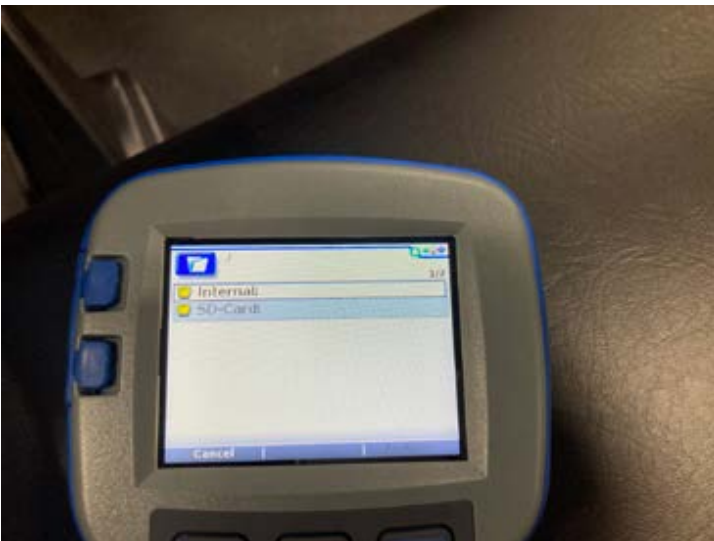

Now scroll down and locate the file that you named and saved. Here you'll see the file that we named 1234 in the menu. Now press the button below Restore.

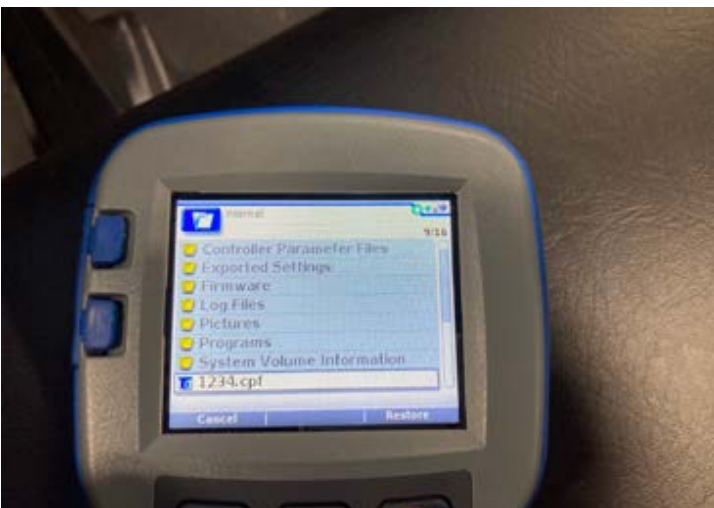

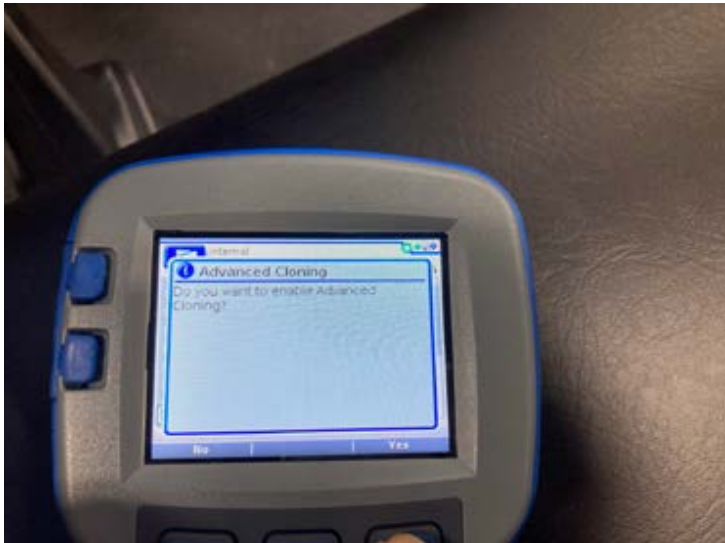

You will see a notification that asks if you'd like to use Advanced Cloning. Press the button under the Yes option.

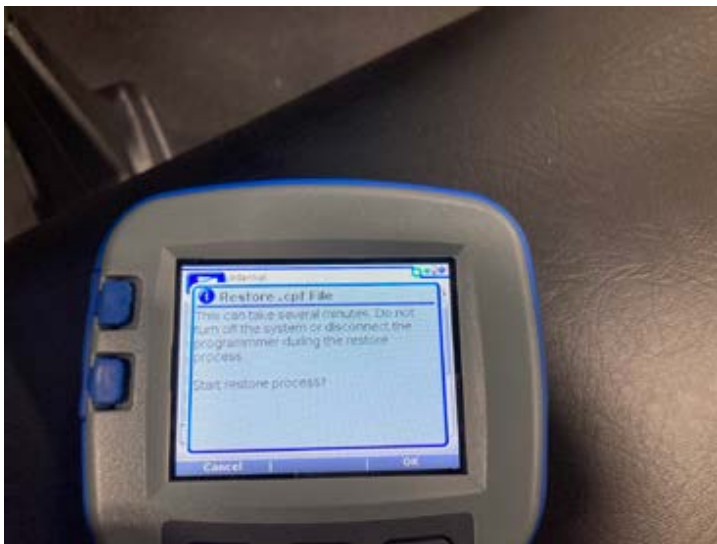

At the next screen, you will be asked if you'd like to proceed with restoring the file. Press the button under OK.

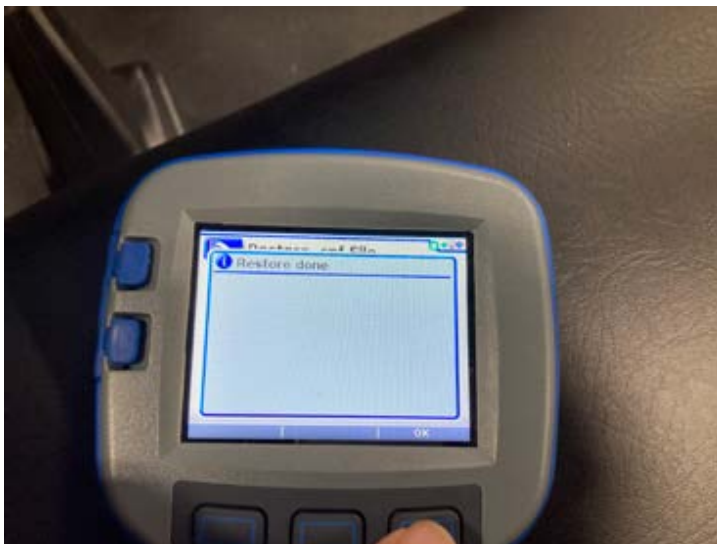

Now you'll be shown a Restore Done prompt. But this is not the last step!

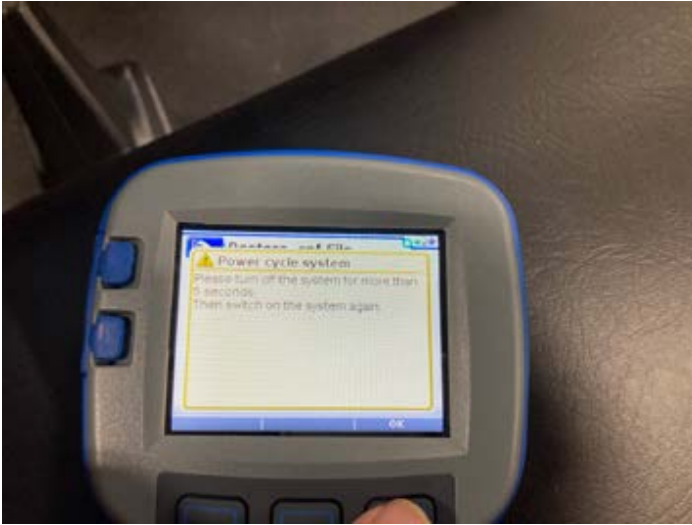

To complete the restore process, you must finish the procedure by cycling the key to the off position for at least 5 seconds. Once you've done this, you are now done. You can disconnect your handheld programmer and retest your vehicle's operation.

Emailing a .cpf File



Here are the steps needed, to email a .cpf file from your Curtis handheld programmer. It is best if you know which folder you stored the file in. This will save you time searching through several folders in later steps.



First you will need to unplug the cord from the bottom of your handheld programmer. This will reveal the mini USB port where you'll install the mini USB to USB cable. This will allow you to connect your handheld programmer to your computer.



Here are the ends of the cord you will need. The smaller one goes into your programmer, and the larger one connects to your computer. These cables are readily available from any office supply store, online, or most department stores.



As soon as you connect your handheld to your computer, it will turn on and open the file explorer. It will not open the right folder you will need. So be sure to follow the next step carefully.

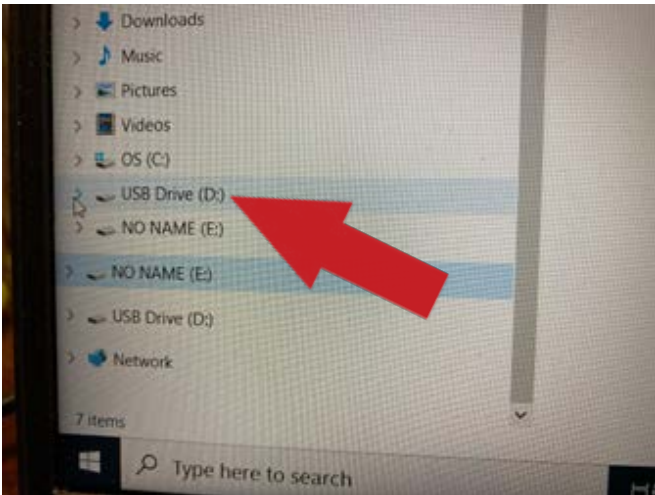

You must go to the side menu and select USB Drive. This will allow you to access the actual folder structure inside the handheld.

You will need to locate the folder where you saved the file, inside your handheld. Double click this folder, and then you will be able to find your .cpf file. You can copy this file to your computer now.

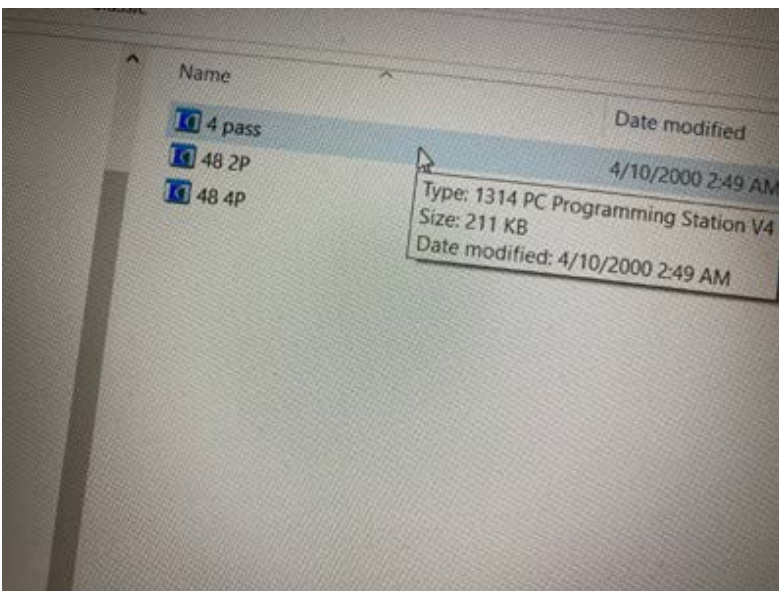
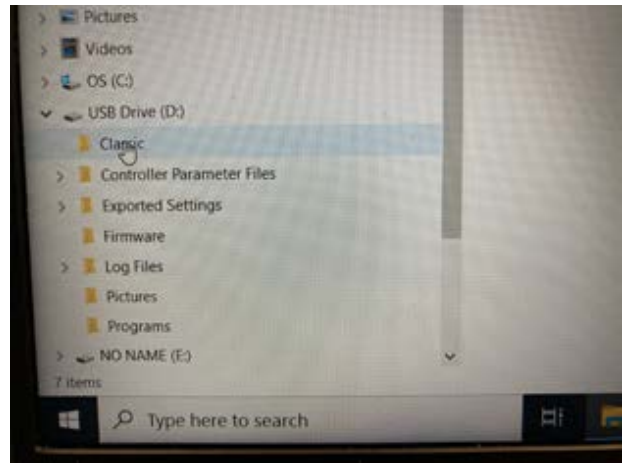

You are now ready to attach your .cpf file to your email. Open your email program and start an email as normal. Click your attach button and attach your newly saved file to your email to us.

We will be able to use your .cpf to export as an excel file, make changes if needed, and email you back the updated parameters.

The process is reversed, if we email you a .cpf file for installing into a controller. You would simply download the .cpf from our email, and then copy this file into your handheld. From there, you would restore this file to your controller.

Testing HPD/Sequencing Fault

The HPD fault stands for High Pedal Disable. This fault has the ability to disable a cart, if the fault is stored in the current faults. It is very closely tied to the sequencing fault, but there is one difference that can come into play when diagnosing the two.

The HPD fault is set when there is an improper sequence of:

- KSI (key switch input)
- Charger Interlock
- Throttle Inputs

In contrast, the sequencing fault is set when there is an improper sequence of:

- KSI (key switch input)
- Charger Interlock
- Throttle inputs
- **Direction input**

So you can see how these two faults are very closely related, with the exception of directional input.

For each of these faults, the controller is looking for certain switch inputs to take place in a controlled sequence. To test this fault setting condition, you can put your cart in neutral with the key off. Press and hold the throttle pedal down more than 25%, and then turn the key to on. This will set an HPD/Sequencing fault, because you have satisfied all the setting conditions, throttle and interlock input but no direction input.

Since this fault is not lingering, and will go away as soon as you start the vehicle properly, the fault will now move to history faults instead of current faults.

Next, we'll look at the switch inputs that are supplied to the controller in a normally operating vehicle. This will give you a baseline to compare against, so that you'll know a typical value to expect.

On the Curtis handheld programmer, you can follow along on these switch inputs by going to **Monitor>Inputs>Scroll down to Switches**

Input Switch	Capella	Normally	Classic	Normally	Sirius	Normally
Charger "Interlock"	Normally On	On	Normally On	On	Normally On	On
Switch 1	Throttle Interlock	Off=Released (On=25%+)			Throttle Interlock	Off=Released (On=25%+) Check if changes, for cart that solenoid clicks but won't move
Switch 2	Thermocouple	Off=Good			Thermocouple	Off=Good
Switch 3	Charger Interlock-Charger port LED will Blink amber for about 45 seconds, then turn solid red, after unplugging charger. All lights will blink when app is connected.	(Off=Pressed) On=Released	Throttle Interlock	Off	Charger Interlock	(Off=Pressed) On=Released
Switch 4	Parking Brake (only on long car-interrupts throttle signal)	Off=Set (On=Released)	Low Speed	Off	Parking Brake (only on long car-interrupts throttle signal)	Off=Set (On=Released)
Switch 5			Handbrake	Off	Turtle Mode (low speed)	
Switch 6						
Switch 7	Forward Direction	Off=Released (On=Pressed)	Forward Direction	Off=Released (On=Pressed)	Forward Direction	Off=Released (On=Pressed)
Switch 8	Reverse Direction	Off=Released (On=Pressed)	Reverse Direction	Off=Released (On=Pressed)	Reverse Direction	Off=Released (On=Pressed)
Charger	Charger disables drive system only		Charger disables entire cart		Charger disables drive system only	
Solenoid	Solenoid on with key		Solenoid on with key		Solenoid on with key	

As shown above, the "Normally" column has the typical value highlighted in blue. For example, if you're working on a Sirius cart with an HPD fault, with OFF displayed in the Interlock switch input, this would indicate that the charger interlock switch signal is not being input to the controller. If the charger wall cord is not plugged in, then the interlock switch is stuck, in the receptacle. Unplug the switch, and connect it's wires using a jumper wire. If the vehicle now operates, replace the charger receptacle. The interlock switch is damaged.

With this understanding of how the conditions for an HPD/Sequencing fault cause the fault to set, we will look at the different components and what order they should be checked and ruled out.

We have found that the best order of testing is as follows:

1. Charger Interlock (typically ON, under Interlock on handheld).
2. Parking brake interlock (only applies to hydraulic brake vehicles) normally OFF.
3. Throttle interlock-Check the throttle POT voltage follows pedal movement. Volts should range from .4v released, to 4.88v fully depressed. On long carts, the parking brake will disable the throttle map calculation, but the POT volts will still change with pedal movement. Be sure to check that this value changes, with a cart where the solenoid clicks but the vehicle won't drive.
4. Key switch-typically ON.
5. Forward/Reverse Switch-see HPD chart for FWD/REV inputs on handheld. This input will play into the sequencing fault more, since it is tied to directional inputs. Typically ON, with a direction selected, but OFF with both direction inputs. So, if the switch breaks internally, connecting all terminals at once, the conflicting direction inputs will read as OFF to the controller. The vehicle will not operate this way.

You may find that a new cart has an HPD fault from the factory. But this can simply be a phantom fault, due to the production process. It would be advisable to clear the fault to see if it returns to the current faults, or only to history. Keep in mind, some faults will only set with throttle input. So you will need to press the pedal down, to initiate some faults.

Faults that will not clear, even after cycling the key off/on, indicate the conditions for the fault to be set are still being met. Once the conditions are no longer being met, the faults will not set and will move to history faults.

Supervisor Fault Testing

A Supervisor fault means that a digital signal that is normally 0V or 5V, is not reading 0V or 5V. The controller expects to only see either one voltage (low), or the other (high) and anything in between will signal an issue that needs to be corrected. This fault will be set if the voltage is between 1.2V and 4V, and can be set in as little as 100 milliseconds.

The main uses for these types of signals are the switches, ie: the forward reverse switch, or high/low switch. Knowing this, you can see how the controller wouldn't know how to determine the true position of a switch selection if an unexpected voltage were to occur.

It is recommended that the switch inputs be checked, as follows:

1. Charger interlock switch.
2. Check the brake switch on short car typically. To test this, you can unplug the 2-pin wire connector from underneath the brake pedal to test if the issue is fixed. If this resolves the issue, you will cut the yellow and red wire that leads to Pin 10 of the controller and insulate both ends.
3. Check the 12V side of the converter, if on a hydraulic brake equipped vehicle. This is for the parking brake switch. In very strange cases of dropping out at full acceleration, you might check the headlights or 12V circuit to see if it's dropping out and possibly causing the parking brake switch to show closed.
4. Check the forward/reverse switch.
5. Check the high/low switch.
6. Check the throttle interlock switch.

You can disconnect the charger receptacle interlock switch and use a jumper wire to see if it's the charger interlock leaking power. This can cause a supervisor fault.

For the other switches, you will use a digital voltmeter to check the voltage being sent to the controller. Check for voltages that are within the 1.2V-4V range. In the case of the forward/reverse switch be sure to check if voltage is being supplied to both inputs at the same time. Water intrusion, or a bad switch can cause this.

In a lot of Supervisor faults, cycling the key off/back on will allow the code to be moved into history and you can operate vehicle again. But the underlying issue will still need to be addressed, or the fault will continue to set.

You can also have an HPD/Sequencing fault together with a Supervisor fault. This will depend on which way the controller sees the voltage. For example, if the controller receives a signal from the charger interlock switch indicating "not quite off" it will not be able to indicate ON or released. This will satisfy the conditions to meet both HPD/Sequencing AND Supervisor fault at the same time. **Whenever you have a condition where both faults are stored at the same time, diagnose the Supervisor fault first, followed by the HPD/Sequencing fault.**

Contactor Testing

Your Star vehicle may not operate, and store a “Main Contactor Welded” fault. If this happens, you will need to know how to check if the contactor is truly welded or not. First, you may need to get the vehicle to move to where it can be diagnosed. In order to do this we can go into the controller and disable the contactor weld check.



With your Curtis programmer, connect to the vehicle and press Select with the Parameters icon highlighted.



Next, scroll down to the Drivers tab and press the right arrow. This will access the menu for all the controller drivers.

You will see Main Contactor at the top of the screen. Press the right arrow button to enter the main contactor menu.



Scroll down to the Weld Check Enable tab, and use the + (plus) button to disable the weld check. This is only meant to be a temporary disabling of the check. You must turn this setting back on after you're done repairing the vehicle.

This is the only way to stop the controller from looking at the weld check, to allow the vehicle to be moved to the service bay. If the vehicle is able to move now, you are also checking that the other components in the drive system are capable of driving.



To determine if the contactor is truly welded, you will need to perform a voltage drop test on both sides of the contactor circuit. The voltage drop test will show if the contactor circuit is connected, under a load.

First, check for presence of power on the "hot" side of the load end of the contactor. These are the larger posts on the contactor. Use DC volts on your meter, for these tests. Connect your black lead to battery negative, for these tests.



Repeat the same test for the other leg of the same circuit, the other large post.



Now that we know that power is available to the main load side of the contactor, we can check the voltage drop across the contactor itself. If the contactor is pulled closed, you will see zero, or near-zero volts. This means that there is a good connection across the main load circuit.

In the reference photos, we're activating the contactor on purpose, to demonstrate the voltage drop test. But if you see this reading when the contactor is NOT supposed to be activated, then this is what is causing the Main Contactor Welded fault.



We still need to do one more test. We need to see if there is a closed circuit on the control side of the contactor. Here, we're using the control side to activate the contactor. As shown, you'll see near battery voltage when the control circuit is doing work.

If this is NOT being activated, you should see zero volts across this leg. When the Main Contactor Welded fault is present, the controller is seeing the main load side of the contactor closed, when it is not activating the control side. But the control side must be tested to see if there is a short, causing

it to falsely pull the contactor in. If the key switch is turned off, you should see near-battery voltage across these terminals. This is because the control side is not being activated while the key is off.

If the control side is zero volts, and the main side is zero volts, with the vehicle turned on, this means the contactor is welded. There are times when you can "unstuck" the load side, by tapping on the contactor with a rubber mallet. If this works to unstick it, this is only a temporary fix and it will most likely get stuck again. Replace the contactor.

Be sure to enable the Contactor Weld Check if you disabled it in the start of this testing guide.

Slip Gain Adjustment

There are a few performance issues that can stem from an improper slip gain adjustment. To be able to talk about slip gain, we'll need to look at how an encoder works. The encoder is responsible for sending two signals to the controller. When compared against each other, these signals tell the controller both speed and direction information.

These encoder signals are induced in the encoder magnet by a small reluctor wheel, made of many small vanes. The signal travels to the controller, where the signal is interpreted and used to calculate the speed and direction.

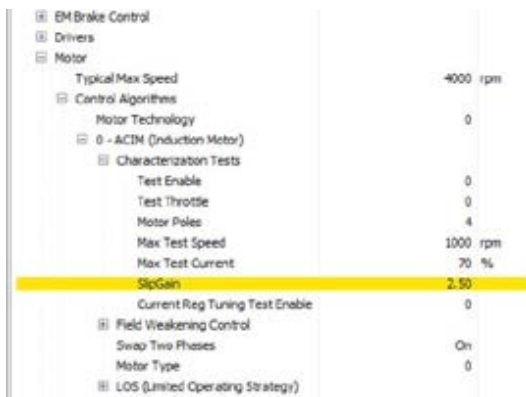

When Star carts leave the factory, they are set with a middle-of-the-road slip gain setting, that has been found to be a good balance between speed and acceleration. When you access the Curtis controller, via the Curtis handheld programmer, you can go to **Parameters>Motor>Control Algorithms>ACIM>Characterization Tests>Slip Gain** to read the current setting.

Typically, you will find it set at 2.3. But this may not be the perfect setting for your specific vehicle. This is because of variations in manufacturing of the vanes in the reluctor wheel, etc. But there are some times when this value needs to be fine tuned.



Issues you may experience when the slip gain needs adjustment:

- Surging feeling when traveling uphill
- Slight to severe fluttering feeling when going up or down hill.

2P Sirius	2.3 Slip Gain @ start
Only Audible Fluttering	1.15
Starts to be felt	1.10
Very bad uphill	1.05

After extensive testing, we have found that the Star Sirius vehicles can operate with a variety of slip gain values. But in this chart, you'll see that the most noticeable effects will be experienced if the setting is too low. You'll also notice that slip gain numbers make a drastic difference with only small changes. So a little goes a long way. Typically, we have seen carts needing just a little more than the stock setting. For Sirius', 2.3-2.5 is usually suitable. This value can be adjusted while driving, and retested immediately without resetting the key switch.



When adjusting slip gain, there are some factors that may need to be considered. These factors can combine to change the perfect slip gain setting for each vehicle.

These important factors are:

- Weight of the cargo and/or occupants in the vehicle.
- Environment where the vehicle is used.

What this means, is that the slip gain can be adjusted to fit each customer and their vehicle individually. So if the customer usually travels in a hilly area, with several passengers, then the ideal setting for their cart will be different than a cart that usually has only a driver on flat ground. This is an adjustment that needs to be configured on an as-needed basis.



Curtis Fault List

Code	Programmer Display Effect of Fault	Possible Cause	Set/Clear Conditions
12	Controller Overcurrent <i>Shutdown Motor; Shutdown Main Contactor; Shutdown EM Brake; Shutdown Throttle; Full Brake</i>	<ol style="list-style-type: none"> External short of phase U, V or W motor connections. Motor parameters are mis-tuned. Controller defective. Speed encoder noise problems. 	<p>Set: Phase current exceeded the current measurement limit.</p> <p>Clear: Cycle KSI.</p>
13	Current Sensor Fault <i>Shutdown Motor; Shutdown Main Contactor; Shutdown EM Brake; Shutdown Throttle; Full Brake</i>	<ol style="list-style-type: none"> Leakage to vehicle frame from phase U, V or W (short in motor stator). Controller defective. 	<p>Set: Controller current sensors have invalid offset reading.</p> <p>Clear: Cycle KSI.</p>
14	Precharge Failed <i>Shutdown Motor; Shutdown Main Contactor; Shutdown EM Brake; Shutdown Throttle; Full Brake</i>	<ol style="list-style-type: none"> See monitor menu>Battery: Capacitor Voltage External load on capacitor bank (B+ connection terminal) that prevents the capacitor bank from charging. 	<p>Set: Precharge failed to charge the capacitor bank to the KSI voltage.</p> <p>Clear: Cycle Interlock input or use the VCL function <i>Enable_precharge ()</i>.</p>
15	Controller Severe Undertemp <i>Shutdown Motor; Shutdown Main Contactor; Shutdown EM Brake; Shutdown Throttle; Full Brake</i>	<ol style="list-style-type: none"> See Monitor menu>Controller: Temperature. Controller is operating in an extreme environment. 	<p>Set: Heatsink temperature below -40°C.</p> <p>Clear: Bring heatsink temperature above -40°C and cycle interlock or KSI.</p>
16	Controller Severe Overtemp <i>Shutdown Motor; Shutdown Main Contactor; Shutdown EM Brake; Shutdown Throttle; Full Brake</i>	<ol style="list-style-type: none"> See Monitor menu>Controller: Temperature Controller is operating in an extreme environment. Excessive load on the vehicle. 	<p>Set: Heatsink temperature above +95°C.</p> <p>Clear: Bring heatsink temperature below +95°C.</p>

Code	Programmer Display Effect of Fault	Possible Cause	Set/Clear Conditions
17	Severe B+ Undervoltage <i>Reduced drive torque</i>	<ol style="list-style-type: none"> 1. Battery menu parameters are misadjusted. 2. Non-controller system drain on battery. 3. Battery resistance too high. 4. Battery disconnected while driving. 5. See Monitor menu>Battery: Capacitor Voltage. 6. Blown B+ fuse or main contactor did not close. 	<p>Set: Capacitor bank voltage dropped below the Severe Undervoltage limit with FET bridge enabled.</p> <p>Clear: Bring capacitor voltage above Severe Undervoltage limit.</p>
17	Severe KSI Undervoltage <i>If below brownout voltage, motor current is switched off and reset may occur.</i>	<ol style="list-style-type: none"> 1. See Monitor menu>Battery: Keyswitch Voltage. 2. Non-controller system drain on low power circuit voltage. 3. Resistance in low power circuit too high. 4. Low power circuit power source disconnected while driving. 5. Blown fuse 	<p>Set: KSI voltage dropped below 8.4V (Brownout occurs at 8.0V.)</p> <p>Clear: Bring KSI voltage above 8.4V.</p>
18	Severe B+ Overvoltage <i>Shutdown Motor; Shutdown Main Contactor; Shutdown EM Brake; Shutdown Throttle; Full Brake</i>	<ol style="list-style-type: none"> 1. See Monitor menu>Battery: Capacitor Voltage. 2. Battery menu parameters are misadjusted. 3. Battery resistance too high for given regen current. 4. Battery disconnected while regen braking. 	<p>Set: Capacitor bank voltage exceeded the Severe Overvoltage limit with FET bridge enabled.</p> <p>Clear: Bring capacitor voltage below Severe Overvoltage limit and then cycle KSI input.</p>
22	Controller Overtemp Cutback <i>Reduced drive and brake torque</i>	<ol style="list-style-type: none"> 1. See Monitor menu>Controller: Temperature. 2. Controller is performance-limited at this temperature. 3. Controller is operating in an extreme environment. 4. Excessive load on vehicle. 5. Improper mounting of controller. 	<p>Set: Heatsink temperature exceeded 85°C.</p> <p>Clear: Bring heatsink temperature below 85°C.</p>

Code	Programmer Display Effect of Fault	Possible Cause	Set/Clear Conditions
23	B+ Undervoltage Cutback <i>Reduced drive torque</i>	<ol style="list-style-type: none"> 1. Normal operation. Fault shows that the batteries need recharging. Controller is performance-limited at this temperature. 2. Battery parameters are mis adjusted. 3. Non-controller system drain on battery. 4. Battery resistance too high. 5. Battery disconnected while driving. 6. See Monitor menu>Battery: Capacitor Voltage. 7. Blown B+ fuse or main contactor did not close. 	<p>Set: Capacitor bank voltage dropped below the Undervoltage limit with the FET bridge enabled.</p> <p>Clear: Bring capacitor voltage above the Undervoltage limit.</p>
24	B+ Overvoltage Cutback <i>Reduced brake torque. Note: This fault is declared only when the controller is running in regen.</i>	<ol style="list-style-type: none"> 1. Normal operation. Fault shows that regen braking currents elevated the battery voltage during regen braking. Controller is performance-limited at this voltage. 2. Battery parameters are mis adjusted. 3. Battery resistance too high for given regen current. 4. Battery disconnected while regen braking. 5. See Monitor menu>Battery: Capacitor Voltage. 	<p>Set: Capacitor bank voltage exceeded the Overvoltage limit with the FET bridge enabled.</p> <p>Clear: Bring capacitor voltage below the Overvoltage limit.</p>
25	+5V Supply Failure <i>None, unless a fault action is programmed into the VCL.</i>	<ol style="list-style-type: none"> 1. External load impedance on +5V supply (pin 26) is too low. 2. See Monitor menu>Outputs: 5 Volts and Ext Supply Current. 	<p>Set: +5V supply (pin 26) outside the +5V±10% range.</p> <p>Clear: Bring voltage within range.</p>
26	Digital Out 6 Open/ Short <i>Digital Output 6 driver will not turn on.</i>	<ol style="list-style-type: none"> 1. External load impedance on Digital Output 6 driver (pin19) is too low. 	<p>Set: Digital Output 6 (pin 19) current exceeded 15 mA.</p> <p>Clear: Remedy the overcurrent cause and use the VCL function <code>Set_DigOut()</code> to turn the driver on again.</p>

Code	Programmer Display Effect of Fault	Possible Cause	Set/Clear Conditions
27	Digital Out 7 Open/ Short <i>Digital Output 7 driver will not turn on.</i>	1. External load impedance on Digital Output 7 (pin 20) is too low.	Set: Digital Output 7 (pin 20) current exceeded 15mA. Clear: Remedy the overcurrent cause and use VCL function Set_DigOut() to turn the driver on again.
28	Motor Temp Hot Cutback <i>Reduced drive torque.</i>	1. Motor temperature is at or above the programmed Temperature Hot setting and the current is being cut back. 2. Motor Temperature Control Menu parameters are mistuned. 3. See Monitor menu>Motor: Temperature and>Inputs: Analog 2. 4. If the application doesn't use a motor thermistor, Temp Compensation and Temp Cutback should be programmed OFF.	Set: Motor temperature is at or above the Temperature Hot parameter setting. Clear: Bring the motor temperature within range.
29	Motor Temp Sensor Fault <i>MaxSpeed reduced (LOS, Limited Operating Strategy), and motor temperature cutback disabled.</i>	1. Motor thermistor is not connected properly. 2. If the application doesn't use a motor thermistor, Motor Temp Sensor Enable should be programmed OFF. 3. See Monitor menu>Motor: Temperature and>Inputs: Analog 2.	Set: Motor thermistor input (pin 8) is at the voltage rail (0 or 10V). Clear: Bring the motor thermistor input voltage within range.
31	Coil 1 Driver Open/ Short <i>Shutdown Driver 1</i>	1. Open or short on driver load. 2. Dirty connector pins. 3. Bad crimps or faulty wiring.	Set: Driver 1 (pin 6) is either open or shorted. This fault can be set only when Main Enable=OFF. Clear: Correct open or short, and cycle driver.

Code	Programmer Display Effect of Fault	Possible Cause	Set/Clear Conditions
31	Main open or short <i>Shutdown Motor; Shutdown Main Contactor; Shutdown EM Brake; Shutdown Throttle; Full Brake</i>	<ol style="list-style-type: none"> 1. Open or short on driver load. 2. Dirty connector pins. 3. Bad crimps or faulty wiring. 	<p>Set: Main contactor driver (pin 6) is either open or shorted. This fault can be set only when Main Enable=ON.</p> <p>Clear: Correct open or short and cycle driver.</p>
32	Coil 2 Driver Open/Short <i>Shutdown Driver 2</i>	<ol style="list-style-type: none"> 1. Open or short on driver load. 2. Dirty connector pins. 3. Bad crimps or faulty wiring. 	<p>Set: Driver 2 (pin 5) is either open or shorted. This fault can be set only when EM Brake Type=0.</p> <p>Clear: Correct open or short and cycle driver.</p>
32	EM Brake Open/Short <i>Shutdown EM Brake; Shutdown Throttle; FullBrake.</i>	<ol style="list-style-type: none"> 1. Open or short on driver load. 2. Dirty connector pins. 3. Bad crimps or faulty wiring. 	<p>Set: Electromagnetic brake driver (pin 5) is either open or shorted. This fault can be set only when EM Brake Type>0.</p> <p>Clear: Correct open short and cycle driver.</p>
33	Coil 3 Driver Open/Short <i>Shutdown Driver 3</i>	<ol style="list-style-type: none"> 1. Open or short on driver load. 2. Dirty connector pins. 3. Bad crimps or faulty wiring. 	<p>Set: Driver 3 (pin 4) is either open or shorted.</p> <p>Clear: Correct open or short and cycle driver.</p>
34	Coil 4 Driver Open/Short <i>Shutdown Driver 4</i>	<ol style="list-style-type: none"> 1. Open or short on driver load. 2. Dirty connector pins. 3. Bad crimps or faulty wiring. 	<p>Set: Driver 4 (pin 3) is either open or shorted.</p> <p>Clear: Correct open or short and cycle driver.</p>
35	PD Open/Short <i>Shutdown PD</i>	<ol style="list-style-type: none"> 1. Open or short on driver load. 2. Dirty connector pins. 3. Bad crimps or faulty wiring. 	<p>Set: Proportional driver (pin 2) is either open or shorted.</p> <p>Clear: Correct open or short, and cycle driver.</p>
36	Encoder Fault <i>Shutdown EM brake; Shutdown Throttle</i>	<ol style="list-style-type: none"> 4. Motor encoder failure. 5. Bad crimps or faulty wiring. 6. See Monitor menu>Motor: Motor RPM. 	<p>Set: Motor encoder phase failure detected.</p> <p>Clear: Cycle KSI</p>

Code	Programmer Display Effect of Fault	Possible Cause	Set/Clear Conditions
36	Sin/Cos Sensor Fault <i>Shutdown EM brake; Shutdown Throttle</i>	<ol style="list-style-type: none"> 1. Sin/cos sensor failure. 2. Bad crimps or faulty wiring. 3. See Monitor menu>Motor: Motor RPM 	<p>Set: Motor Sin/Cos sensor failure detected.</p> <p>Clear: Cycle KSI.</p>
37	Motor Open <i>Shutdown Motor; Shutdown Main Contactor; Shutdown EM Brake; Shutdown Throttle; Full Brake</i>	<ol style="list-style-type: none"> 1. Motor phase is open. 2. Bad crimps or faulty wiring. 	<p>Set: Motor phase U, V, or W detected open.</p> <p>Clear: Cycle KSI.</p>
38	Main Contactor Welded <i>Shutdown Motor; Shutdown Main Contactor; Shutdown EM Brake; Shutdown Throttle; Full Brake</i>	<ol style="list-style-type: none"> 1. Main contactor tips are welded closed. 2. Motor phase U or V is disconnected or open. 3. An alternate voltage path (such as an external precharge resistor) is providing a current to the capacitor bank (B+ connection terminal) 	<p>Set: Just prior to the main contactor closing, the capacitor bank voltage (B+ connection terminal) was loaded for a short time and the voltage did not discharge.</p> <p>Clear: Cycle KSI.</p>
39	Main Contactor Did Not Close <i>Shutdown Motor; Shutdown Main Contactor; Shutdown EM Brake; Shutdown Throttle; Full Brake</i>	<ol style="list-style-type: none"> 1. Main contactor did not close. 2. Main contactor tips are oxidized, burned or not making good contact. 3. External load on capacitor bank(B+ connection terminal) that prevents capacitor bank from charging. 4. Blown B+ fuse 	<p>Set: With the main contactor commanded close, the capacitor bank voltage (B+ connection terminal) did not charge to B+.</p> <p>Clear: Cycle KSI.</p>
41	Throttle Wiper High <i>Shutdown Throttle</i>	<ol style="list-style-type: none"> 1. See Monitor menu>Inputs: Throttle Pot. 2. Throttle pot wiper voltage too high. 	<p>Set: Throttle pot wiper (pin 16) voltage is lower than the high fault threshold (can be changed with the VCL function <i>Setup_Pot_Faults()</i>).</p> <p>Clear: Bring throttle pot wiper voltage above the fault threshold.</p>

Code	Programmer Display Effect of Fault	Possible Cause	Set/Clear Conditions
42	Throttle Wiper Low <i>Shutdown throttle</i>	<ol style="list-style-type: none"> 1. See Monitor menu>Inputs: Throttle Pot. 2. Throttle pot wiper voltage too low. 	<p>Set: Throttle pot wiper (pin 16) voltage is lower than the low fault threshold (can be changed with the VCL function <i>Setup_Pot_Faults()</i>).</p> <p>Clear: Bring throttle pot wiper voltage above the fault threshold.</p>
43	Pot2 Wiper High <i>FullBrake</i>	<ol style="list-style-type: none"> 1. See Monitor menu>Inputs: Pot2 Raw. 2. Pot2 wiper voltage too high. 	<p>Set: Pot2 wiper (pin 17) voltage is higher than the high fault threshold (can be changed with the VCL function <i>Setup_Pot_Faults()</i>).</p> <p>Clear: <i>Bring Pot2 wiper voltage below the fault threshold.</i></p>
44	Pot2 Wiper Low <i>FullBrake</i>	<ol style="list-style-type: none"> 1. See Monitor menu>Inputs: Pot2 Raw. 2. Pot2 wiper voltage too low. 	<p>Set: Pot2 wiper (pin 17) voltage is lower than the low fault threshold (can be changed with the VCL function <i>Setup_Pot_Faults()</i>).</p> <p>Clear: <i>Bring Pot2 wiper voltage above the fault threshold.</i></p>
45	Pot Low Overcurrent <i>Shutdown Throttle: FullBrake</i>	<ol style="list-style-type: none"> 1. See Monitor menu>Outputs: Pot Low. 2. Combined pot resistance connected to pot low is too low. 	<p>Set: Pot low (pin 18) current exceeds 10mA.</p> <p>Clear: Clear pot low overcurrent condition and cycle KSI.</p>
46	EEPROM Failure <i>Shutdown Motor; Shutdown Main Contactor; Shutdown EM Brake; Shutdown Throttle; Shutdown Interlock; ShutdownDriver1; ShutdownDriver2; ShutdownDriver3; ShutdownDriver4; ShutdownPD; Full Brake</i>	<ol style="list-style-type: none"> 1. Failure to write to EEPROM memory. This can be caused by EEPROM memory writes initiated by VCL, by the CAN bus, by adjusting parameters with the programmer or by loading new software into the controller. 	<p>Set: Controller operating system tried to write to EEPROM memory and failed.</p> <p>Clear: Download the correct software (OS) and matching parameter default settings into the controller and cycle KSI.</p>

Code	Programmer Display Effect of Fault	Possible Cause	Set/Clear Conditions
47	HPD/Sequencing Fault <i>Shutdown Throttle</i>	<ol style="list-style-type: none"> 1. KSI, interlock, direction, and throttle inputs applied in incorrect sequence. 2. Faulty wiring, crimps, or switches at KSI, interlock, direction, or throttle inputs. 3. See Monitor menu>Inputs. 	<p>Set: HPD (High Pedal Disable) or sequencing fault caused by incorrect sequence of KSI, interlock, direction, and throttle inputs.</p> <p>Clear: Reapply inputs in correct sequence.</p>
47	Emer Rev HPD <i>Shutdown Throttle;</i> <i>ShutdownEMBrake</i>	<ol style="list-style-type: none"> 1. Emergency Reverse operation has concluded, but the throttle, forward and reverse inputs, and interlock have not been returned to neutral. 	<p>Set: At the conclusion of Emergency Reverse, the fault was set because various inputs were not returned to neutral.</p> <p>Clear: If EMR_Interlock=On, clear interlock, throttle, and direction inputs. If EMR_Interlock=Off, clear the throttle and direction inputs.</p>
48	Following Error Fault <i>Shutdown Motor; Shutdown Main Contactor; Shutdown EM Brake; Shutdown Throttle; Shutdown Interlock; ShutdownDriver1; ShutdownDriver2; ShutdownDriver3; ShutdownDriver4; ShutdownPD; Full Brake</i>	<ol style="list-style-type: none"> 1. The following error limit has been exceeded for the following error time. 2. Incorrect or overly restrictive following error limit and following error time parameter settings. 3. Motor or drivetrain rotation obstruction or degradation. 	<p>Set: The following error limit has been exceeded for the following error time.</p> <p>Clear: Cycle KSI.</p>
49	Parameter Change Fault <i>ShutdownMotor; Shutdown Main Contactor; Shutdown EMBrake; Shutdown Throttle; FullBrake</i>	<ol style="list-style-type: none"> 1. This is a safety fault caused by a change in certain parameter settings so that the vehicle will not operate until KSI is cycled. For example, if a user changes the Throttle Type this fault will appear and require cycling KSI before the vehicle can operate. 	<p>Set: Adjustment of a parameter setting that requires cycling of KSI.</p> <p>Clear: Cycle KSI.</p>

Code	Programmer Display Effect of Fault	Possible Cause	Set/Clear Conditions
51-67	OEM Faults <i>(See OEM documentation)</i>	1. These faults can be defined by the OEM and are implemented in application-specific VCL code. See OEM documentation.	Set: See OEM documentation. Clear: See OEM documentation.
68	VCL Run Time Error <i>Shutdown Motor; Shutdown Main Contactor; Shutdown EM Brake; Shutdown Throttle; Shutdown Interlock; ShutdownDriver1; ShutdownDriver2; ShutdownDriver3; ShutdownDriver4; ShutdownPD; Full Brake</i>	1. VCL code encountered a runtime VCL error. 2. See Monitor menu>Controller: VCL Error Module and VCL Error. This error can then be compared to the runtime VCL module ID and error code definitions found in the specific OS system information file.	Set: Runtime VCL code error condition. Clear: Edit VCL application software to fix this error condition; flash the new compiled software and matching parameter defaults; cycle KSI.
69	External Supply Out of Range <i>None, unless a fault action is programmed in VCL.</i>	1. External load on the 5V or 12V supplies draws either too much or too little current. 2. Fault Checking Menu parameters Ext Supply Max and Ext Supply Min are mistuned. 3. See Monitor menu>Outputs: Ext Supply Current.	Set: The external supply current (combined current used by the 5V supply (pin26) and 12V supply (pin 25) is either greater than the upper current threshold or lower than the lower current threshold. The two thresholds are defined by the External Supply Max and External Supply Min parameter settings. Clear: Bring the external supply current within range.
71	OS General <i>Shutdown Motor; Shutdown Main Contactor; Shutdown EM Brake; Shutdown Throttle; Shutdown Interlock; ShutdownDriver1; ShutdownDriver2; ShutdownDriver3; ShutdownDriver4; ShutdownPD; Full Brake</i>	1. Internal Controller Fault.	Set: Internal controller fault detected. Clear: Cycle KSI.

Code	Programmer Display Effect of Fault	Possible Cause	Set/Clear Conditions
72	PDO Timeout Shutdown Throttle; CAN NMT State set to Pre-operational.	1. Time between CAN PDO messages received exceeded the PDO Timeout Period.	Set: Time between CAN PDO messages received exceeded the PDO Timeout Period. Clear: Cycle KSI or receive CAN NMT message.
73	Stall Detected <i>Shutdown EM Brake; Shutdown Throttle; Control Mode changed to LOS (Limited Operating Strategy)</i>	1. Stalled motor. 2. Motor encoder failed. 3. Bad crimps or faulty wiring. 4. Problems with power supply for the motor encoder. 5. See Monitor menu>Motor: Motor RPM.	Set: No motor encoder movement detected. Clear: Either cycle KSI or detect valid motor encoder signals while operating in LOS mode and return Throttle Command=0 and Motor RPM=0.
74	Fault on Other Traction Controller	Dual Drive Fault: See Dual Drive Manual	
75	Dual Severe Fault	Dual Drive Fault: See Dual Drive Manual.	
77	Supervisor Fault <i>Shutdown Motor; Shutdown Main Contactor; Shutdown EM Brake; Shutdown Throttle; Shutdown Interlock; ShutdownDriver1; ShutdownDriver2; ShutdownDriver3; ShutdownDriver4; ShutdownPD; Full Brake</i>	1. The Supervisor has detected a mismatch in redundant readings. 2. Internal damage to Supervisor microprocessor. 3. Switch inputs allowed to be within upper and lower thresholds for over 100 milliseconds.	Set: Mismatched redundant readings; damaged Supervisor/ illegal switch inputs. Clear: Check for noise or voltage drift in all switch inputs; check connections; cycle KSI.
78	Supervisor Incompatible <i>Shutdown Motor; Shutdown Main Contactor; Shutdown EM Brake; Shutdown Throttle; Shutdown Interlock; ShutdownDriver1; ShutdownDriver2; ShutdownDriver3; ShutdownDriver4; ShutdownPD; Full Brake</i>	1. The main OS is not compatible with the Supervisor OS.	Set: Incompatible software. Clear: Load properly matched OS code or update the Supervisor code; cycle KSI.
82	Bad Calibrations <i>Shutdown Motor; Shutdown Main Contactor; Shutdown EM Brake; Shutdown Throttle; Full Brake</i>	1. Internal Controller Fault	Set: Internal controller fault detection. Clear: Cycle KSI.
83	Driver Supply <i>Shutdown Motor; Shutdown Main Contactor; Shutdown EM Brake; Shutdown Throttle; Full Brake</i>	2. Internal controller fault in the voltage supply for the driver circuits.	Set: Internal controller fault detection. Clear: Cycle KSI.

Code	Programmer Display Effect of Fault	Possible Cause	Set/Clear Conditions
87	Motor Characterization Fault <i>Shutdown Motor; Shutdown Main Contactor; Shutdown EM Brake; Shutdown Throttle; Full Brake</i>	1. Motor characterization failed during characterization process. See Monitor menu>Controller: Motor Characterization Error for cause: 0=none. 1=encoder signal seen, but step size not determined; set Encoder Step Size manually. 2=motor temp sensor fault. 3=motor temp hot cutback fault. 4=controller overtemp cutback fault. 5=controller undertemp cutback fault. 6=undervoltage cutback fault. 7=severe overvoltage fault. 8=encoder signal not seen or one or both channels missing. 9=motor parameters out of characterization range.	Set: Motor characterization failed during the motor characterization process. Clear: Correct fault; cycle KSI.
88	Encoder Pulse Count Fault <i>Shutdown Motor; Shutdown Main Contactor; Shutdown EM Brake; Shutdown Throttle; Shutdown Interlock; ShutdownDriver1; ShutdownDriver2; ShutdownDriver3; ShutdownDriver4; ShutdownPD; Full Brake</i>	1. Encoder Steps parameter does not match the actual motor encoder.	Set: Motor lost IFO control and accelerated without throttle command. Clear: Ensure the Encoder Steps parameter matches the actual encoder; cycle KSI.
89	Motor Type Fault <i>Shutdown Motor; Shutdown Main Contactor; Shutdown EM Brake; Shutdown Throttle; Full Brake</i>	1. The Motor_Type parameter value is out of range.	Set: Motor_Type parameter is set to an illegal value. Clear: Set Motor_Type to correct value and cycle KSI.

Code	Programmer Display Effect of Fault	Possible Cause	Set/Clear Conditions
91	VCL/OS Mismatch <i>Shutdown Motor; Shutdown Main Contactor; Shutdown EM Brake; Shutdown Throttle; Shutdown Interlock; ShutdownDriver1; ShutdownDriver2; ShutdownDriver3; ShutdownDriver4; ShutdownPD; Full Brake</i>	1. The VCL software in the controller does not match the OS software in the controller.	Set: VCL and OS software do not match; when KSI cycles a check is made to verify the they match and a fault is issued when they do not. Clear: Download the correct VCL and OS software into the controller.
92	EM Brake Failed to Set <i>Shutdown EM Brake; Shutdown Throttle.</i> <i>Position Hold is engaged when Interlock=On.</i>	1. Vehicle movement	Set: After the EM Brake was commanded to set and time has elapsed to allow the brake to fully engage, vehicle movement has been sensed. Clear: Activate the throttle.
93	Encoder LOS (Limited Operating Strategy) <i>Enter LOS control mode</i>	1. Limited Operating Strategy (LOS) control mode has been activated, as a result of either an Encoder Fault (Code 36) or a Stall Detect Fault (Code 73). 2. Motor encoder failure. 3. Bad crimps or faulty wiring. 4. Vehicle is stalled.	Set: Encoder fault (Code 36) or Stall Detect Fault (Code 73) was activated, and Brake or Interlock has been applied to active LOS control mode, allowing limited motor control. Clear: Cycle KSI or if LOS mode was activated by the Stall Fault, clear by ensuring encoder senses proper operation, Motor RPM=0, and Throttle Command=0.
94	Emer Rev Timeout <i>Shutdown EM Brake; Shutdown Throttle.</i>	1. Emergency Reverse was activated and concluded because the EMR Timeout timer has expired. 2. The emergency reverse input is stuck On.	Set: Emergency Reverse was activated and ran until the EMR Timeout Timer expired. Clear: Turn the emergency reverse input Off.

Code	Programmer Display Effect of Fault	Possible Cause	Set/Clear Conditions
98	Illegal Mode Number <i>Shutdown Motor; Shutdown Main Contactor; Shutdown EM Brake; Shutdown Throttle; Full Brake</i>	<ol style="list-style-type: none"> 1. Model_Number variable contains illegal value. 2. Software and hardware do not match. 3. Controller defective. 	<p>Set: Illegal Model_Number variable; when KSI cycles, a check is made to confirm a legal Model_Number, and a fault is issued if one is not found.</p> <p>Clear: Download appropriate software for your controller model.</p>
99	Parameter Mismatch <i>Shutdown Motor; Shutdown Main Contactor; Shutdown EM Brake; Shutdown Throttle; Full Brake</i>	<ol style="list-style-type: none"> 1. Dual Motor Enable parameter is set On and Control Mode Select parameter not set to 1 (Speed Mode Express) or 2 (Speed Mode). 2. Motor Technology and Feedback Type parameters do not match. 	<p>Set: When the Dual Drive software is enabled, the controller must be set to either Speed Mode Express or Speed Mode; otherwise this fault is set. Motor Technology=0 must be paired with Feedback Type=1, and Motor Technology =1 must be paired with Feedback Type=2; otherwise this fault is set.</p> <p>Clear: Adjust parameters to appropriate values and cycle KSI.</p>

Converter

The Star Sirius vehicles feature a DC 48V-DC12V/20Amp, key switch input controlled voltage converter. The chart below shows the wire colors, along with the voltages you should expect to see on each. The yellow wire has an in-line 20 amp, automotive style blade fuse (yellow).

The converter is responsible for reducing the overall vehicle voltage down to a voltage that the 12V accessories can use. Therefore, the converter will need to be checked when the 12V accessory side of the vehicle is not working.

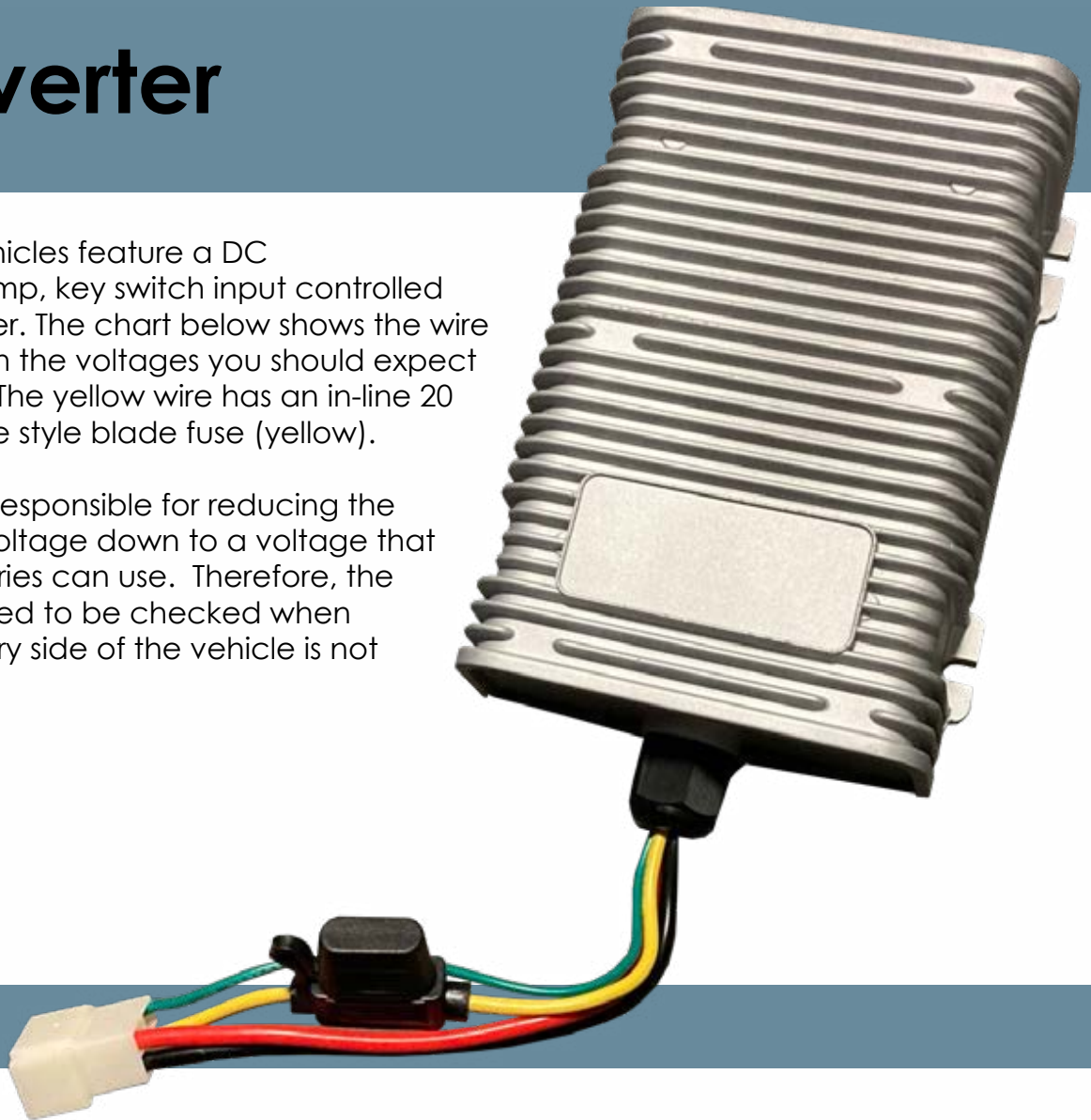

Component Wire Color	Vehicle Wire Color	Designation
Yellow	Orange	(20A Fused) Full Battery Voltage with Key Switch Input
Green	Red	Constant Full Battery Voltage
Black	Black	Ground
Red	Red	12V Output



To test a converter, you will first begin by verifying that it is receiving full battery voltage on the yellow wire with the key turned on. On the vehicle side, this wire is orange. On the component side, it is yellow. If you are not receiving voltage here, check and make sure your 20A fuse is not blown. If voltage is still not available, you will need to refer to the Sirius wiring diagram since the orange wire comes from the key switch. You will need to diagnose why the voltage isn't reaching the converter.

On the green wire, you will have constant full battery voltage. On the vehicle side, this wire will be red, and the power comes directly from the battery for this wire.

The black wire is black on the vehicle and component sides. This the ground supply for the converter. If you don't have a good ground, you will need to diagnose why the ground is faulty.

Next, is the red wire. This is red on both the vehicle and component sides, and outputs 12V to the cart. This power should be 12V on this wire, provided all the other inputs to the converter are good. This 12V power goes straight to the fuse box, to feed all the 12V accessories. It is possible that all your converter inputs are good, and 12V isn't being supplied out. If this is the case, replace the converter and retest.



Replacing the DC Converter



For replacing the DC to DC converter, you will need an impact gun, with a long #3 Phillips bit. You could also use a long #3 screwdriver.



To start this replacement, it is best that you remove the seat cushion from the vehicle. Secure the seatbelt buckles behind the lip at the top of the seatbelt compartment at the back of the seat. Raise the seat cushion and slide the hinge sections apart. This will allow you to set the seat cushion aside.

With the key turned off, you will locate the white 4-pin connector located near the bottom of the converter. There is a squeeze tab that will let the connector come loose when squeezed. Take the connector apart.

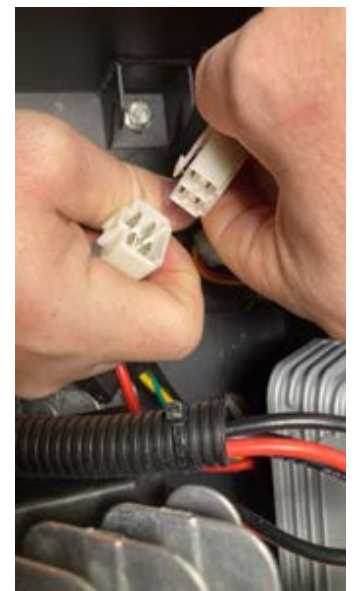



Using an impact with a #3 Phillips screwdriver bit, remove the two screws securing the inboard side of the converter. These two screws have round screw holes, so they need to come out completely. On the opposite side of the converter, the holes are slotted so they only need to be loosened and not removed fully.

On the outboard side of the converter, only loosen the two screws. These holes are slotted, so you will be able to slide the converter out from under these two screws. This is intended to aid in making installation easier.



This photo shows the slots around the screw heads. Sliding the converter inward will release it from the vehicle.



Slide the slots in the converter mounting tabs under the two mounting screws. Install the two remaining screws into the opposite side holes. This will align the holes in the opposite side with the holes below. If you tighten the screws in the slotted holes first, the round holes may not be aligned properly due to the available movement in the slots.



Tighten the inboard screws first, followed by the outboard screws. Once all screws are tight, reconnect the 4-pin converter connector to the vehicle.

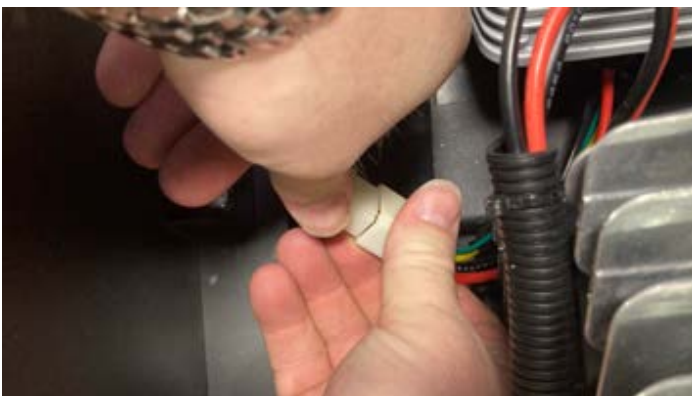

Brakes

Description:

The Sirius vehicle comes in two brake configurations, hydraulic and mechanical. The hydraulic brake system has brake components that are almost identical to an automotive brake system, except for the vacuum brake booster. All Star vehicles are equipped with a parking brake, which is cable activated. The mechanical system has a central equalizer that allows for even distribution of force to both rear wheels. There are several adjustment points on both Sirius braking systems, that can help or hinder brake and/or parking brake operation if not performed correctly.

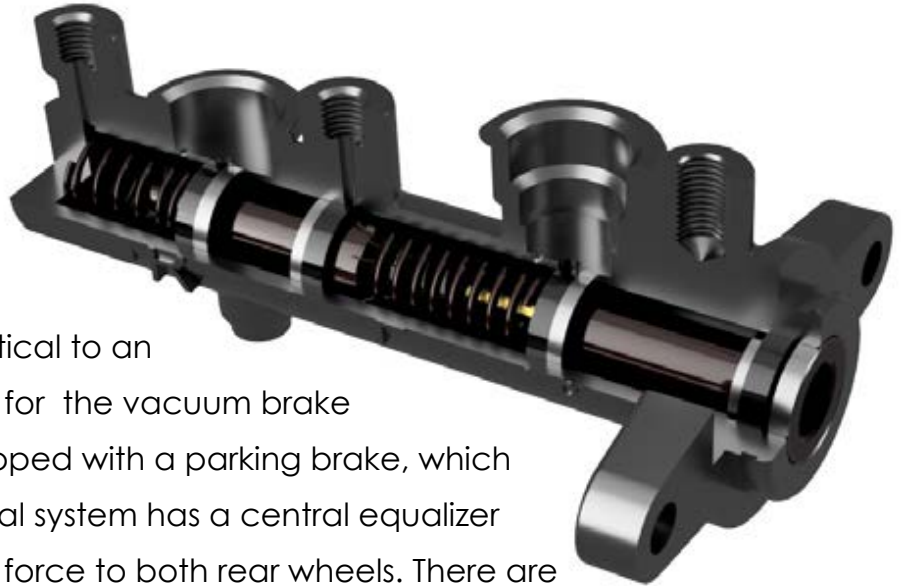

The 2 and 2+2 Sirius has a parking brake which is built into the brake pedal assembly, while the longer cars feature a separate parking brake pedal. While both parking brake systems share cables in common, they are not interchangeable and their routing through the carts are vastly different.

Table of Contents

Master Cylinder Adjustments	218
Replacing the Master Cylinder	231
Replacing Hydraulic Brake Shoes	233
Replacing Manual Brake Shoes	235
Replacing the Brake Pads	237
Replacing the Brake Caliper	239
Replacing the Front Rotor	240
Replacing the Front Brake Hose	242
Replacing the Rear Brake Hose	243
Replacing the 4P Parking Brake	245
Replacing the 4P Parking Brake Cable	248
Replacing Hydraulic Backing Plate	252
Replacing Manual Backing Plates	256

Hydraulic Brake Adjustments

Proper master cylinder pushrod adjustments are very critical in the hydraulic brake Sirius vehicle. In the diagram below, we've taken some parts out of the way, to make it easier to see the linkage components. If the wheel brakes are tight, or locking up, begin your diagnosis here, at the pushrod adjustment. As we'll discuss later, the linkage components are shielded by the mounting bracket, making it very easy to adjust the wrong adjuster, because it is out in the open.

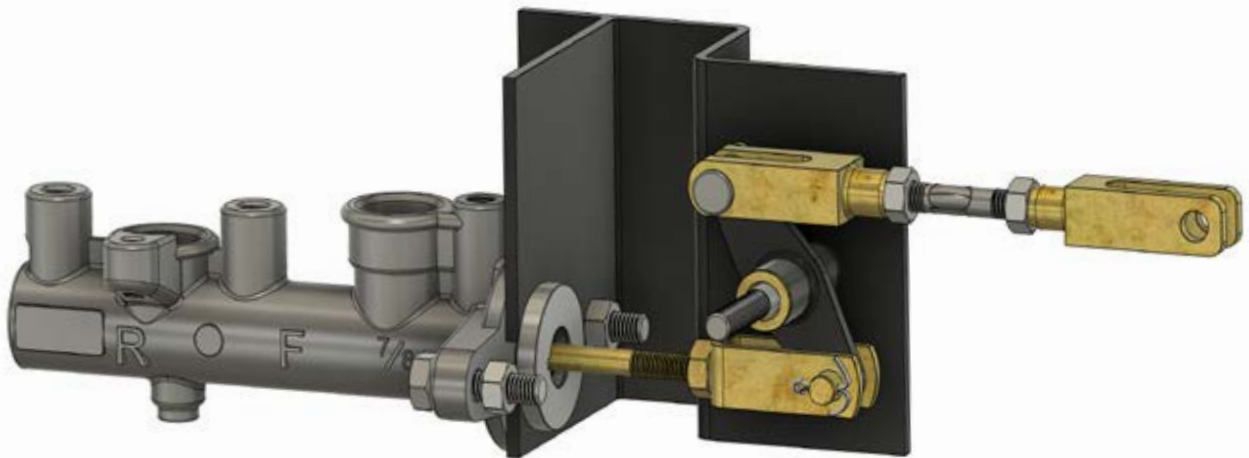

Some of the issues that stem from the brakes being out of adjustment are:

- Front brakes getting too hot, glazing the pads and causing squeaking and accelerated wear
- Front brakes staying applied
- Rear brakes staying applied and glazing the shoes, causing squeaking and accelerated wear
- Battery range being reduced due to dragging brakes, especially the Lithium-equipped units (could be front, rear, or both combined)
- No brake fluid reaching the rear brakes, especially when bleeding the brakes
- Brakes heating up too much, causing them to expand and lock down the affected wheel(s), typically causing the vehicle to slow down or even wstop moving
- Reduction in battery range due to higher amp draw

As previously mentioned, the master cylinder mounting plate almost entirely blocks the adjustment points from view. We need to be very specific when making the adjustments, especially since they play heavily into the amp draw of the vehicle while driving. To begin to adjust the rods, we recommend that you remove the nut and jam nut on the pivot bolt shown below. This will allow the complete linkage to drop down from inside the mounting bracket.



Once you have this pivot bolt removed and the linkage hanging down, the end that goes into the master cylinder will be able to swing down and free. Inside the master cylinder, there are two pistons, one at the front that works the front brakes, and one at the rear that works the rear brakes. These two pistons are not connected to each other, but have springs that keep them separated a measured distance.

At this point, it is important to know the description of the vehicle's issue. If the brakes are dragging, the cause can be the front brakes only, if the rod is pushed in slightly, to moderately. Or all the brakes can stay applied if the pushrod is pushed in farther. Another issue can arise where there is no rear brake application at all, depending on if fluid can access the rear piston. When bleeding the rear brakes, this can also prevent the fluid from ever coming out at the rear bleeder valves.



Without realizing it, there are many times when the wrong rod is adjusted, because it is the only one that is visible from outside the mounting bracket. This is the rod that actually adjusts the pedal free-play. And depending on how this is adjusted, it can actually introduce a brake problem or make an existing one worse!

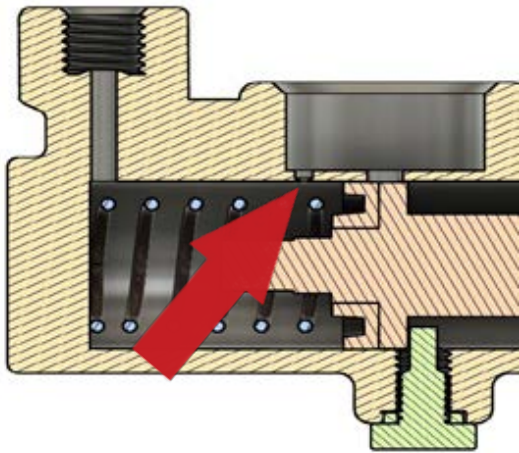

In this diagram, you can see where the brake fluid travels into the master cylinder bore, for the rear brake circuit. There is a cup seal that is meant to keep the rear circuit fluid separate from the front circuit. It is what creates the pressure in the rear circuit when the pedal is pushed down.

As the piston and seal move backward, they close off the fluid port, so that the fluid can't escape back through the port it just entered through. And this is how it's meant to work properly.

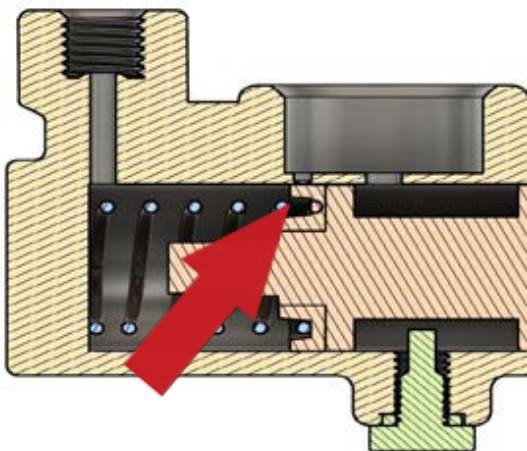

In this diagram, it shows how the piston and seal move backward, and close off the fluid port. With proper pushrod adjustment, this is normal operation because it allows the fluid for the rear circuit to fill the bore behind the piston.

But if the pushrod is adjusted too far into the master cylinder, this piston and seal can prematurely close off the fluid port. This will not allow fluid to enter or fill the rear brake circuit. This will not allow fluid to come out of the rear brake bleeder valves or for the rear brakes to operate at all.

Here is the normal view from under the vehicle. As you can see, the linkage is almost completely shrouded by the mounting bracket. You will not be able to visually tell if the pushrod is adjusted correctly. So you will need to use the customer's complaint as your guide, by checking the amp draw, by checking that the wheels free spin, and by checking the adjustment by hand.

Many times, with these concerns, an infrared temperature gun will help identify wheels that are experiencing more friction than others. The temperature readings can then be compared against the opposing side of the vehicle.



Always adjust this rod **SECOND**, after adjusting the master cylinder pushrod. **THIS** rod adjusts the pedal free-play and pedal feel

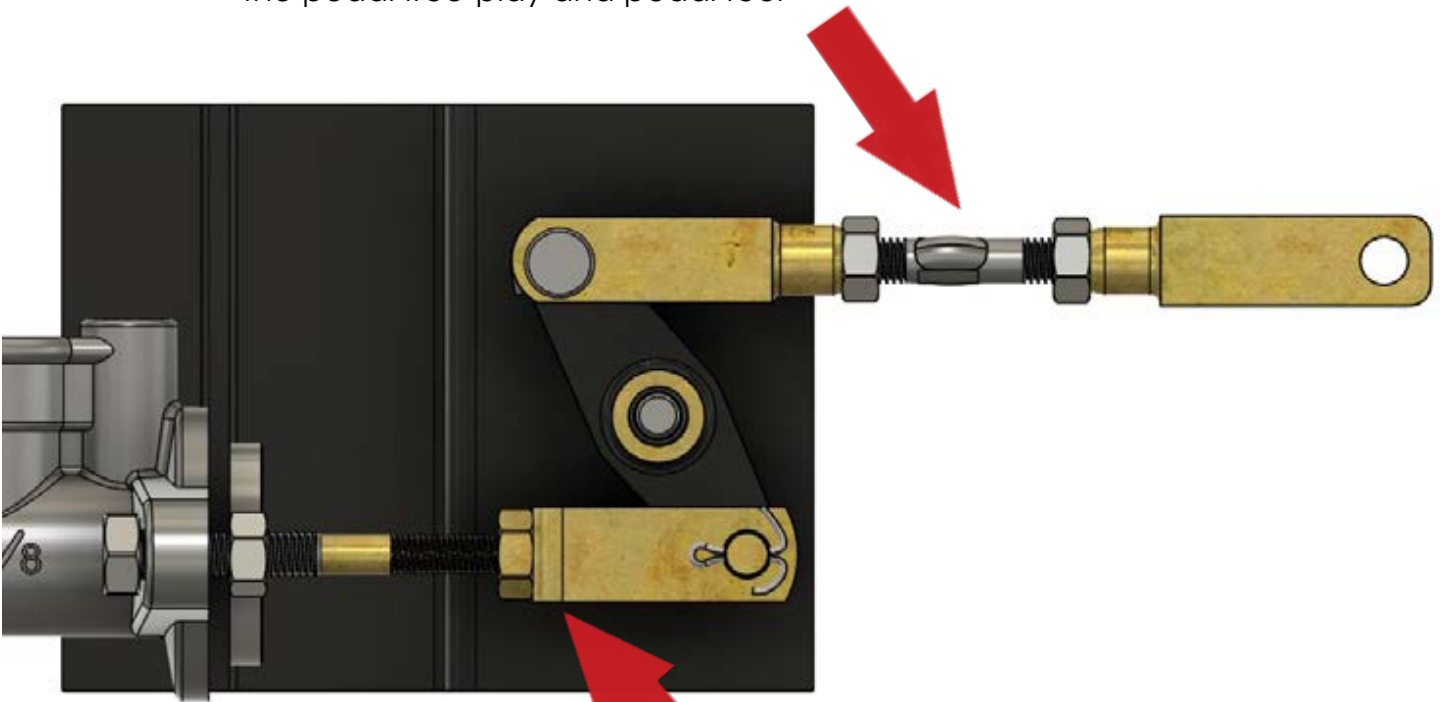

Adjust this rod **FIRST**, especially when there is a brake drag issue.

To adjust this rod, it should be able to turn freely with your fingers when inserted into the master cylinder piston cup. This indicates there is no pressure on the pushrod. Then adjust the rod until it just stops turning. This will indicate when it has made contact with the piston cup. Now you are ready to bleed the brakes properly, or move on to adjusting the pedal free play.

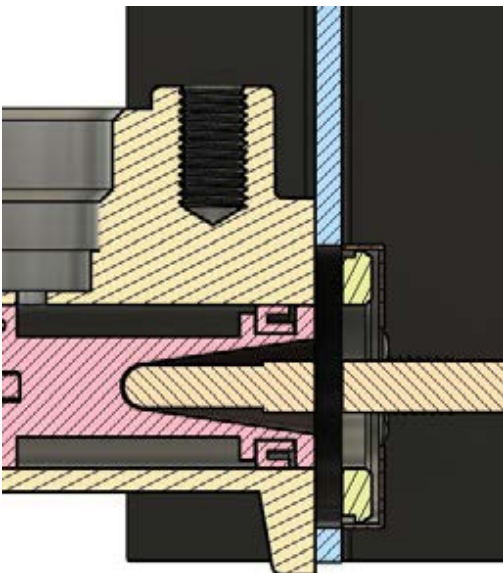

Any time there are brake issues, whether front or rear, not applying, or staying applied, start here with this adjustment. This adjustment will be the main suspect when the battery has limited range.

Each of the wheels should be able to free spin by hand, when off the ground. Wheel bearings can also cause wheel dragging issues, in vehicles with either brake system. An indicator whether there is a wheel drag condition is the amp draw of the motor. The recommended amp draw range is 75-90 amps for lifted cars, especially for long cars, and 65-75 amps for short cars.

This can be found and checked in Monitor>Controller>Current RMS, using the Curtis handheld programmer. If the amp draw is above these readings, there is a wheel drag condition that needs to be resolved, especially on lithium-equipped vehicles.

R&R 4P Brake Pedal Assembly



To remove the four passenger brake pedal assembly, you will remove the dash, and remove the bottom floor bolts from the seat pod so that it can be raised up slightly along its front edge. For this, you will need an impact wrench with #1 and #2 Phillips bits, 12mm wrench, 10mm wrench, 5mm Allen socket and ratchet, with a wide scraper or putty knife. You will also need a plastic trim removal tool, and a drill with a 1/4" drill bit.



With the impact driver and Phillips bit, remove the four Phillips screws along the upper edge of the dash, securing it to the front body.

Using the same Phillips bit, you will remove the trim screws from around the parking brake pedal. Depress the pedal down, in order to remove the trim cover.



Using both Phillips bits, and the 10mm wrench, you will remove the Phillips screws and other hardware from the two rocker panels. Remove the rocker panels from both sides of the vehicle and set aside.



Continue to remove the dash, as outlined in our Dash section. Drill out the 10 pop rivets that secure the dash to the floor.

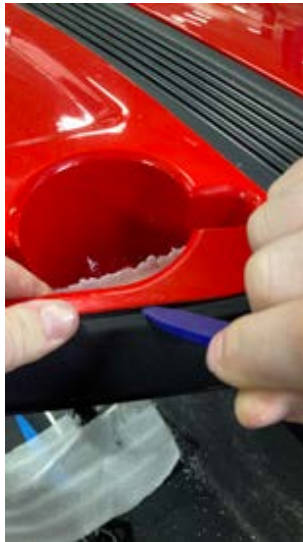

Using the plastic trim removal tool, you will pry up on and remove the center dash cupholder

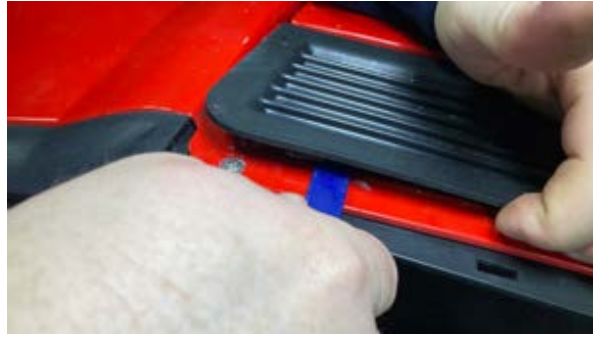

followed by the center dash louvered vent trim.



With the #3 Phillips bit and 12mm wrench, you will remove the three screws that attach the dash to the front body, under the louvered vent trim. These screws also hold the metal clamping strip under the dash, so you will need to capture and keep this metal strip.



Follow the dash removal process, and then beginning at the top edge slowly peel back the floor mat. This is a very delicate process. The floor mat is very prone to tearing, but we recommend purchasing a 2P floor mat any time you are replacing the 4P brake pedal assembly. In either case, you will almost always end up replacing the front section of the mat with a 2P mat.



Continue peeling the floor mat from the floor, along the top edge, moving across the vehicle. Use the wide scraper to help in releasing the adhesive from the floor and mat. This is a slow and methodical process and can't be rushed, so you will need to take your time for best results.



As shown, you will slowly release the floor mat and roll it downward as you go. When you get to the edges of the brake pedal assembly itself, you will need to use the putty knife to cut the adhesive between the floor mat and the pedal assembly. Then carefully pull upward on the mat, working outward from the pedal assembly to meet the already loosened part of the mat.



This is how the floor will look once the mat has been removed. You will remove the front section of mat, to the front of the pod seat. You can cut the mat just ahead of the pod seat, roughly 1" away from the pod seat edge.



Using the Allen socket and a 12mm wrench, you will remove the four bolts that hold the brake pedal assembly to the floor. There are corresponding nuts under the floor as well. These will need to be removed from underneath the vehicle.



Disconnect the white 2-pin connector for the brake switch.



Using a small pair of snips, you will clip the zip ties from the throttle sensor wiring harness. Proceed until you reach the throttle sensor connector and disconnect the connector from the vehicle wiring.



Using a small pair of needle nose pliers to remove the cotter pin that connects the brake pedal linkage to the brake pedal. You will replace this cotter pin with a new one, when going back together with the new pedal set.

Remove the clevis pin, washer, and cotter pin from the brake pedal linkage and let the linkage hang down freely.

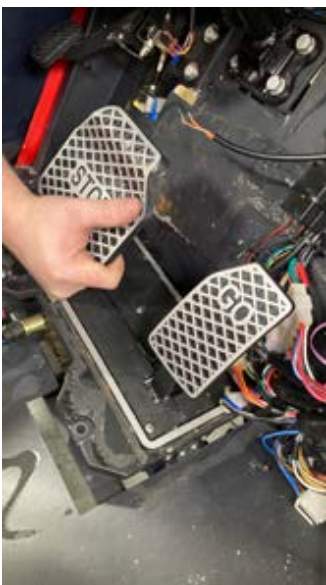

You will now be able to lift up on and remove the brake pedal assembly. The 4P assembly must come out as a complete set, whereas the 2P assembly can be broken down into separate sections for replacement.



Be aware that there are typically leveling spacer shims located around the front mounting screws of the brake assembly. These shims are used to level the leading edge of the brake pedal assembly to the floor.



After removing the brake pedal assembly, you will transfer over the brake pedal switch and throttle sensor to the new unit. Then you will reverse all the removal steps, to complete the installation.

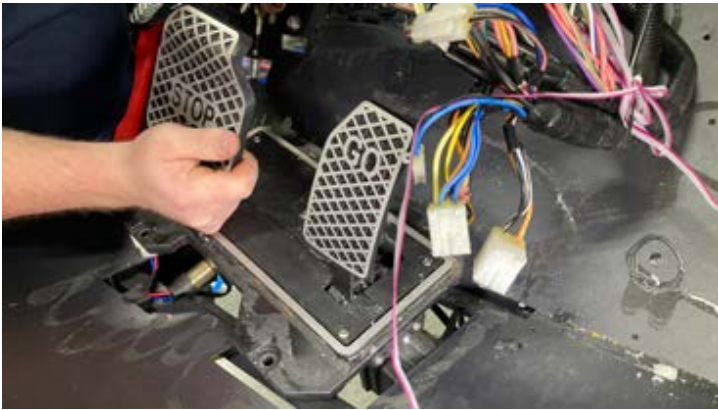

Once the pedal assembly is in place, with the leveling shims underneath and screws in place, we will begin replacing the floor mat.



Here is the two passenger floor mat. It only reaches to the front of the pod seat, in the four passenger cart. This is why we're able to use it in place of the front section of the 4P cart floor mat.

The front edge of both floor mats is the same on both, except for the holes for the steering column and the hole for the separate parking brake. To add these holes, you will use the old floor mat as a template to mark the new mat. Here, we're using a silver Sharpie to add our cutting lines. Then, you'll use a razor knife to cut on your marked lines.

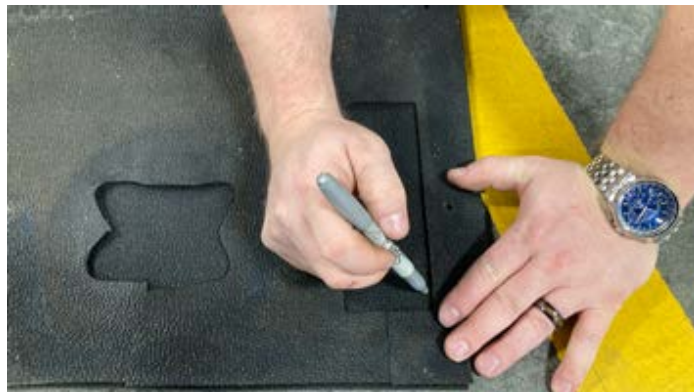

The best way to proceed is to place adhesive around the brake pedal assembly area first. This is the opening you will want to start with, to make sure it is set correctly as your starting point. Set your mat down, into the adhesive, smoothing the mat down around the assembly.



For this repair, we are using Wurth brand, Pro Bond Cal Compliant Adhesive in spray form. This spray is able to go on in a wide coverage for quick application.



Work outward from the brake pedal assembly opening, spraying adhesive on the floor and on the floor mat, pressing down and smoothing as you go. Do not go all the way to the pod seat at this time. Work to the parking brake and steering column area, then to the middle of the floor and up under the dash area.

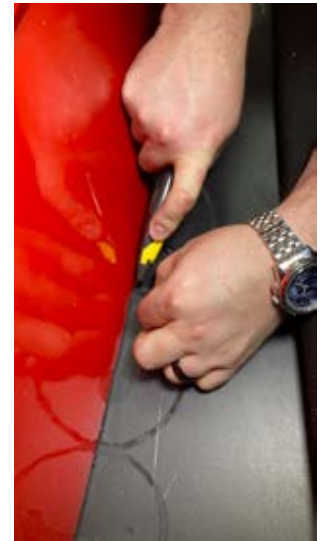
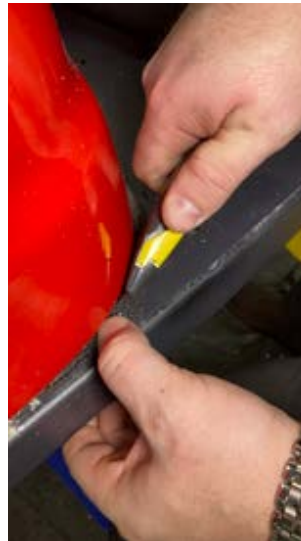

Using the front edge of the pod seat as a guide, you will use the razor knife to carefully cut through the remaining fragments of floor mat. This will allow the new edge of the new mat to be applied over the top of the old mat, that is under the pod seat.

Refer to our section on removing the pod seat, and you will see how to remove the controller cover screws, along with the pod seat to floor bolts. This will allow you to pull upward on the pod seat assembly, wedging some small pieces of wood underneath temporarily.





Apply adhesive just in front of the pod seat, and to the underside of the floor mat. Using some blocks of wood, prop up the front edge of the pod seat. Then, with an assistant's help, slide the edge of the floor mat under the pod seat first so that it is placed safely underneath, before adhering the rest of the mat to the floor. You should now have the entire floor smoothed down and installed.



The closing steps are to trim the excess mat at the side edges of the floor. Bolt down the pod seat, and install the dash with new black pop rivets. Reverse the remaining steps to complete the installation.

Replacing the Manual Brake Pedal



To replace the manual brake pedal, you will need these tools: 5mm Allen socket, ratchet, extension, small flat head screwdriver, pair of needle nose pliers, pick tools and small Phillips screwdriver.

Under the vehicle, you will use the needle nose pliers to remove the cotter pin that retains the pin that connects the brake pedal clevis to the manual brake spring holder.



Using the pick tools, you will remove the hot glue sealer that is over the three tabs that hold the brake pedal assembly trim surround into the floor. Under the hot glue sealer, you will find there are three very small Phillips screws. These screws will need to be removed, to allow the tabs to be bent back, and disengaged from the floor. One of the screws will be at the very corner of the throttle pedal, and very hard to see.



Use a flat head screwdriver to pry upward on the trim surround, lifting it out of the floor of the vehicle.



With the ratchet, extension, and 5mm socket you will remove the four screws that hold the brake pedal into the vehicle from under the vehicle.



Using a knife or small pair of snips, you will cut the zip ties that secure the wiring to the brake pedal switch.



Disconnect the brake pedal switch two pin connector.



When bringing the brake pedal down from below the vehicle, be sure to capture and keep the brake pedal spacer.



To bring the brake pedal down completely out of the cart, you will need to spin the pedal around so that it is facing backward to its normal direction. With it turned around, it will be able to fit down through the opening in the floor. Reverse these steps to complete the installation.

Replacing the Master Cylinder



For replacing the master cylinder, you will need two 13mm wrenches, a Phillips screwdriver, 10mm wrench and two hose clamps or locking pliers you can use to pinch off the hoses from the brake fluid reservoir.



With the 10mm wrench, break loose the brake line fittings, where they go into the master cylinder. Try not to let these lines bounce around too much, so as not to disturb all the fluid inside the lines.



Using the hose clamp pliers, you will pinch off the two rubber hoses that come from the brake fluid reservoir. This will keep all the fluid from draining out, from the reservoir above.



Remove the two master cylinder mounting bolts and nuts, using the two 13mm wrenches. The master cylinder push rod is not connected to the front of the master cylinder. It only fits into a depression in the front piston face. So once the two bolts are removed, the master cylinder will be able to drop down.



You will now use the Phillips screwdriver to loosen and remove the hoseclamps from the two brake fluid hoses, where they connect to the master cylinder.



Remove the two brake hoses from the master cylinder, to complete the removal process.



Before installing the new master cylinder, it must be bench bled! This will greatly reduce the time needed, to bleed the entire brake system. If you don't bench bleed the master cylinder, you may not be able to get all the air out of the brake system at all. After bench bleeding the master cylinder, reverse these steps, to finish replacement.

Replacing Hydraulic Brake Shoes



The tools needed, for replacing the hydraulic rear brake shoes are a dead blow hammer, needle nose pliers, a flat head screwdriver and an impact wrench with a wheel nut socket.

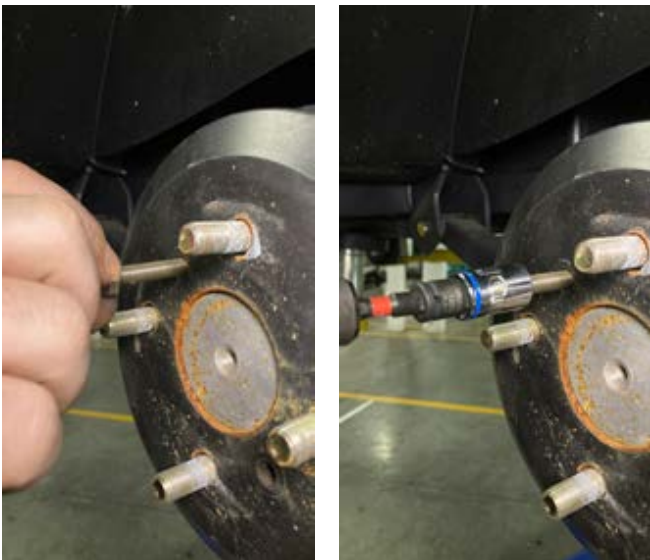

The rear brake drums are equipped with an M8 threaded push-bolt hole, that will let you force the drum away from the axle hub if it is stuck. This can save valuable time, when removing stuck drums.

Using the flat head screwdriver, and needle nose pliers, remove the brake shoe retaining springs that connect the shoes to each other.





Using the flat head screwdriver, you will compress and remove the brake shoe holddown springs. Capture and retain these springs along with the holddown pins they connect to.

On the rearward brake shoe, you will find the parking brake lever secured with a pin and a cotter pin. Around this pin, you will find a flat washer, and a curved spring washer. The flat washer goes against the cotter pin, with the spring washer between the flat washer and the lever.

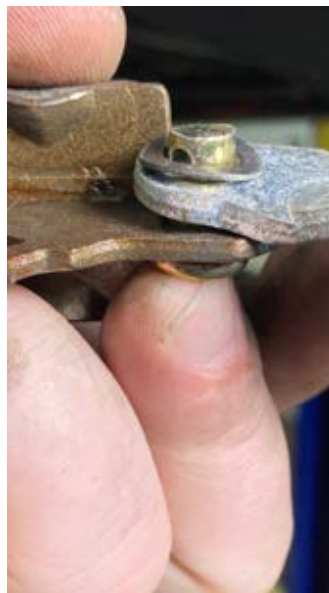

The forward facing brake shoe has a slot where the adjuster connects. Slide the shoe forward and out, to disengage the adjuster finger from the shoe. Reverse these steps to complete reassembly. Before installing the brake drum, you will need to reset the brake adjuster all the way back in its travel. This will let the drum fit over the brake shoes.



Replacing Manual Brake Shoes



The brake shoes can be removed with an impact wrench with a wheel nut socket, needle nose pliers, a flat head screwdriver, a small pry bar and a hooked pick tool.



Remove the rear wheels, and brake drums. Set the parts aside so they can be reinstalled later.



Using your needle nose pliers, remove the upper spring that joins the two shoes together.



Using the hooked pick tool, you will reach behind the axle hub and unhook the brake self adjuster spring. There are two springs that attach to the self adjuster lever. You will want to pay attention to how and where the ends of these two springs attach so they can be reinstalled properly.

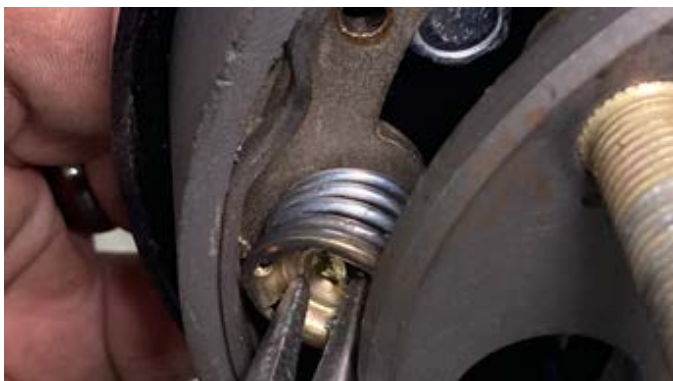

With the needle nose pliers, push in and twist on the shoe holdown springs. There is a small brass colored pin that passes through the spring from the backing plate. You may need to put pressure on the back of this pin while compressing the spring.



With the holdown springs removed, you will be able to pull the top of either brake shoe outward from the axle. While pulling out, you will slide both shoes downward and out of the shoe landing at the bottom of the backing plate.

Both brake shoes will be able to pull away from the backing plate, with the lower spring connecting the two. You will transfer this spring to the new brake shoes, before installing them onto the vehicle. Reverse the removal steps, to complete the replacment.



Replacing the Brake Pads



For this repair, you will need a zip tie, 13mm wrench, 4mm Allen socket and ratchet.



Remove the upper and lower brake caliper bracket mounting bolts. This will let the brake caliper bracket pivot upward and away from the rotor, for pad replacement.



Use the zip tie to hang the brake caliper up and out of the way, so that it is not hanging by the brake hose. You will be able to perform the rest of the repair with the caliper hanging in this manner.



Use the 4mm Allen socket and ratchet to remove the Allen head slide pins from the caliper. These pins travel through the tops of both brake pads. There are holes in the tops of the pads, that slide on these pins.



The brake pads will be able to pull out of the caliper, once the slide pins are removed.

Remove and inspect the brake pad anti-rattle clip. This is located above the brake pads, and clips into the caliper. This clip keeps tension on the pads and keeps them from making clicking and rattling noises. If this clip is loose or damaged, replace it with a new anti-rattle clip.

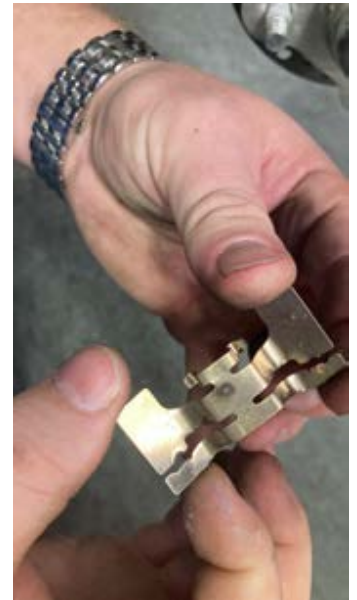

Reinstall the anti-rattle clip and install the new brake pads. Looking through the slide pin holes, you will be able to make sure that the holes of the brake pads are aligned with the slide pin holes. You will need to keep downward pressure on the pads, because the anti-rattle clips are applying pressure in the opposing direction. Insert the slide pins, to keep the brake shoes from popping out of the caliper.



Tighten the slide pins into the caliper. Install the brake caliper mounting bracket bolts and tighten. Be sure that the brake hose is not kinked or twisted. If the hose is kinked or twisted, this will cause intermittent braking issues that can be dangerous.

Replacing the Front Caliper



For replacing the brake caliper, you will need a 12mm wrench, 13mm wrench, and an 8mm wrench for opening the bleeder valve. You will also need an impact wrench with a wheel nut socket. Begin the job by removing the wheel. Use the 13mm wrench to loosen the brake caliper mounting bracket bolts. Do not remove the bolts fully at this time.



Place a drip pan below the brake caliper, to catch any fluid that drains from the caliper. Using the 12mm wrench, loosen and remove the brake caliper banjo fitting bolt. When the bolt is removed, you will find there are two sealing washers that seal the banjo fitting. Discard these washers and the bolt. New sealing washers and bolt will be supplied with the new caliper.



After the mounting bolts are removed, slide the caliper and brake pads upward and off the rotor.



The brake caliper will come off with the brake pads and mounting bracket together as an assembly. To replace the caliper, you will reverse these steps, using the new supplied banjo fitting bolt and sealing washers. You must bleed the brake system after replacing any part of the hydraulic circuit.



Replacing the Front Rotor



For replacing the brake rotor, you will need an impact wrench with a wheel nut socket, zip tie, hammer, flat head screwdriver, small pry bar, ratchet, 6mm Allen socket, Channel Lock style pliers, 13mm wrench, and needle nose pliers. Not shown: Bench Vise



Remove the upper and lower brake caliper mounting bracket bolts, using the 13mm wrench.

Slide the whole brake caliper and mounting bracket assembly upward, off the rotor. Use the zip tie to suspend the caliper assembly so it does not hang by the brake hose.

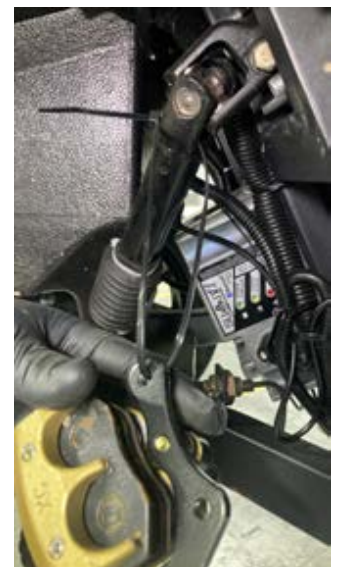

With the hammer and flat head screwdriver, remove the wheel bearing dust cap. Be sure that the dust cap O-ring remains with the dust cap.



Use the needle nose pliers to remove the cotter pin that locks the wheel bearing spindle nut. Use the Channel Lock style pliers to remove the spindle nut. Set the nut aside for reinstallation later. The cotter pin will be replaced with a new one.



Remove the outer wheel bearing and set aside for reinstallation later. Clamp the rotor hub assembly into a bench vise, so you can remove the bolts that attach the rotor to the wheel hub, using the 6mm Allen socket and ratchet.



The two sides of the rotor are not the same. One side is black in the center. This side will face outward from the wheel hub when installed. The bolt heads will clamp down on and contact this surface. The other side is machined flat and this side will contact the wheel hub surface. Be sure that the rotor mounting bolts have each of their lock washers.

The minimum acceptable thickness of the rotor is marked on the black section of the rotor. To finish the replacement, reverse the removal steps, using a new cotter pin in the spindle nut.



Replacing the Front Brake Hose

To replace the front brake hose, you will need an impact wrench with a lug nut socket, 10mm wrench, 24mm wrench, 19mm wrench and 13mm wrench.



Using a 13mm wrench, break loose the banjo bolt that holds the brake hose to the top of the caliper. BE SURE to capture the two sealing washers that go above and below the banjo fitting. You will need these washers to be reinstalled.

With the 10mm wrench, you will break loose and then remove the brake line fitting from the brake hose fitting.

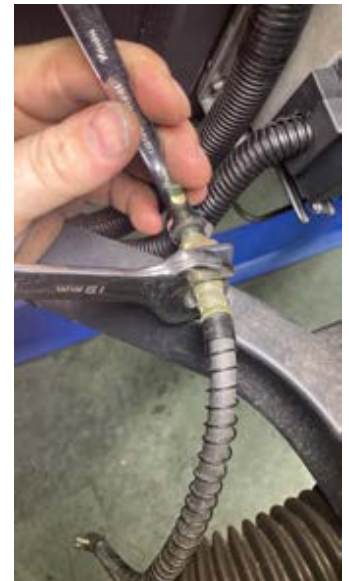

Using the 19mm and 24mm wrenches, break loose and remove the brake hose retaining nut. This will allow the brake hose to come free from its mounting bracket.

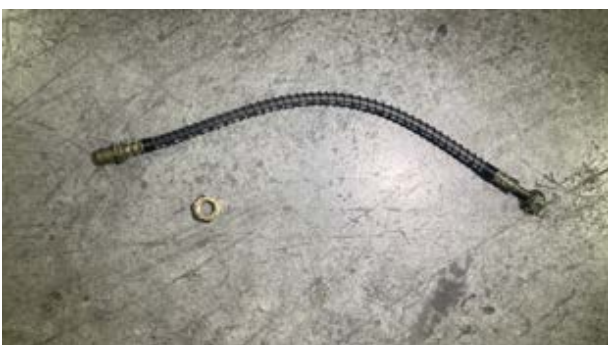

Reinstallation is the reverse of removal. To tighten brake line fittings, it is best to use a flare nut wrench, to prevent rounding the nut flats of the fittings. Be sure to install the brake hose retaining nut, as the hose is inserted into the mounting bracket. Be sure to bleed the brake system.

Replacing the Rear Brake Hose

To replace the front brake hose, you will need an impact wrench with a lug nut socket, 10mm wrench, 19mm wrench, 24mm wrench, 17mm wrench.



Using the 17mm wrench, break the brake hose fitting loose at the wheel cylinder. You will only break this fitting loose, not remove it completely at this time.



With the 10mm wrench, break loose the brake line fitting where it connects to the brake hose. You will completely remove this fitting and slide it along the brake line, so it is disconnected from the brake hose.



With the 19mm and 24mm wrenches, break loose the brake hose retaining nut from the brake hose mounting bracket. Once this nut is removed, the hose will be able to be removed from the bracket.



You will now pull the brake hose free from its mounting bracket, being sure to capture the retaining nut for reinstallation later. Pull the free end of the brake hose back behind the rear shock absorber. This will allow you to twist and spin the brake hose, unscrewing it from the back of the wheel cylinder. Reverse these steps in order to complete the installation. Be sure to install the brake hose retaining nut as soon as you insert the hose end through its mounting bracket. This will make sure it is not forgotten during reassembly. Be sure to bleed the brake system.

Replacing the 4P Parking Brake



To replace the 4 long parking brake pedal assembly, you will need a Phillips manual or powered screwdriver, ratchet, 13mm wrench, needle nose pliers, flat head screwdriver, extension, and 13mm socket.

Using the Phillips screwdriver, remove the three Phillips screws that attach the parking brake pedal to the floor of the vehicle.



To remove the parking brake pedal cover, you will need to press the pedal down and temporarily apply the parking brake. This will let the cover pass over and above the pedal.

With a 13mm wrench, and a ratchet with 13mm socket and extension, you will remove the two bolts that mount the parking brake pedal assembly to the floor of the vehicle. The nuts will be on the opposite side of the floor, and can be reached above the driver side front wheel. Be sure to capture and keep the washers and all the hardware that is removed in this step.





Both of the floor mounting holes, and both of the holes in the pedal assembly are slotted. This is to allow for adjustment, once the pedal is installed.

You will now pull upward on the parking brake pedal assembly, to lift it away from the floor. There will be a three wire harness that connects to the parking brake switch. Record the positions of these wires on the switch, then disconnect the wires from the switch.

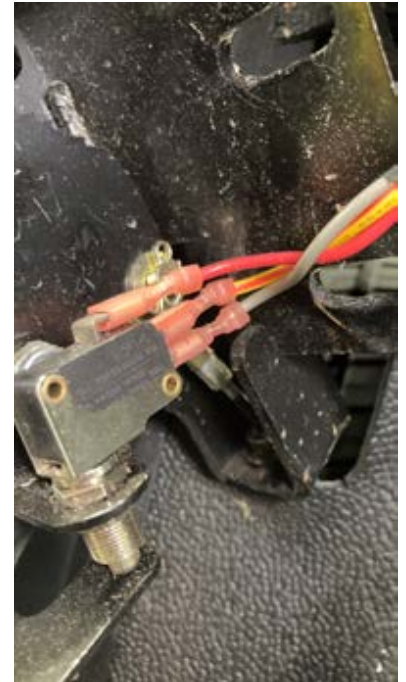

Using the needle nose pliers, you will remove the cotter pin that passes through the pin connecting the parking brake cable to the assembly.

The cable retaining pin will now be able to be pushed out of the parking brake cable. On the other side of the pedal assembly, you will see that there is a hole provided, just for this pin to pass through, for removal. Push the pin out, through this hole in the pedal assembly and keep the pin for installation later.





Using a flat head screwdriver, reaching in through the back of the assembly, you will pry the e-clip from around the parking brake cable housing. This will let the cable pull out from the pedal assembly.

You can now slip the pedal assembly off of the parking brake cable and away from the floor. Reverse these steps to complete the installation. When aligning the pedal to the pedal cover, you may need to use the slotted holes for adjustment. Adjust the pedal as needed, so that it does not contact the pedal assembly cover when the brake is applied or released.

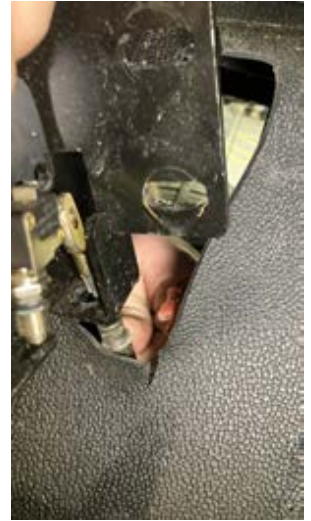

Replacing 4P Parking Brake Switch



To replace the parking brake switch on the hydraulic brake equipped cart, you will need a manual or powered Phillips screwdriver, and a 12mm wrench.

Start the operation by depressing the parking brake. The trim cover will not pass over the parking brake pedal unless the pedal is depressed.



Using a Phillips screwdriver, remove the Phillips screws that hold the pedal trim cover in place.



Lift the trim cover upward, and away from the floor, so that it can pass over the parking brake pedal.



The parking brake pedal switch is located on the inward side of the parking brake pedal assembly. You will notice there are two jam nuts that retain the switch in its bracket. These two jam nuts can be used to adjust the point where the switch activates, according to the pedal travel.



Using a 12mm wrench, you will loosen and remove the lower jam nut from the switch. This will let the switch come free from its bracket. Note the order of the wires that are connected to the switch. This order must be the same, when reconnecting the wires.



Disconnect the wires from the back of the switch, noting the order in which they were removed. Reconnect the wires to the new switch, in the same order they were removed. Reverse the remaining steps, to complete the process. It may be necessary to fine tune the adjustment of the jam nuts, to position the switch so that the plunger switches properly when the pedal is depressed/released. Adjust as necessary before installing the trim cover.

Replacing 4P Parking Brake Cable



To complete this operation, you will need a dead blow hammer, 19mm wrench, needle nose pliers, needle nose vise grips, a small pry bar and a flat head screwdriver.



To begin, using the 19mm wrench, loosen and remove the brake cable retaining nut where the cable connects to the brake equalizer.



The brake cable will now be able to drop down from its bracket. You can now disconnect the cable end from the equalizer.



Using the flat head screwdriver, disconnect the brake shoe springs that connect and hold the rearward brake shoe to the backing plate. The rearward brake shoe is the one that connects to the parking brake cable.



Once the rear brake shoe is loose from the backing plate, you will be able to rotate it down and outward, to disconnect the parking brake cable.



On the back side of the backing plate, you will find a small horseshoe retaining clip that holds the parking brake cable into the backing plate. Use the flat head screwdriver to pry up on and remove this clip.



You will now be able to feed the parking brake cable through the backing plate and remove it from the vehicle.



Installation of the new parking brake is the reverse of removal. Once the new cable is installed, you will need to use the flat head screwdriver to back off the brake adjuster so you can get the brake drum back on. Adjust the brakes as necessary, after the job is completed.

Replacing Hydraulic Backing Plate



For this operation, you will need an impact gun with wheel nut socket, flat head screwdriver, 13mm wrench, needle nose pliers, 90° snap ring pliers, ratchet, 13mm socket, and slide hammer with hub puller attachment.

You will also need a 19mm wrench, 24mm wrench and 12mm wrench, a funnel and DOT 3 brake fluid.



To begin, remove the wheel and brake drum. If needed, you can use the brake drum push hole with an 8mm bolt, to force the drum off of the hub.





With the 19mm wrench, loosen the nut on the front side of the parking brake cable attachment point. You will loosen this nut until it is freed onto the cable itself.

This will allow the parking brake cable to slide out of its slot in the frame mounting bracket. You will be able to remove the cable end ball free from the parking brake equalizer. Be sure to capture and keep the 19mm nut from the end of the cable.



Using the flat head screwdriver and needle nose pliers, remove all the brake shoe holddown springs and set aside for reinstallation later.

After the brake shoes are loose, from removing the springs, you will remove them from the backing plate. The rear brake shoe will have the parking brake lever attached to it, which is activated by the parking brake cable. To remove the cable, simply remove the horseshoe clip that retains it in the back side of the backing plate. This will let the cable come out of the backing plate.



Now remove the snap ring that retains the axle shaft into the axle tube. This is done with the 90° snap ring pliers. The ring will remain captive on the axle shaft.



Attach a slide hammer, with a hub puller attachment, to the axle hub with some of the wheel lug nuts. Use the slide hammer to pull the axle from its bore. When removing the axle, be careful not to damage the axle shaft seal so it doesn't leak fluid after you're finished with the job.



Using the 19mm wrench, break loose the fitting where the brake hose connects to the back of the wheel cylinder. Don't remove the hose at this time. Just make sure that the hose fitting is left loose.

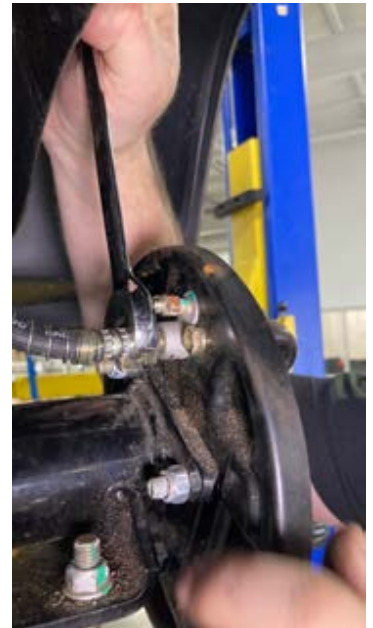

With the 13mm socket, wrench and ratchet, break loose and remove the four bolts that hold the backing plate to the axle tube flange. Set these nuts and bolts aside for later use.



The backing plate bolts have a tapered seat, where they go into a matching chamfer in the backing plate. When reattaching the backing plate, be sure the taper is going in the right direction, and that the new backing plate has the matching chamfered holes.

Reverse these steps to complete the repair.



Be sure to bleed the brakes after any repair that opens the hydraulic circuit. Air will enter the system and prevent the brakes from working properly.



When bleeding the brakes, use conventional automotive DOT3 brake fluid.



A funnel is recommended for adding brake fluid, if you are unsure about it spilling out or missing the reservoir. In either case, do not let the brake fluid contact any painted surfaces. Brake fluid will remove paint from any place where it lands or splashes. Be sure to wipe up any drips immediately, within the pod seat compartment.

Replacing the Manual Backing Plate



You will need a slide hammer, with a hub puller adapter, hammer, 13mm wrench, 13mm socket with extension and ratchet, small flat head screwdriver, hooked pick tool, needle nose pliers, impact wrench with wheel nut socket, and 90° snap ring pliers.

Refer to the previous section, for removing the brake shoes. Then, refer to the Drivetrain section for removing the axle.

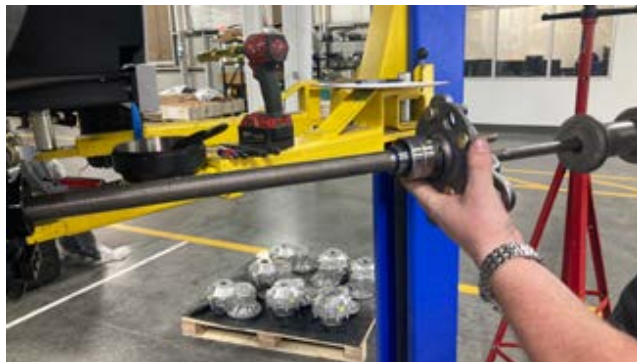

Once the axle has been removed, you will use the needle nose pliers to remove the cotter pin from the brake cable lever pin. Remove the pin and set it aside. You will replace the cotter pin with a new one, upon reassembly.

Disconnect the brake cable from the brake lever. Next, we will disconnect the cable from its bracket on the backing plate.





Using the small flat head screwdriver, you will pry the small C-clip out of its groove in the brake cable. This is where the cable comes through the bracket on the backing plate.

To remove the cable from the bracket, you will need to pull forward on the spring, while at the same time, pulling back on the brake cable shroud. This will create enough space for the cable to fit through the opening in the brake cable bracket.



Using the ratchet with 13mm socket and 13mm wrench, you will remove all four of the backing plate mounting bolts and their nuts from the axle tube.



The backing plate can now be removed from the vehicle. Pay particular attention to the orientation of the brake cable bracket. Reverse these steps to complete the installation.

Steering & Suspension

Description:

The Sirius vehicle features a double wishbone, suspension in the front, with a solid rear axle in the rear. The occupants enjoy a smooth ride, due to the adjustable coilover shocks at each wheel. The ride quality can be adjusted by using the 3 inches of adjustment on each shock, but keep in mind the ride height is adjusted alongside the ride quality.



The Sirius can be equipped with hydraulic or manual brakes, and can be outfitted with a stock or lifted suspension. For the lifted suspension, the spindles and trailing arms are extended.

Table of Contents

Ride Height Adjustment	259
Adjusting Alignment	261
Replacing Trailing Arms	264
Replacing the Front Shocks	267
Replacing the Rear Shocks	269
Replacing Upper Control Arms	270
Replacing Lower Control Arms	272
Replacing the Steering Wheel	276
Replacing the Intermediate Shaft	280
Replacing the Tie Rod End	283
Replacing the Steering Rack	285
Replacing the Front Spindle	288
Replacing the Front Wheel Bearings	291

Setting the Ride Height

The Sirius vehicle ride height can be altered by adjusting the coilover shock absorbers. You will find a spring seat nut, where the coilover spring resides, with a jam nut below it. This is how to make adjustments to the shocks.

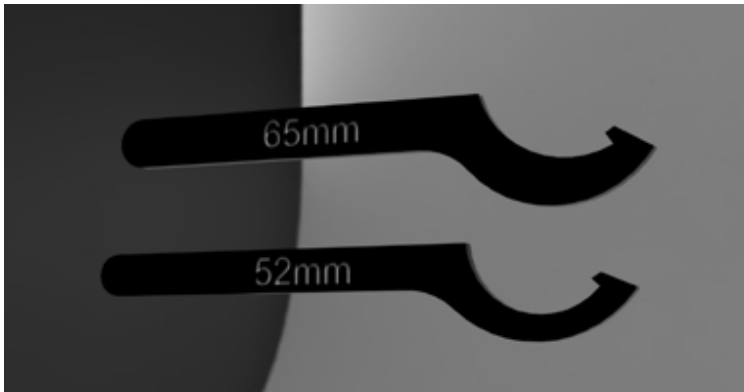

To make these adjustments, you will need two spanner wrenches, sizes 52mm and 65mm. These wrenches can be purchased through Amazon, and usually come in a set of four wrenches.



To begin, measure and record the original ride height, at 4 points near the corners of the vehicle, for reference. Then you will use the 52mm spanner wrench to loosen the lower jam nut, to make space for the spring seat nut to travel either up or down the body of the shock absorber.

Once space is made between the jam nut and spring seat nut, you can use the 65mm spanner wrench to loosen the spring seat nut to lower the vehicle ride height. NOTE: lowering the ride height will soften the vehicle ride quality.



To raise the vehicle ride height, you will use the 65mm spanner wrench to turn the spring seat nut clockwise. This will compress the spring more, and raise the vehicle. NOTE: raising the vehicle ride height will stiffen the vehicle's overall ride quality.

Double check the same 4 corner reference points on the vehicle, to verify the correct adjustments were made. **Be sure to tighten the jam nut back against the spring seat nut after adjustments are complete**



There are a few points that ride height adjustments won't correct. You will want to rule these out beforehand, to make sure that a ride height adjustment will cure the issue.

These items can be:

- The rear wheels too close to the rear bumper. Space the rear bumper out from wheels using spacers.
- Rear axle not centered under vehicle. Loosen trailing arms, and center rear axle side-to-side, then re-tighten U-bolts.
- Verify rear trailing arms are not cracked or breaking at the bend.
- Rear axle weldments cracked or broken. See TSB for rear weldment.
- Rear axle center pins not lined up in the trailing arm centering hole when u-bolts were tightened. This can create a dimple in the trailing arm, or even push the centering pin completely out of the weldment pad. This will cause the axle to slide forward or back, along the trailing arm and changing the alignment.



Setting the Alignment

The Sirius front suspension provides for all the common alignment adjustments that you'd expect from a typical automotive front end. Although there are many similarities, the way the adjustments are made, will be slightly different.



The main thing to note, is that the suspension adjustment move opposite from what you would normally assume. Shown here, the green bracket is the part that moves when adjusted. The red part is part of the frame, and remains stationary. **NOTE: Do not loosen the bolt where it goes through the red piece.**

The camber and caster adjustments are made using the upper control arm mounting points only. Before making adjustments you will need to loosen the mounting bolt nut. This will allow the mounting bolt to slide laterally within its slot. Loosen this nut for each mount that you intend to adjust.



To adjust **caster**, you will adjust the **front** upper control arm mount only. Turning the two nuts clockwise will adjust the caster more negative. The adjustment bolt does not turn, only the rear nuts that move the green bracket.

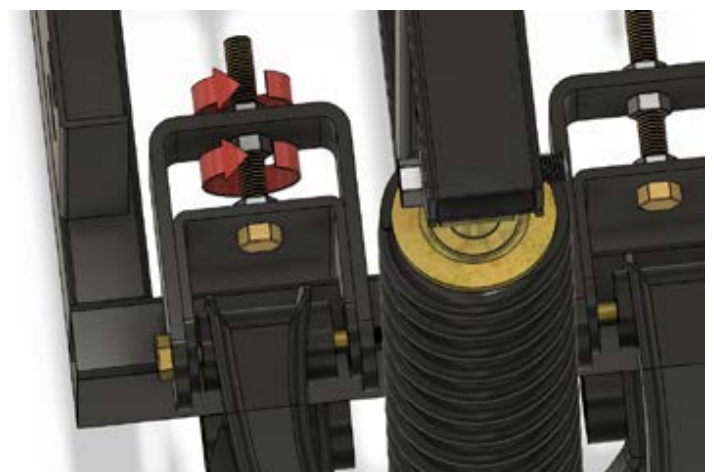

Conversely, turning the two nuts counter clockwise will adjust the caster more positive.

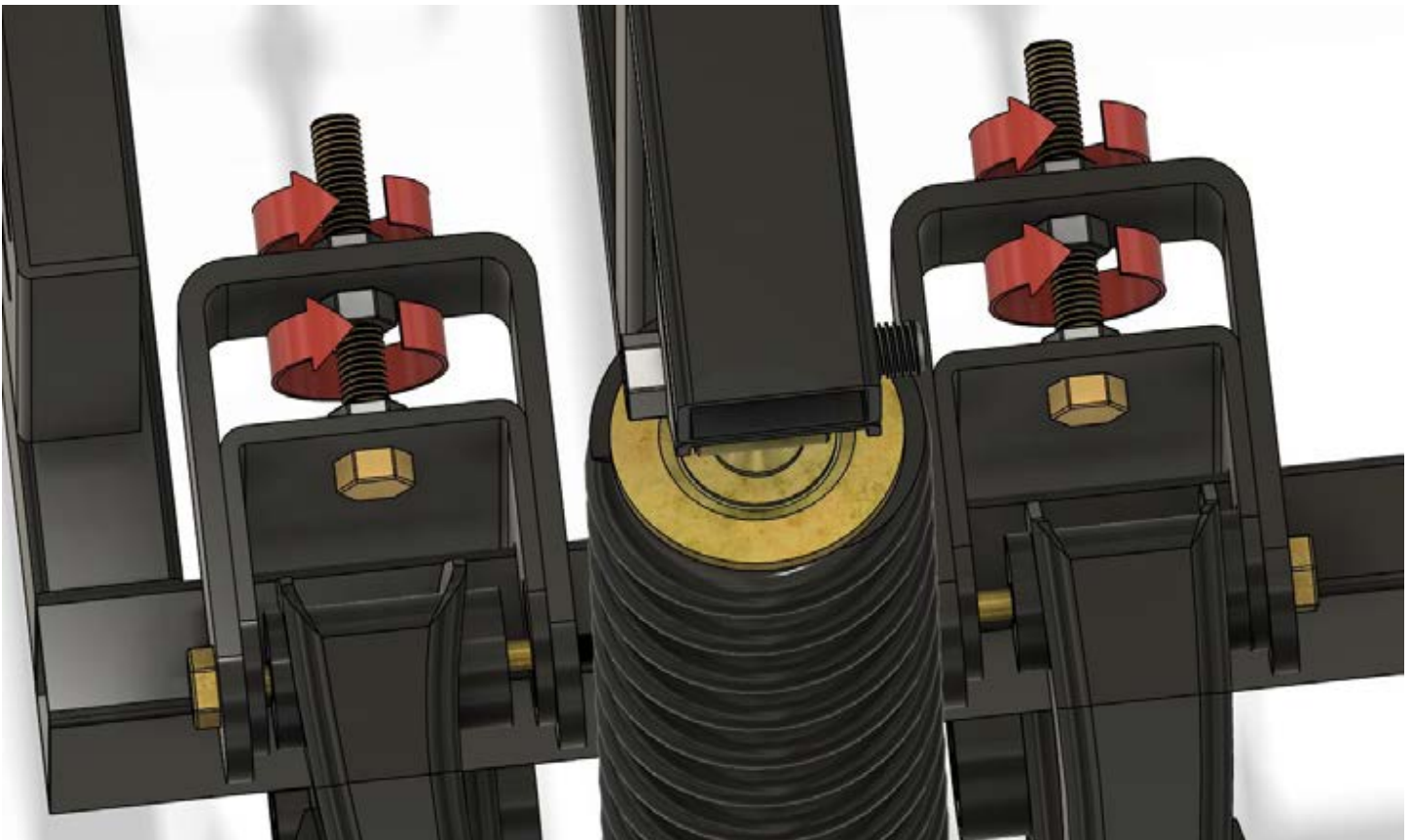
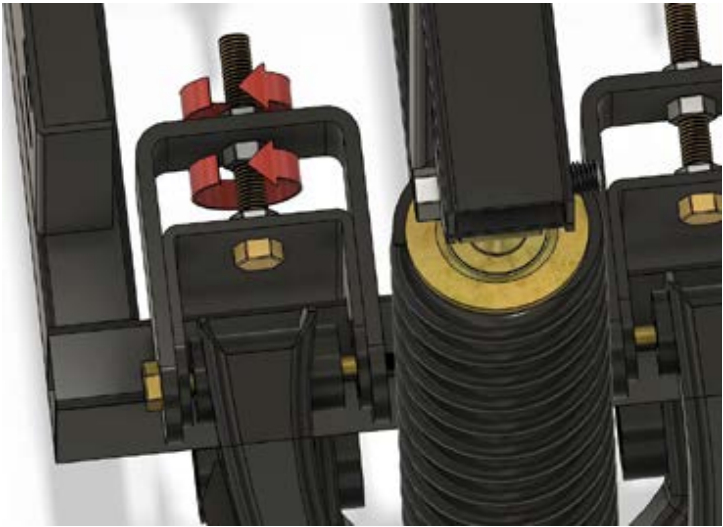

To adjust camber, you will need to move both upper control arm mounting points in or out, depending on the desired effect. To make the camber more negative, (top of the wheel moving inward) turn all the four adjustment nuts clockwise.

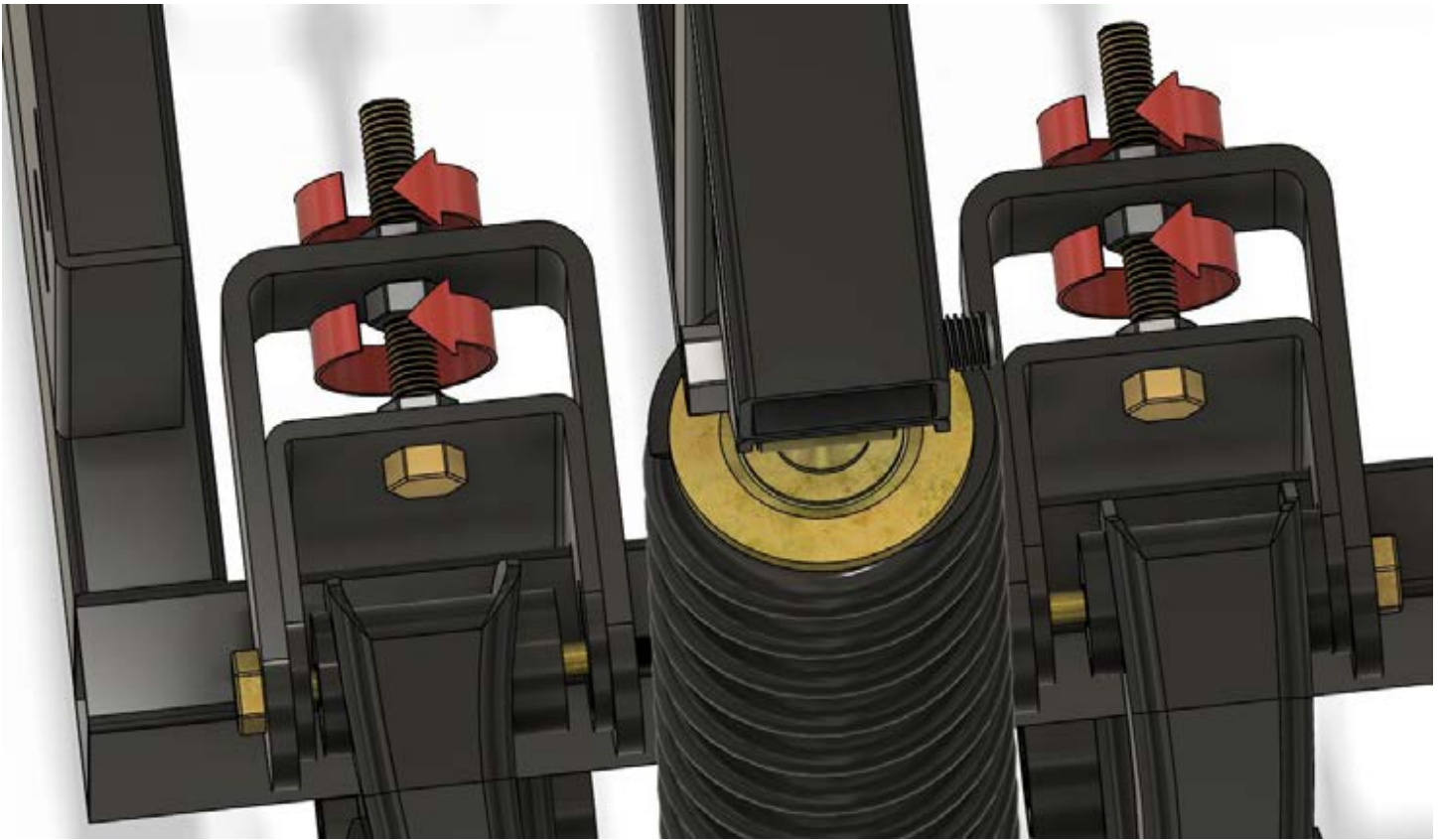

To make the camber more positive (top of the wheel moving outward) turn all four of the adjustment nuts counter clockwise.

Specification	Unloaded State	Loaded State
Camber	0.5-1°	20-30mm
Toe-in		5-8mm
Centerline of wheels (at ground contact point)	930mm +/- 10mm	
Coilover Shock Threads Visible Below Jam Nut	20-30mm	20-30mm

Replacing the Trailing Arms



To replace the trailing arms, you will need these tools:

- 3/8" Impact gun
- 19mm wrench
- 18mm wrench
- 13mm wrench
- 3/8" ratchet
- 3/8" 19mm deep socket
- 3/8" 13mm shallow socket
- 3/8" 14mm deep socket
- 3/8" 18mm deep socket
- Dead man lift support or
- Floor jack with jack stands
- 3/8" torque wrench
- Dead blow hammer



To replace the trailing arms, raise the vehicle at least enough to raise the rear wheels. This will allow enough space for the rear end to be maneuvered into place, to line up the new trailing arm. If you are using a jack and stands, use the stands to support the vehicle, so you can use the jack to raise and lower the rear end assembly. In our case, we are using a vehicle lift and a dead man stand. Be sure that nothing is blocking the trailing arm from swinging downward, once the bolts are removed. It will need to pivot down, so it can be removed from the vehicle.



Use either the jack or a dead man to support the rear end. Using a ratchet and 14mm deep socket, break loose the 4 u-bolt nuts. Once they are broken loose, you can then use the impact gun to remove the nuts completely. Set the u-bolts aside, because they will need to be replaced. U-bolts stretch when used, so you will need new bolts with the trailing arms.



Using a 19mm wrench with an 18mm socket or vice versa, you will loosen and remove the large trailing arm mounting bolt where the trailing arm attaches to the frame. This will let the trailing arm swing down and out of the vehicle. We typically only work on one side at a time. This keeps the rear end from being able to swing around unpredictably.

Replace the trailing arm bushings when replacing the arms. Also, note whether your trailing arm bolt has a shoulder on it. If it does, you can simply use it to install the new arm.



If your bolt does not have a shoulder on it, refer to TSB #TE11027.00 for replacement information. These bolts should be replaced with the shoulder type bolt.



Install the new trailing arm, with the new bushings and the new shoulder bolt into the frame mount, installing the nut with fingers only. You will need to swing the trailing arm into position under the rear end and installing the u-bolts before tightening the frame bolt.



Be sure to align the rear end center pin with the hole in the trailing arm before installing the u-bolts. Install a u-bolt while making sure the center pin doesn't fall out of its mating hole.



Install and tighten the u-bolt nuts and torque to the specs in the torque spec section of this manual. Tighten the frame mounting bolt now, using the torque spec at the back of this manual also.

Replacing the Front Shocks



To replace the front shock absorber assemblies, you will need a pry bar, a center punch, dead blow hammer, 3/8" impact gun or a 1/4" impact gun with a 1/4" to 3/8" adapter, 3/8" ratchet with 3/8" 16mm deep socket, and a 14mm wrench.

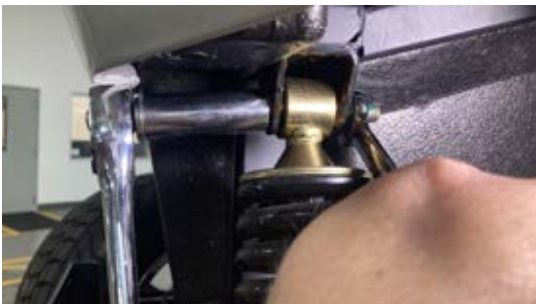

Using the 3/8" ratchet attached to the 16mm socket you will break the upper shock bolt loose, with a 14mm wrench on the nut. You can switch to the impact, to fully remove the bolt from the top eye of the shock.



Next you will move to the bottom end of the same shock assembly. Break the bolt loose, using the same tools as from above. When you remove this bolt, the shock will spring down, so be prepared for this movement. It won't shoot out, but it will spring downward.



The shock is ready to be taken out of the vehicle. To remove, lift the shock upward, and free from each of the two end brackets.



To install the new shock, you will maneuver it into place, starting with the top bracket. Install the top bolt, with the nut on the back side.



To get the bolt to start into the bottom eye, you will need to pry between the lower control arm and the eye of the shock. We insert a center punch into the eye hole from the back, once the shock is pried into place. This will allow you to start the mounting bolt into the

shock. Run the bolt into the hole, until you can pull the punch out. Finish by using the pry bar to align the bolt with the hole in the rear bracket. Tighten the nut to the torque spec in the torque spec chart at the back of this manual.

Replacing the Rear Shocks



For replacing the rear shocks, you will need a 14mm and 16mm wrench, and a ratchet with 16mm socket.



You will remove the lower shock mounting bolt with the 14mm wrench on the nut, and 16mm wrench on the bolt.



The upper shock mounting bolt will require the ratchet and 16mm socket, due to the available clearance. The 14mm wrench will hold the nut. Remove the shock absorber, and reverse the removal steps to reinstall.



Replacing the Upper Control Arms



The tools you will need, are a hammer, pair of needle nose pliers, 16mm wrench and 16mm socket with a ratchet, a 19mm wrench and an impact wrench with a 19mm socket. The needle nose can be substituted with a pair of diagonal cutters, for removing the cotter pins from the ball joint castle nuts.



Remove the cotter pin from the upper ball joint castle nut. You will replace this cotter pin with a new one, after reinstalling the castle nut. Do not use the old cotter pin. There is a flat washer above the castle nut as well. Be sure to keep this washer, for reassembly.



Using the 19mm wrench, remove the castle nut joining the upper control arm to the top of the spindle.

Tapping on the spindle, where the upper ball joint connects, will dislodge the joint from the spindle. It is best practice to leave the ball joint nut on the threads, so that they aren't damaged if the hammer should accidentally contact them. Once the spindle is knocked free, you will be able to remove the nut and flat washer above.

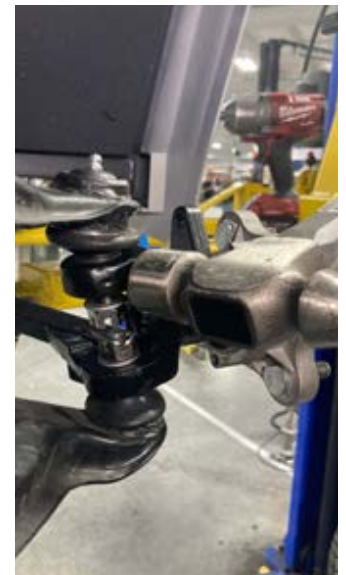



Use the 16mm wrench and 16mm socket with ratchet to remove the upper control arm bolts where they attach to the upper control arm mounts. Removing these bolts will leave the upper control arm free for removal from the vehicle.



Reassembly is the reverse of removal. Be sure to use new cotter pins whenever you remove them. Do not re-use old cotter pins.

Replacing the Lower Control Arms



You will need an impact wrench with a 13mm wrench, 19mm socket, a hammer, a pair of channel lock style pliers, a pair of needle nose pliers or diagonal cutters, a 16mm wrench, 16mm socket, ratchet, 19mm wrench. A short extension and a medium length pry bar can also be helpful.



Use the pliers to remove the cotter pin from the lower ball joint castle nut. Always replace old cotter pins with new ones, upon reassembly. Be sure to notice there is a flat washer below the ball joint nut. This washer will need to be reinstalled under the nut later.

Using the 19mm wrench, remove the lower ball joint castle nut. It is best practice to leave the nut on the threads, so that the threads are not damaged if the hammer should contact them during the next step. We have removed the nut, for viewing purposes.

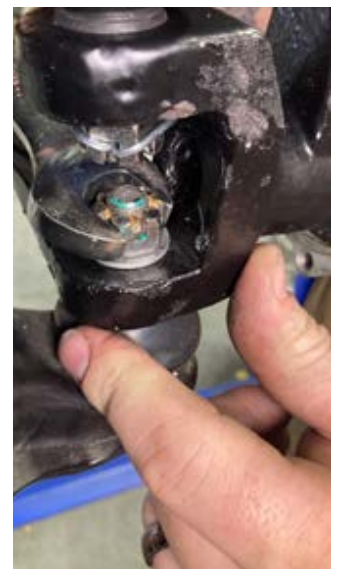



Using a hammer, tap on the lower spindle connection point, where the lower ball joint connects. This will dislodge the lower ball joint in its bore.

Pulling upward on the spindle assembly, you will be able to free the lower ball joint from the spindle. Once free, you can position the spindle to the side of the lower ball joint, to proceed with the rest of the removal.



Using the 19mm socket with short extension and ratchet, and a 19mm wrench, remove the lower mounting bolt for the front shock absorber.

Disconnecting the lower shock mount will allow the lower control arm to swing down. Next, you will remove the lower control arm mounting bolts from their frame mounts.





To remove the front lower control arm mounting bolt, use the 16mm wrench and 16mm socket with ratchet. This bolt is readily accessible, and can be removed without clearance issues.



To access the rear lower control arm mounting bolt, you will need to lower the steering rack from the vehicle. To do this, begin by removing the cotter pin from the castle nut on the outer tie rod end, where it goes through the spindle. Next use the 19mm wrench to remove the outer tie rod end nut. Use a hammer to tap on the spindle where the outer tie rod end joins to it. This will allow the joint to separate. Be sure to capture the flat washer that is below the castle nut.



With a 16mm socket, a ratchet, and a 16mm wrench remove the three steering rack mounting bolts from where they mount the steering rack to the frame.

A 13mm wrench will remove the intermediate shaft pinch bolt, where the intermediate shaft connects to the steering rack input shaft. You will use a pry bar to slide the intermediate shaft upward on the input shaft.





You will lower the steering rack down low enough to let the lower control arm mounting bolt to pass over the top of it, when the bolt comes out. As shown, the bolt has a clear path to exit the frame mount, without hitting the steering rack.



Using the 16mm wrench and 16mm socket with short extension and ratchet, remove the rear lower control arm mounting bolt. This will let the lower control arm come free from the vehicle.

Swing the lower control arm down, and then away from the frame mounts. You can pry down on the control arm bushings, to help with removal. When reassembling, be sure to use new cotter pins in all castle nuts. Be sure to reinstall the flat washers under the castle nuts also.



Replacing the Steering Wheel



To replace the steering wheel adapter, you will need to have a torque wrench with a ratchet, 3" extension and 24mm socket. These are shown in 1/2" drive but you can use 3/8" drive tools also.



To replace only the steering wheel, you will need a 3/8" ratchet and 3/8" 4mm Allen socket.



To replace either component, lift up on the center trim cap of the steering wheel. Set this cap aside, for later use. Make sure you turn the wheels to point straight forward. This will ensure there are no issues with the turn signal canceling pins.

Using the 24mm socket, you will break loose and remove the large center nut that holds the steering wheel adapter to the steering column center shaft. Remove the nut and set aside for later use. Remove the washer that is under the nut. Pull upward on the steering wheel to remove it together with the adapter.





Using the 4mm Allen socket and ratchet, remove the flat head Allen bolts that secure the steering wheel to the adapter. If you are replacing the adapter, this will separate the steering wheel from the adapter. If you are replacing the steering wheel only, you do not need to remove the large center nut. You will only remove the 4mm flat head bolts and leave the adapter intact.



Torque the 4mm bolts and center nut using the torque specs at the rear of this manual. Replace the steering wheel center trim cap after torquing all the hardware.



Replacing the Steering Column



To replace the steering column, you will need an impact wrench, with 16mm socket, 13mm wrench, Phillips screwdriver, and ratchet.

To begin, you will remove the steering wheel, and refer to the section for replacing the combination switch.



Remove all components from the upper steering column, leaving the electrical connections in place. Set the trim covers, etc aside, with all their wiring still connected.



Use the Phillips screwdriver to remove the four screws that attach the upper steering column bracket to the steering column down tube.



You can now slide the upper steering column bracket upward and off the steering column down tube.





Moving under the vehicle, use the 13mm wrench to remove the upper bolt from the upper intermediate shaft collar. Pull downward on the collar, to release it from the bottom end of the steering column shaft.



Pull upward on the lower rubber trim boot that conceals the steering column to floor mounting bolts. You will slide this boot upward so you can access the mounting bolts.



Use the impact wrench, extension and 16mm socket to remove the lower steering column mounting bolts. Capture these bolts and keep them for reinstallation later.



To install the new column, you will insert it through the rubber boot first. Keep all the wiring harnesses to the left side of the column, when inserting, as shown. Once through the boot, you will be able to maneuver the base of the column into place, over the mounting bolt holes. Reverse the remaining steps to complete replacement.

Replacing the Intermediate Shaft



To replace the intermediate shaft, you will need a 13mm wrench, a flat head screwdriver and a pry bar. It may also be helpful to have a hammer.



Begin by aligning the front wheels so they are pointing straight forward. Then place a mark on each of the intermediate shaft collars, where they line up with the steering column shaft and steering rack input shaft. Place a corresponding mark on each of the shafts. These marks will help to keep the steering wheel straight during the process.

Using the 13mm wrench, loosen and remove the pinch bolts from both of the intermediate shaft pinch clamps. Set the bolts aside for reassembly.





With a pry bar, pry the upper collar off of the bottom of the steering column shaft. Try to keep the steering column from turning while removing this collar.

You can now pry upward on the lower intermediate shaft joint, releasing it from the steering rack input shaft. Try to keep the shaft from turning, while removing this joint.

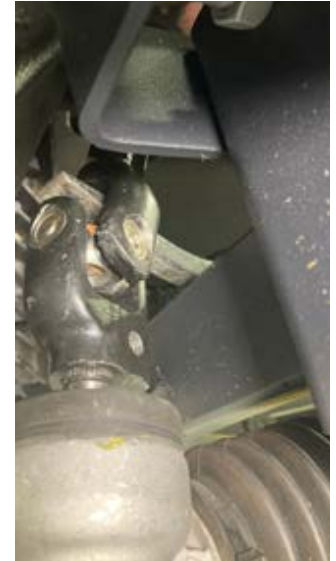

You can now transfer the alignment marks from the old intermediate shaft to the new one. But this is not necessary if neither of the two shafts turned during removal. This can cause an issue with the turn signal canceling, if the shafts have turned.



When reinstalling the pinch collars, the pinch bolt must align with this machined groove in each shaft. This ensures the collar is the proper distance onto the shaft, as well as locking the collar from coming detached from the shaft.

In each of the collars, you can visually see if the shaft groove is aligned with the pinch bolt hole. If this groove is not aligned with the bolt hole, stop and realign the collar.



The same is true for the lower pinch collar. Make very sure that you can visually see the machined groove inside the pinch bolt hole before installing the pinch bolt.

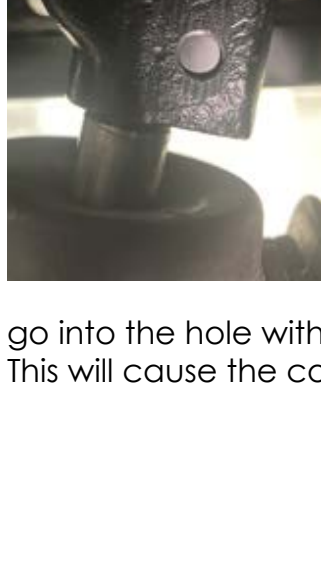

When installing the pinch bolts, it is also imperative that the bolts is inserted into the pinch collar in the direction toward the pinch collar bolt hole threads! In the photo to the right, the pinch bolt could be installed into the threads, but the opposing hole has no threads, so the bolt would tighten, but not pinch the clamp closed around the shaft. The bolt should go into the hole without threads, so as to catch the threaded hole. This will cause the collar to pinch closed when the bolt is tightened.



Replacing the Tie Rod End



For this repair, you will need a jack stand, hammer, channel lock style pliers, or diagonal cutters, and a 19mm wrench.

taken out of the tie rod end. The suspension should flex upward on the jack stand side. This will help the tie rod end come out of the spindle easier. Be cautious of the fact that the rest of the vehicle may raise off of other lifting points, with the jack stand pushing upward on the front corner.

With the vehicle supported off the ground, place the jack stand under the lower control arm on the same side as the tie rod end that needs to be replaced. Lower the vehicle onto the jack stand so that some of the angle is



Using a pair of pliers or diagonal cutters, remove the cotter pin from the tie rod end castle nut and discard the cotter pin. You will replace this cotter pin with a new one, upon reassembly.



Use the 19mm wrench to remove the tie rod end castle nut. Leave the nut with a few threads remaining before coming off the tie rod end. Use the hammer to tap on the spindle. This will dislodge the tie rod end. The tie rod tapered shaft may pop loose, without looking like it has released. It may be necessary to pry down on the tie rod end, to verify the tapered shaft has released from the spindle. Be sure to capture the flat washer that is under the castle nut. This will be reinstalled during reassembly.

Use the 19mm wrench to break the tie rod end jam nut loose.

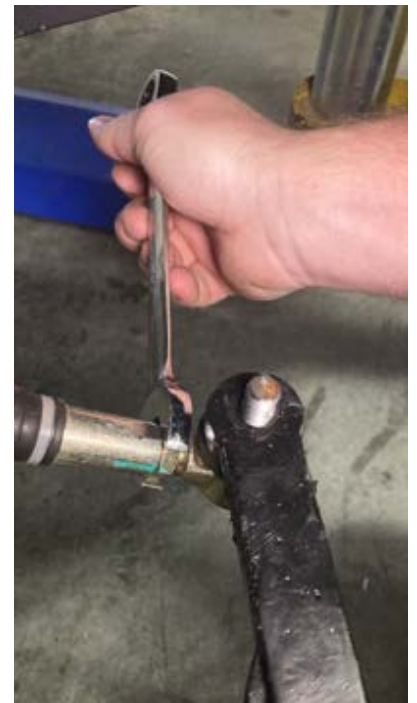

Pry downward on the tie rod end, to release it from the spindle. Once it is free, you can swing the spindle over and out of your way. When removing the tie rod end, you will count the number of full turns that are needed, to remove it. This is the same number of turns that will be required to reinstall the new one. Once the new tie rod end is installed with the same number of turns, you will reverse the removal steps to finish the replacement. You will need to check and/or adjust the alignment. Replacement of steering or suspension components will almost always require adjustments to the alignment.

Replacing the Steering Rack



For replacing the steering rack and pinion, you will need a hammer, pry bar, ratchet with 16mm socket, 16mm wrench, 13mm wrench, flat head screwdriver, 19mm wrench and channel lock style pliers. It is helpful to have a punch or center punch to align the steering rack holes to the frame mounting holes.

With your pliers, you will remove the cotter pins from the outer tie rod end castle nuts where the tie rod ends join to the spindles.



Use the 19mm wrench to loosen the castle nuts from the tie rod ends until they are only held on by a few threads.

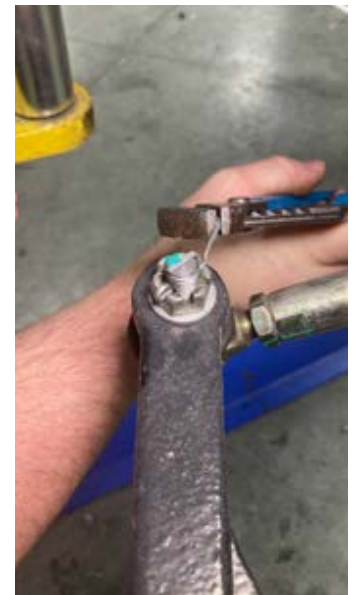

Tap the steering knuckle with a hammer, until the tie rod tapered shaft comes loose from its bore. You may need to pry down on the tie rod end while tapping, to make sure the tapered shaft has come loose.





With the 13mm wrench, loosen and remove the intermediate shaft pinch bolt. Use the pry bar to pry upward on the pinch clamp. You are now ready to unbolt the steering rack from its frame mount.

With the 16mm wrench and 16mm socket and ratchet, you will remove the 3 steering rack mounting bolts where they connect the rack to the frame.

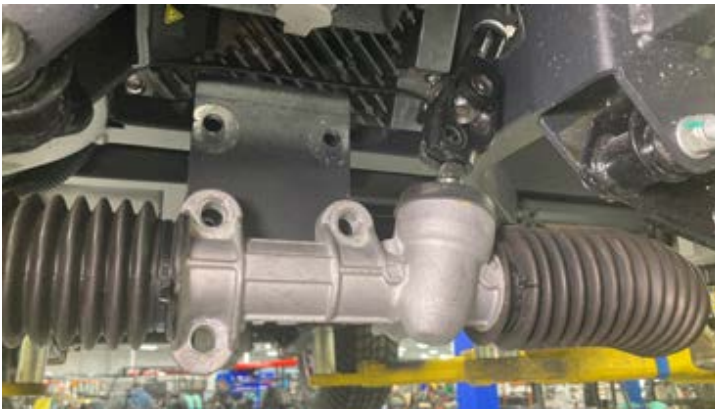

Once you have the three rack mounting bolts removed, the steering rack will be able to hang down, ready for removal.

Push upward on the intermediate shaft pinch collar to let the steering rack drop down. Do not let the intermediate shaft turn, when removing it.

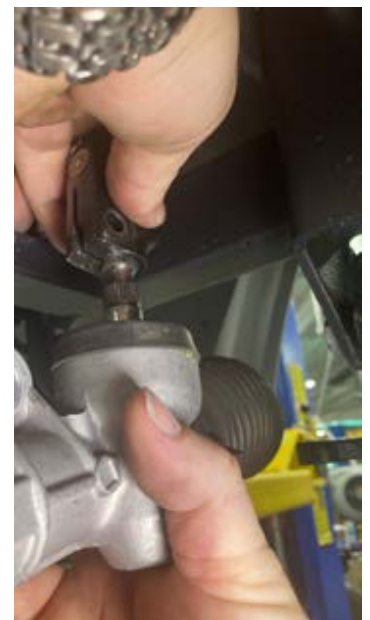



With the wheels pointed straight forward, and the intermediate shaft in the straight forward orientation, set the new steering rack with the outer tie rod ends equidistant from the center of the steering rack.



Insert one tie rod end into the steering knuckle. Install the castle nut to keep the tapered shaft from falling out while you continue to work. Repeat this step for the other side of the vehicle.

Pushing upward on the steering rack will align the frame mounting bolt holes. The steering rack will be under a great deal of tension when raised. So you may need to use a center punch to insert into one of the holes and pry the steering rack upward, to align the holes enough to install one of the bolts.



Install the intermediate shaft pinch collar onto the steering rack input shaft. Make very sure the machined groove of the input shaft is lined up with the pinch collar pinch bolt hole. Be sure to install the pinch bolt into the collar so that the threads finish in the collar threads. If they start in the threads immediately, you will need to flip the bolt around to the other side.



Replacing the Front Spindle

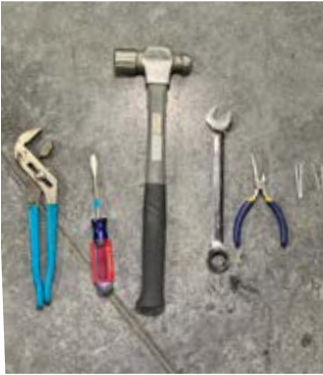

To remove the spindle, you will need a pair of channel lock style pliers, a flat head screwdriver, a hammer, a 19mm wrench, a pair of needle nose pliers or diagonal cutters, and some cotter pins. You will replace all cotter pins with new ones during reassembly.

To begin disassembly, use a flat head screwdriver and a hammer to remove the wheel bearing dust cap. Be sure the rubber O-ring is still attached to the dust cap when removed.



To begin disassembly, use a flat head screwdriver and a hammer to remove the



Using the needle nose pliers or diagonal cutters, you will remove the cotter pin that retains the wheel bearing castle nut. You will replace all cotter pins during reassembly.

Using the channel lock style pliers, remove the spindle castle nut that retains the wheel bearings.





Pulling on the wheel hub will remove it from the spindle. Set the hub aside to be reinstalled later.

Use the needle nose pliers or diagonal cutters to remove the cotter pins from the upper and lower ball joint castle nuts.



A 19mm wrench will loosen and remove one ball joint nut at a time. Remove one ball joint nut, and use a hammer to free that end of the spindle from that ball joint. The ball joint nuts are held captive by clearance, until you break at least one ball joint loose from the spindle.

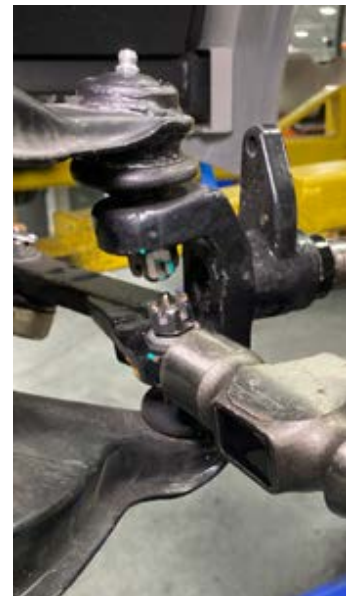

Repeat the same process for the remaining ball joint castle nut and ball joint. Both ball joints should now be free from the spindle. This only leaves the outer tie rod end to remove from the spindle.



Using the needle nose pliers or diagonal cutters, you will remove the cotter pin from the outer tie rod end castle nut. Be sure to capture and keep the flat washer under all ball joint castle nuts, along with the outer tie rod end castle nut. These will all need to be reinstalled during reassembly.

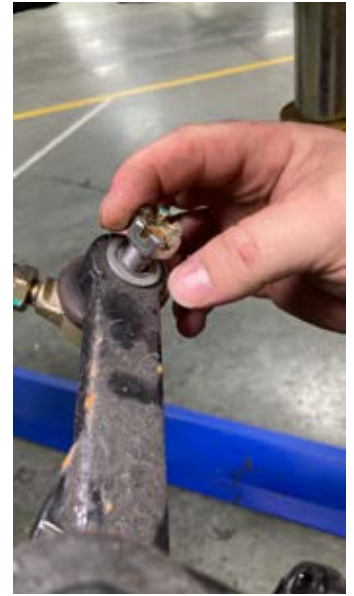

Using a hammer, tap on the steering knuckle end, where the outer tie rod end connects to the spindle. This will dislodge the outer tie rod end from the spindle.

You will now have the spindle free from the vehicle, and it can be pulled out and removed. During reassembly, be sure to reinstall flat washers underneath all the castle nuts. Be sure to install new cotter pins through all castle nuts. When tightening the large spindle nut, turn the wheel hub to ensure it is not locking down when tightening the nut. Only tighten the nut until the cotter pin hole is aligned, without binding up the wheel hub.



Replacing the Wheel Bearings



For removing the wheel bearings, you will need wheel bearing grease, a bearing packer, a hammer, dead blow hammer, flat head screwdriver, a pair of needle nose pliers or diagonal cutters, and a pair of channel lock style pliers.

Use the flat head screwdriver and hammer to knock loose the wheel bearing dust cap. Be sure that the dust cap comes away, with its sealing O-ring attached. Set this cap aside for later use.



Under the dust cap, you will find a large cotter pin. Using a pair of pliers, remove and discard the cotter pin.



Remove the large spindle nut, using the channel lock style pliers. Set this nut aside for later use.





You can now pull on the wheel hub to slide it off the spindle. Use a clean shop rag to clean all the wheel bearing grease from the spindle.

Using the flat head screwdriver, you will remove the grease seal from the rear of the wheel hub. This will allow the inner wheel bearing to be removed.



Using either a manual or pneumatic wheel bearing packer, fill each new bearing with new clean grease.



Install the new inner wheel bearing into the hub, followed by a new wheel hub grease seal. Seat the seal into its bore, using a dead blow hammer.

Install the wheel hub onto the spindle, followed with a new outer wheel bearing. Install the large spindle nut. When tightening the large spindle nut, turn the wheel hub to ensure it is not locking down when tightening the nut. Only tighten the nut until the cotter pin hole is aligned, without binding up the wheel hub. Install a new cotter pin, followed by the dust cap.



Drivetrain

The Sirius drivetrain uses a differential to transmit the motor's output to two axles. The axles are not equal length, due to the position of the motor in the vehicle. But the axles do remove and install the same way.

Depending on whether the vehicle has manual or hydraulic brakes, there are several differences in the associated parts. The axle tubes, and backing plates are just some of these differences.

The replacement of the rear end parts, is relatively straightforward, as long as you have the right tools. We've listed the necessary tools in each section, so you will know ahead of time, what you will need.

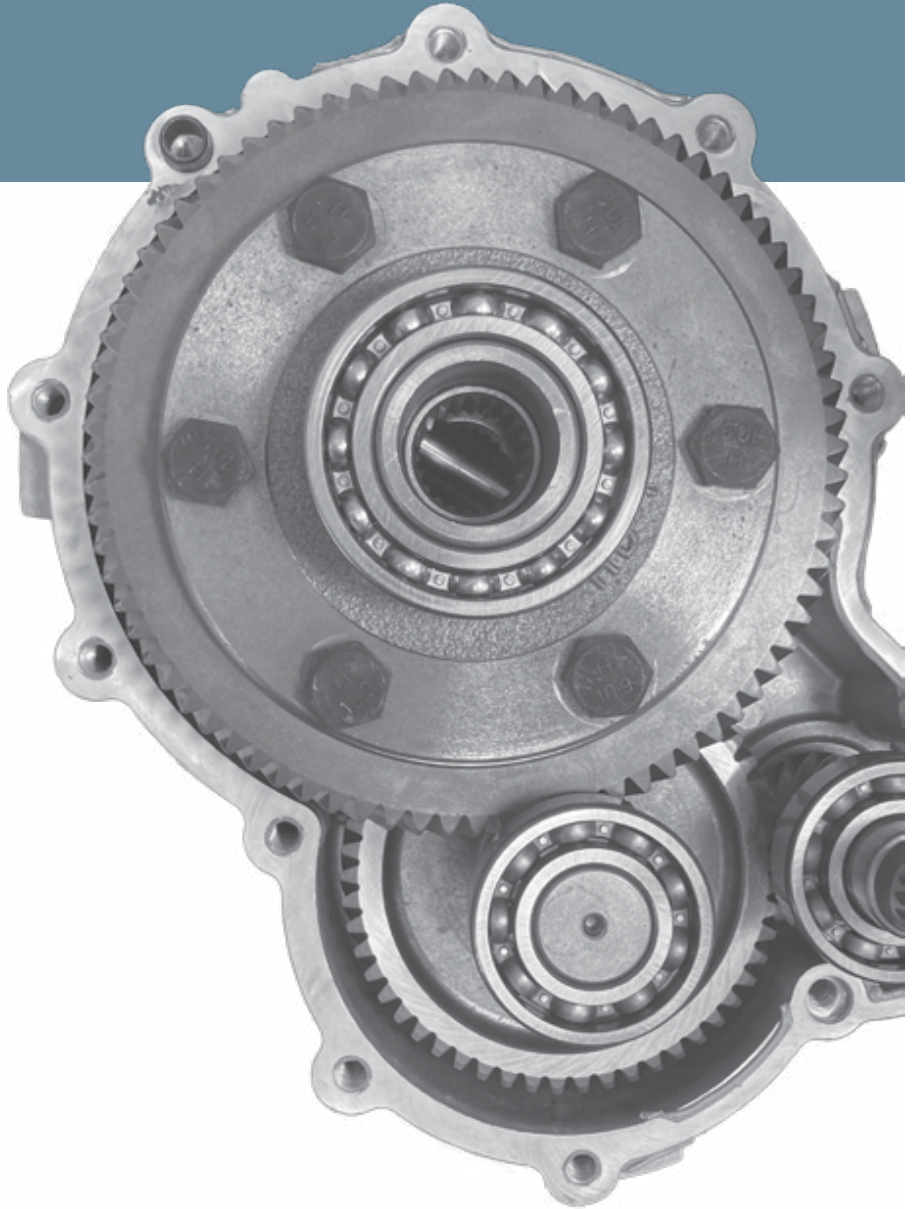

Replacing the 2P Throttle Pedal	295
Replacing the Axle	297
Replacing a Wheel Lug Stud	298
Replacing the Differential	260
Replacing the Rear End Assembly	263

Replacing the 2P Throttle Pedal



For replacing the two passenger throttle pedal, you will need a ratchet, extension, flat head screwdriver, Phillips screwdriver, pair of small cutters, and a 4mm Allen socket.



You will also need some small pick tools, and a small Phillips screwdriver.



To begin, you will use the small pick tools to pick out and remove the hot glue sealer from the brake pedal assembly trim surround tabs. These tabs extend down through the floor, from the trim surround.



There are three tabs, each with its own tiny Phillips screw. These tabs are all in-line with each other, along the front edge of the pedal assembly. One of these screws is hidden, at the very corner of the throttle pedal. Remove these three screws, to allow the tabs to be pushed back so the trim surround can be removed.



From the top, you will be able to use a flat head screwdriver to pry upward on the trim surround. You may need an assistant to pry on the tabs from below, to release the trim.



You will use a Phillips screwdriver to remove the retaining screws from the throttle sensor. Remove the sensor screws and let the sensor hang down by its harness.



Using the ratchet, extension and 4mm Allen socket, you will remove the four Allen bolts that hold the throttle pedal in place.



When you lower the throttle pedal, you must be sure to capture and save the brake pedal spacer. This will need to go back between the two pedals later, facing the same direction.



You are now ready to pull downward on the throttle pedal, and remove it from the vehicle. The steps for installing are the reverse of removal. Be sure to install the brake pedal spacer between the two pedals, or the parking brake will not operate properly.

Replacing the Axle



For removing the rear axle, you will need an impact with a wheel nut socket, slide hammer with a hub puller adapter, hammer, 13mm wrench, 13mm socket, extension and ratchet, needle nose pliers, 90° snap ring pliers, a flat head screwdriver and a small hooked pick.

A lot of these tools will be used for removing the rear brake shoes. Refer to the brake shoe removal process, before removing the axle. Removing the axle is also part of the next section, Replacing the Differential.

After the brake drums and brake shoes have been removed, you will use the 90° snap ring pliers to remove the snap ring that retains the rear axle. The snap ring is in the end of the axle tube and directly behind the axle hub. Remove this snap ring from its groove, and let it hang on the axle.

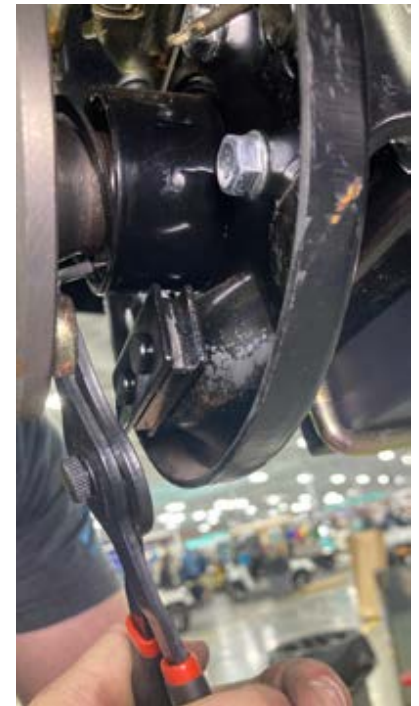

Attach the slide hammer to the lug studs, using two lug nuts. Use the slide hammer to pull outward on the axle shaft. Carefully slide the axle out of the axle tube, so as not to damage the axle tube seal. Install the new axle in the reverse order. You will need to transfer the large retaining snap ring to the new axle before installation. Use the hammer to “seat” the axle into the differential, just until the snap ring will snap into its groove in the axle tube.

Replacing a Rear Wheel Lug Stud



To replace the rear lug stud, you will need a hammer, pair of needle nose pliers, some large flat washers that fit around the lug stud and its unthreaded shoulder, a ratchet with a 19mm socket, and a non-acorn style lug nut.



Removing the lug stud requires removing the springs from one of the brake shoes, preferably the rearward shoe.



Use a hammer to knock the lug stud through the axle flange.



Apply grease, such as wheel bearing grease between the washers, and on the lug stud threads. This will prevent the threads galling up when tension is applied.



Install the lug nut so that the flat side faces the washers. Use the 19mm socket and ratchet to pull the lug stud through the flange and washers until the stud bottoms out against the back of the axle flange. Once this is complete, you will remove the lug nut and washers. Wipe any excess grease from the lug stud threads. Reinstall the brake shoe and its springs, brake drum and wheel.

Replacing the Differential

The tools needed to replace the differential are:

- Needle nose pliers
- Slide hammer with axle puller adapter
- Dead blow hammer
- 3/8" Impact gun or 1/4" impact with 3/8" adapter
- 13mm 3/8" drive deep socket
- 13mm shallow socket
- 90° snap ring pliers
- 3/8" ratchet
- 13mm wrench
- Work light
- 3/8" long breaker bar or cheater pipe for ratchet



Begin by removing the differential drain plug and draining the differential fluid.

Remove the rear end assembly and transfer to a sturdy cart or pallet. You will need to have a way to strap or secure the rear end assembly when removing the differential tube bolts. So it will be helpful to have a plan ahead of time, for where that strap will attach.

Remove the brake drums. Once they are removed, use needle nose pliers to remove the springs that connect the brake shoes to each other.



Remove the brake shoe retaining springs and pins. This will let the brake shoes loose from the backing plate.





Using the 90° snap ring pliers, set to compress the spring, remove the snap ring from its groove where the axle goes into the axle tube. This will allow the axle to be removed.

Attach the slide hammer with the axle puller adapter, to the lug studs and temporarily install 3 lug nuts. Use the slide hammer to pull the axle shaft. Remove the slide hammer for use on the opposite side of the rear end. Remove the axle from the rear end and set aside.



Using the impact with a deep 13mm 3/8" drive socket and 13mm wrench, remove the bolts that secure the brake backing plate. NOTE: the orientation of both the axle tube where it mounts to the differential, and the bracket that holds the brake cable. These will need to go back in the same orientation later. Remove the backing plate.



Now attach a ratcheting strap to the pallet or table you are working on. Tighten the strap so that the rear end isn't able to rotate, while you are removing the differential bolts.



At this point, you will use either a 3/8" breaker bar, or a cheater pipe with the 3/8" ratchet and shallow 13mm socket to break the differential bolts loose. These bolts are very tight, with red Loctite and sealant on them. Break the bolts loose initially, and then downsize to just the socket/ratchet combo or wrench to remove them completely.



Using a dead blow hammer, tap downward on each axle tube to break it free from the sealant that is holding it to the differential. At this point, you are ready to attach all the parts to the new differential assembly. Use gray sealant when mating the axle tubes to the new differential, and red Loctite on the axle tube attaching bolts.

The rest of the assembly is the reverse of the disassembly.

Replacing the Rear End Assembly



Rear end replacement will require a 4mm Allen socket, 14mm deep socket, 14mm wrench, 16mm wrench, small flat head screwdriver, needle nose pliers, high temp grease and an impact wrench with wheel nut socket. **Disconnect the battery before beginning this repair!**

If you are using an overhead vehicle lift, you will need to have a dead man stand, for safety. If you are working on the ground, you will need a jack and jack stands. The jack stands will need to go under the vehicle, with the jack being able to lower the rear end down from under the vehicle.



Place the dead man stand or jack under the center of the rear end assembly. This will be used to lower the whole assembly down, once all the mounting bolts are removed.

Using the 14mm and 16mm wrenches, you will loosen and remove the lower shock mounting bolts. Set these bolts and nuts aside for later.





Remove the cotter pins from the brake cable lever pins. Discard these cotter pins. They will be replaced upon reassembly.



Disconnect both brake cables from their brackets on the backs of the backing plates.



Lower the rear end assembly down slowly, while observing the tension on the wiring above it. Do not allow the tension to become too great, on the wiring. Only lower the rear end enough, to be able to reach the motor lead nuts with a ratchet.

With a ratchet and 14mm socket, remove the motor lead nuts. Capture and keep these nuts to the side, for reinstallation later.

Disconnect the encoder connector, and the motor temperature sensor connector. The rear end can now be lowered more, so that the motor can be removed from the rear end.





Using a ratchet with 4mm Allen socket, remove the 5 motor mounting bolts that hold the motor to the rear end assembly.

Carefully grasping the motor, you will slide it off the rear end input shaft. Bring the motor down and out of the vehicle. Set the motor aside for reinstallation later.



With the 14mm deep socket on a ratchet, you will remove the U-bolt nuts. There are eight bolts in all. You will replace the U-bolts, along with new U-bolt nuts. Once the U-bolts have been removed, you the rear end will be free from the vehicle.

You may want to have an assistant to help lift the rear end assembly out of the vehicle. But it can be done by one person, carefully.

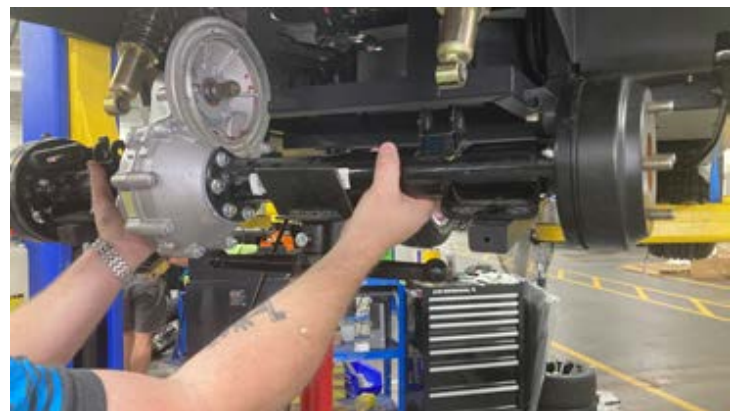



Apply a small dab of high temp grease to the input shaft splines on the rear end assembly.



Apply a small dab of high temp grease to the splines of the motor shaft also.



Lift the rear end assembly onto the dead man stand, and position the trailing arms under the rear end weldment pads.



BE SURE to align the center pin on each weldment pad, with their corresponding center pin hole in the trailing arms. The rear end will not be properly aligned to the vehicle if these pins are not lined up in their holes. Be sure that the center pins don't fall out of the holes, as you install and tighten the U-bolt nuts.

Reverse the remaining steps to complete the installation. Be sure to reconnect the battery once the vehicle has been returned to the ground.

Body Electrical

The Sirius electrical system is dual sided, consisting of the battery voltage side, and an accessory side that runs on 12V. There is a converter that reduces the full battery voltage, so it can be used by the accessories. Sometimes this converter is called the reducer.

But because there are two voltage systems at work, there are two separate wiring harnesses needed. Each accessory circuit is protected by its own fuse, along with overall protections that protect the whole vehicle.

In this section, we'll look at the accessory side of the vehicle.

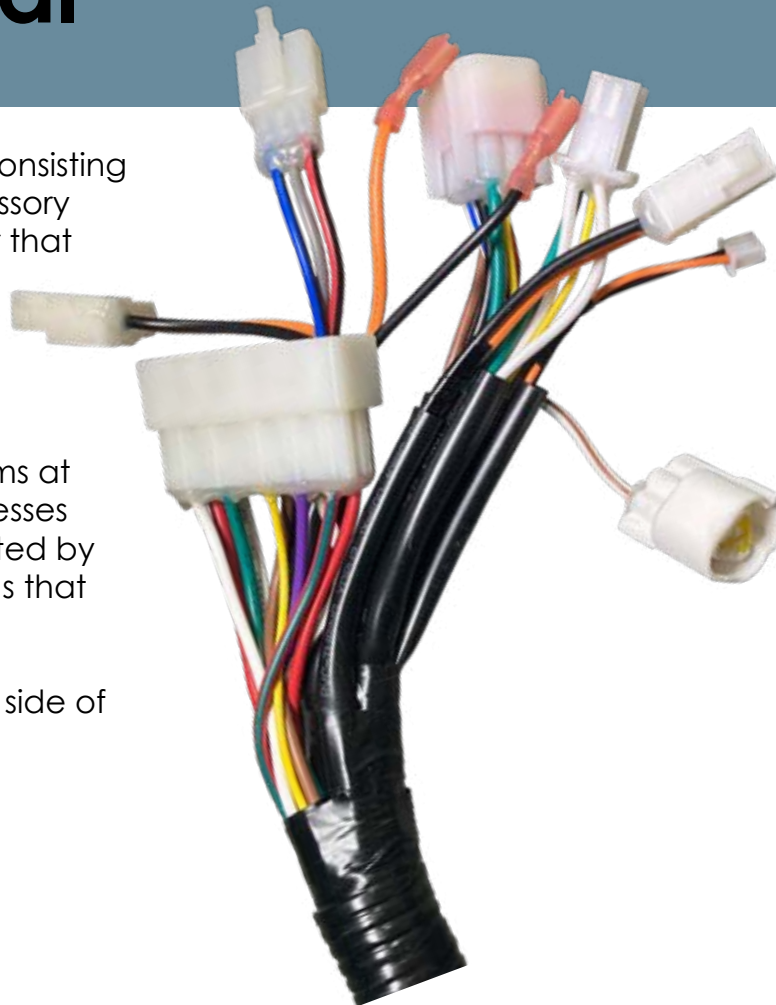

Sirius Dash Lights	308
Testing the Combination Switch	310
Cruise Control System	319
Replacing the Turn Signal Flasher	322
Replacing the Combination Switch	326
Replacing the Key Switch	332
Replacing the Horn	334
Replacing the Reverse Beeper	335
Replacing the 12V Outlet	337
Replacing the High Low Switch	339
Replacing the Fwd/Rev Switch	341
Replacing the USB Charging Port	343
Replacing the Hood Release Switch	345
Replacing the Hazard Light Switch	347

Dash Lights

The Sirius vehicle dash has two interior dash lights, one on either side. These lights feature a power button switch in the middle, under the red power symbol. These light are mounted using adhesive backing, and are thereby relatively easy to replace.



To begin replacing the dash light, you will need to gently pry the light away from the dash, to remove. You will also need to pull straight up on the center console cupholder, to remove it. This will allow access to the wiring connectors below.



Under the center dash cupholder you will find a gray and red ribbon cable, with a black connector, for each of the dash lights. Disconnect the cable that leads to the light being replaced. **BE SURE TO tape or connect a piece of string or wire to the loose end of the cable before pulling it through the dash.**



You will need this cord or wire in order to fish the new ribbon cable through the small dash holes.

Once your wires are run through the dash, you will use the self-adhesive backing to attach the new light to it's dash location.

Testing the Combination Switch

With the Sirius wiring diagram, you will be provided with all the wire colors and connections to all the components. But here, we'll take a closer look at the combination switch and its wiring. We've pinned out all the connections, with how you should have continuity in each selection of the switch. For continuity testing, the switch must be disconnected. This diagram is facing the switch harness.

For the headlights and running lights, you will have continuity between these two terminals. This will be between the Green/White wire and Green/Blue wire.

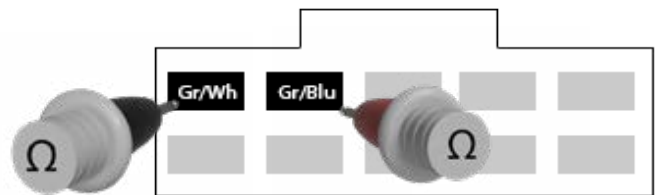

For the highbeam flash-to-pass you will have continuity between these two terminals. This will be between the Red wire and Red/Yellow wire. For this test, you will need to pull the stalk forward and hold due to the spring tension.

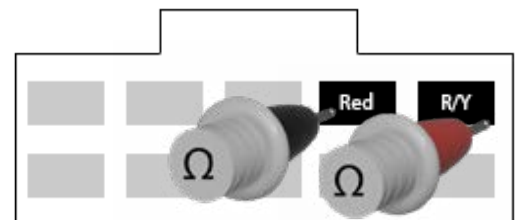

For the highbeams you will have continuity between these two terminals. This will be between the Red/Blue wire and Red wire. For this test, you will need to push the stalk back, so that it clicks into position.

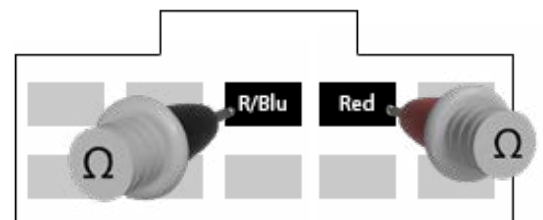

For the horn you will have continuity between these two terminals. This will be between the Red/Black wire and Black wire. For this test, you will need to push the horn button in, on the end of the stalk. This switch will only remain closed when pressing the switch.

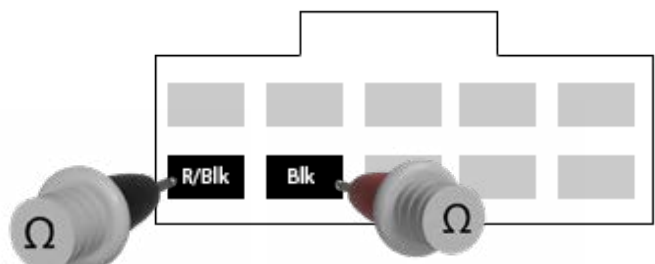

For the left turn signal you will have continuity between these two terminals. This will be between the Green/Purple wire and Green wire. For this test, you will need to push the stalk down, so that it clicks into position.

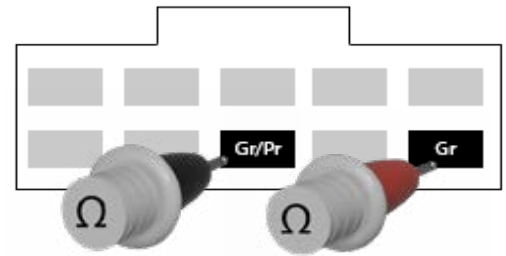

For the right turn signal you will have continuity between these two terminals. This will be between the Green/Black wire and Green wire. For this test, you will need to push the stalk up, so that it clicks into position.

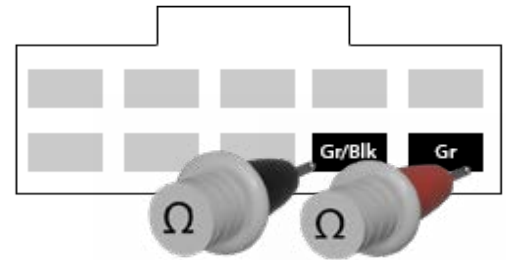

You will notice that the turn signals share the green wire. You will also notice that almost all the wires are either green or red, with their prospective stripes. So it's very important to know where your continuity will be, because it can be rather confusing if not.

Headlight Testing

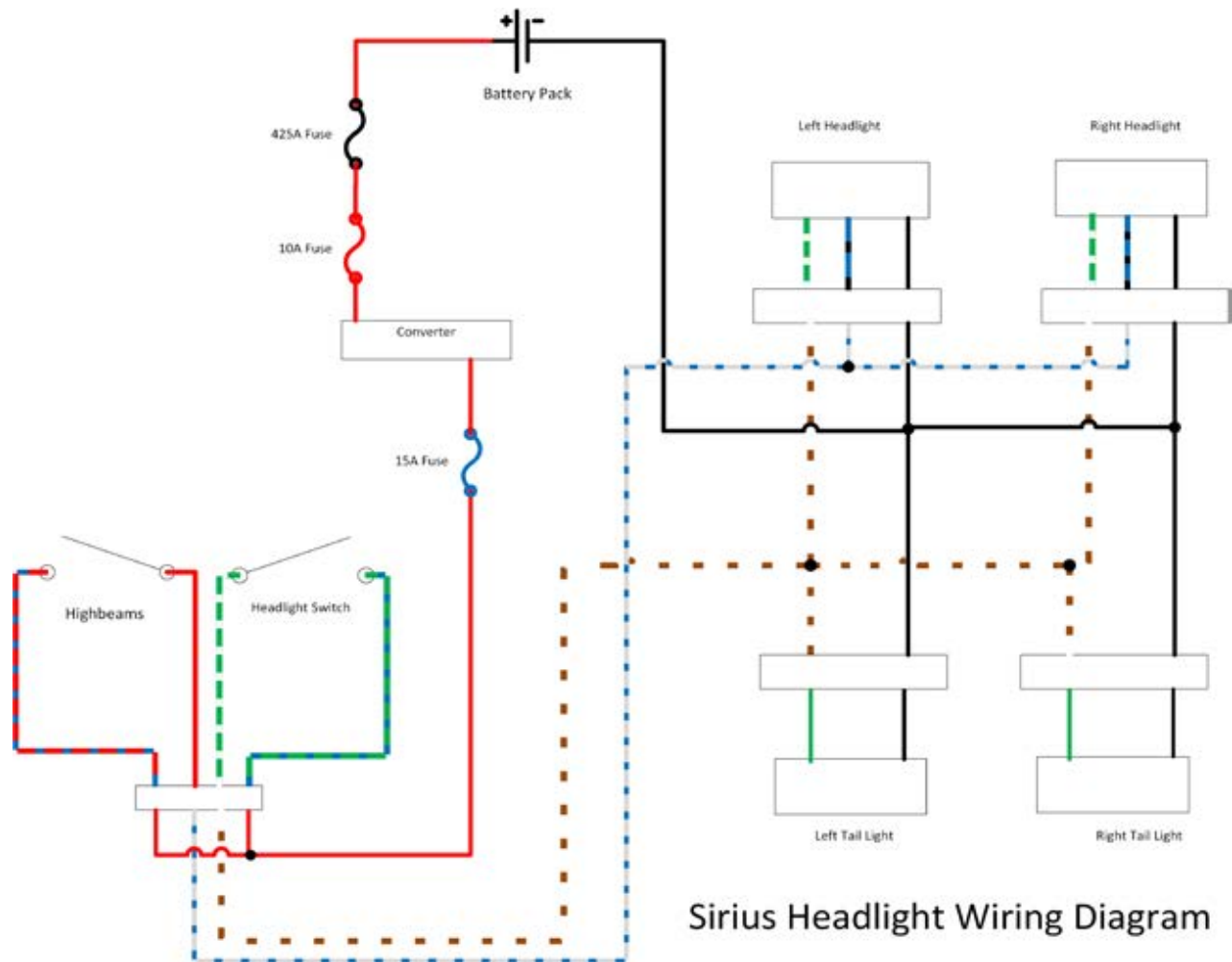

Sirius Headlight Wiring Diagram

Concern	Check
Headlights and Highbeams inoperative	Check power and ground since they are common to both. Check fuses if there is no power at the switches.
Headlights turn off when driving	Check voltage stays consistent on supply side of converter, and then on 12V output side of converter.
One headlight or one tail light inoperative	Check power and ground to that bulb, and resistance through the bulb. Visual inspection alone may not show the problem.
Headlights OR Highbeams inoperative	Check for continuity through the affected switch, using the continuity diagram on page 80 (Testing Sirius Combination Switch).

Turn Signal Testing

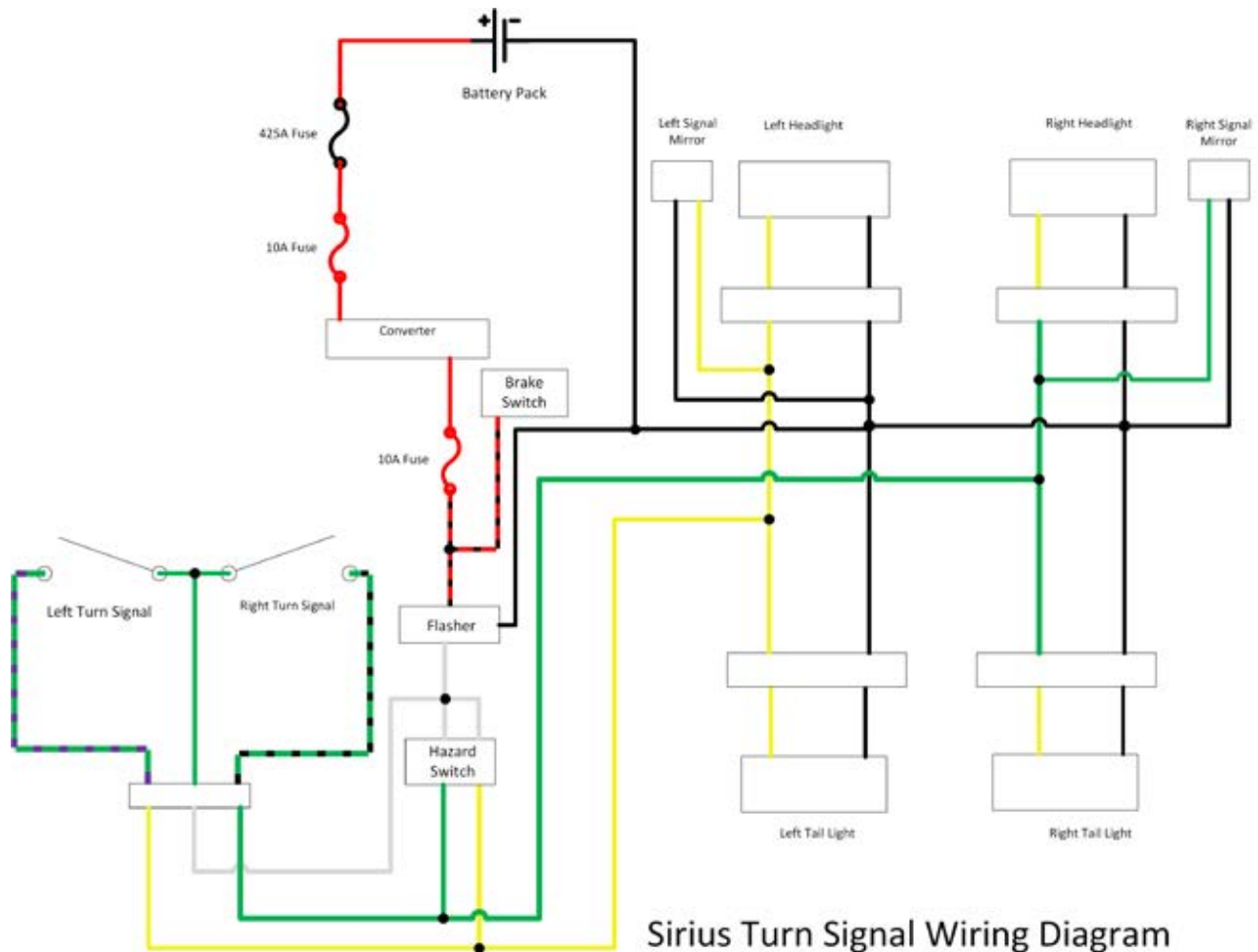

Sirius Turn Signal Wiring Diagram

Concern	Check
Turn signals inoperative	Check power and ground since they are common to both. Check fuses if there is no power at the switches.
Turn signal mirror inoperative	Check for proper ground to affected mirror and flash signal to mirror. It is very helpful to have a voltmeter with a MIN/MAX button, for this testing.
Turn signals do not self-cancel	Check turn signal self-canceling tabs, inside the switch. Threaded self-cancel pins can damage the plastic tabs on the switch.
Turn signal on one side inoperative	Check that the power and ground signals are reaching the affected side of the vehicle.
Turn signals don't flash	Check turn signal flasher for interruption of signal, for flashing to take place.

Turn Signals Inoperative

When diagnosing turn signal issues on the Sirius vehicle, especially ones that have a glass, DOT windshield you may find an issue where one or both of the side mirror turn signals are inoperative. They may work intermittently when the wires are wiggled around.



This concern may be due to the windshield mounting screws piercing the wires leading to the mirrors, since they are run inside the front roof supports.



When installing a new side mirror, be sure to use a fish wire, and tape it to the old mirror wiring harness. This will follow the old harness out of the roof support, and then you can tape the harness of the new mirror to that same fish wire. This will save you lots of time and trouble, when installing the new mirrors.



Diagnose Sirius Brake Lights

The Sirius brake light switch gets its power from the same fuse as the flasher/hazard lights. This fuse is the red 10 amp fuse. So to begin, you can verify if the flasher and hazard lights operate. Since they share the fuse with the brake lights, the brake light switch should have power available if the flasher/hazard lights are working. The power travels to the brake switch, via a red/black wire. The brake pedal houses the brake switch, underneath the black pedal pad.



The brake pedal switch is pressure activated. To test this switch, you can disconnect the white, two wire connector, where it connects to the cart's main harness. With a voltmeter, set to continuity, you will check across the terminals for continuity. There should be continuity with the pedal pressed, and an open circuit with the pedal released.

If there is no continuity across the switch, the switch will need to be replaced. The switch part number is 2SW612. If there is continuity across the brake pedal switch, set your voltmeter to DC volts. You will need to check across the main harness side of the brake switch connector next. With the key turned on, you should see 12V across this connector.



If all the other checks are good, you should have power going to the brake lights themselves. At the tail light assembly, you will find the gray or gray/red wire across from the black wire in the vehicle side of the connector. Disconnect the harness from the tail light and check from the gray wire to the black wire, with the brake pedal pressed.



12V should now be available, when measured across the two middle terminals. If in any of these tests, you do not see 12V, you will need to check and see if the power is the issue, or the ground is the issue.

To test a ground circuit, connect your red voltmeter lead to your battery main positive. Connect your black lead to the ground wire in question. You should see battery voltage on your meter.

To test a power circuit, you will do the reverse. Place your black lead to the battery negative, and the red lead to the power wire in question. You should see battery voltage, if the circuit is good.

When testing voltage across the same connector, you should see 12V when testing on the accessory harness side of the cart. But you will see battery pack voltage when using the battery as the power source. When testing on the accessory harness side, the converter becomes the power source, so this is why you will see 12V after the converter.

If faulty power or ground is found, trace and repair the wiring. If good power and ground are both supplied to the brake lights, but they are still inoperative, replace with a good tail light assembly.

Testing 4P Parking Brake Switch

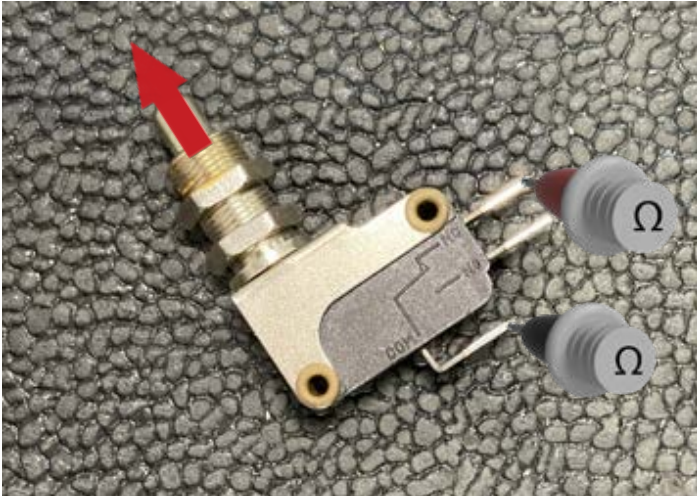

There should be continuity between these terminals when released.



There should be continuity between these terminals when depressed.

To test a switch out of the vehicle, you will find the continuity between the terminals as shown above. When released, there is continuity between COM and NC (Normally closed). When depressed, there is continuity between COM and NO (Normally open).



When testing in the vehicle with key on, and switch depressed, you will measure voltage between COM and NO to find 12V. With leads reversed, you will find -12V. Voltage will not be present when released.



With the key on, test between COM and NC, with switch released, to find 12V. Voltage will not be present when depressed.

Brake Lights Stay On



There are two places that have been found to cause the brake lights to be on constantly. The first one is the two pin connector being plugged in, along the rear upper frame cross member. There are two unplugged, white 2-pin connectors at this frame cross member. But these are not intended to be plugged into each other. If they are connected, it will supply constant power to the brake lights. This will keep the brake lights lit any time the key is on.



The other issue that has been found to keep the brake lights lit constantly, until the brake pedal is depressed, is a normally closed brake light switch in place of a normally open switch. In this situation, the brake lights operated directly opposite of the expected operation. When the pedal was released, the lights were on. With the pedal depressed, it would turn the lights off. To check this switch, check for continuity when pressing the pedal. In normal operation, there should be continuity when the pedal is pressed and none when the pedal is released.

Cruise Control

New in 2024, the Sirius is available with cruise control. This system is designed to be set above or equal to 8mph, and is only available with Curtis controllers. The system has an additional brake switch for disengaging the system when driving.

The connectors for the set, and ON/OFF buttons are exactly the same, so they can be interchanged when connected into the vehicle. So if your cruise isn't working, it can be that the connectors are reversed.

If you need to test to make sure they aren't reverse, you will remove the center dash cupholder, and locate the connectors that are going to the two cruise switches. Reverse the two connectors and retest. The controllers are programmed to work with the correct signals already. So if they don't get the proper signal, the cruise will just not respond.



2024 Star Sirius Add-on Cruise Control Wiring Harness

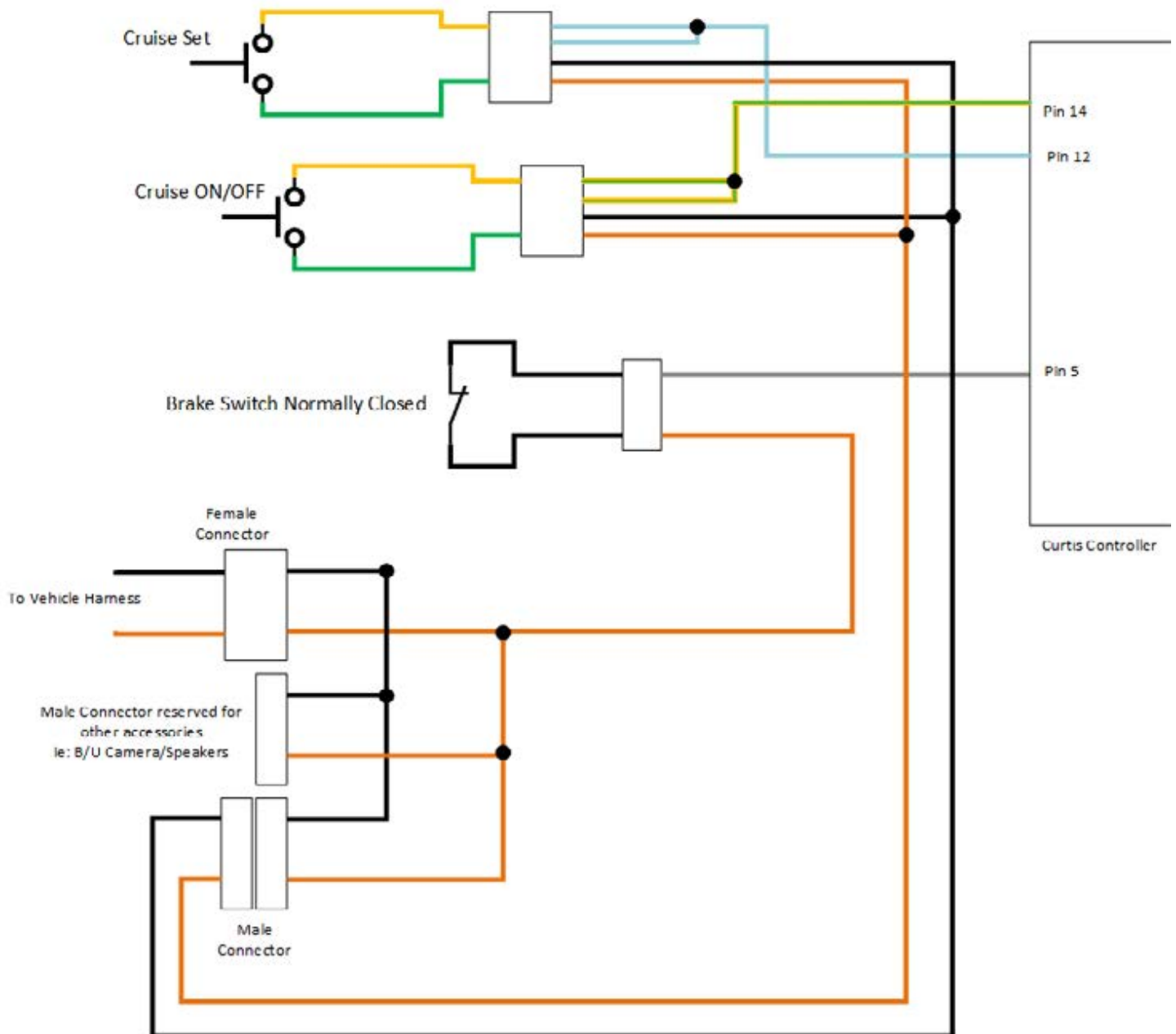

Notes:

Cruise control system is made to set above or equal to 8mph.

At this time, 6/22/23, this system is only applicable to vehicles with Curtis controllers. These controllers must be reprogrammed, to work with the cruise control system.



In normal operation, the Cruise ON/OFF switch will remain depressed while the system is in use. The Cruise Set button is only a momentary switch, and does not stay pressed in. The brake pedal has been fitted with an additional brake switch that breaks the cruise signal to the controller.



When the Cruise ON/OFF switch is pressed, you will see switch 6 change from off to on, indicating that the system has been activated. The controller will now be looking for the SET button to confirm the speed request, and set the speed as long as the vehicle is traveling above 8mph.

Replacing Turn Signal Flasher



To replace the turn signal flasher unit, you will need to use an 8mm socket or nut driver to remove the retaining screw. The same screw that holds the flasher is the same one that holds the horn. They are located right behind and above the right front wheel.

Using an 8mm socket, remove the retaining screw from the horn and flasher module. This will allow the flasher and horn to hang down by the wiring.



Disconnect the wiring connector from the flasher module. Note the orientation of the module to the connector. There are three spade terminals inside the connector. And the flasher is made to plug into those three terminals.



Once the flasher is replaced, it will look like this, ready for securing to the frame member.



Using the securing screw, position the flasher module on top of the horn tab and secure both to the frame member with the self-tapping screw.

Replacing the Turn Signal Mirror

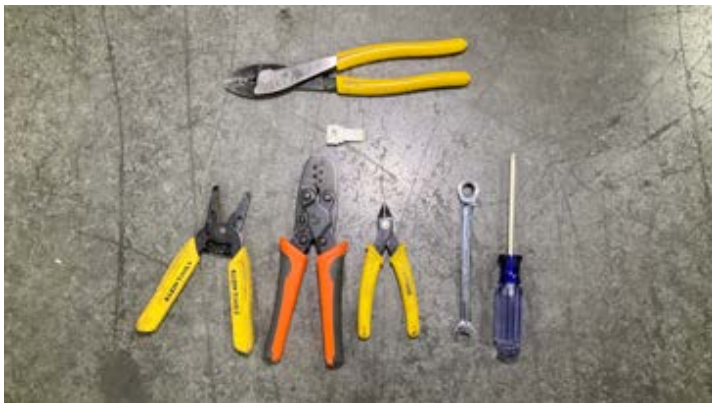

For replacing the side turn signal mirror, you will need a wire cutter, wire stripper, wire terminal crimper, small pair of snips, Phillips screwdriver, 10mm wrench, and 2 pin connector that is supplied with the replacement mirror. New terminals will be attached to the mirror wires.

To remove the side mirror, you will refer to our section on removing the windshield. Above the wheel, on the side you're replacing, you will find the mirror wiring harness with zip ties securing the harness to the vehicle. Cut and remove these zip ties.

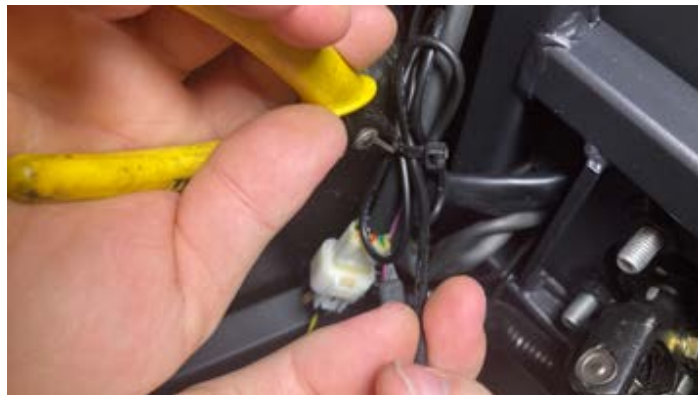

Disconnect the mirror wiring harness connector. This will be a white, two pin connector.



Using a Phillips screwdriver, and 10mm wrench, you will remove the mirror mounting screws. Capture and set aside this hardware for later reinstallation.





The mirror will be free from the roof support, and the wiring will be free, with the white connector still attached to the end. Do not pull the wiring out yet. You will need to cut the white connector from the end of the wiring. This is to allow the wiring to pass through the roof support.



Bend the cut end of the wiring harness around the end of a fish wire, and wrap them together using black electrical tape.



You will now be able to pull the mirror upward, bringing the wiring harness and fish wire up with it. This will give you a fish wire to connect to, to pull the new wiring back down through the roof support.



Attach the wiring harness, from the new mirror, to the fish wire that is now waiting inside the roof support. Pull the fish wire down through the roof support, with the taped harness attached, until it come out below the front body of the vehicle.

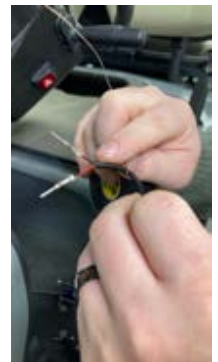

Install the wiring terminals into the two-pin white connector. Be sure to reference the polarity of the mating connector. Since the mirrors use LED lighting, they are polarity sensitive.



Reconnect the wiring harness, and secure it with zip ties. Test your mirrors for proper operation.

Replacing the Combination Switch

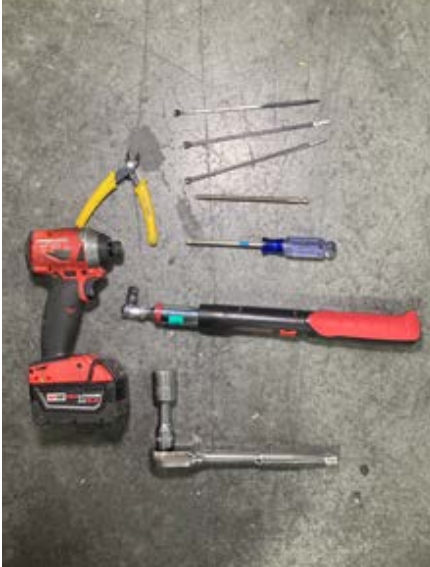

When replacing the combination switch, you will need either a powered or manual Phillips screwdriver, a pair of small snips, a torque wrench a ratchet with extension and a 24mm socket. You will also need a plastic trim removal tool to remove the center dash cupholder.



Be sure to point the wheels straight ahead so that there are no issues with the turn signal cancel pins after you are finished.



Remove the steering wheel center trim cap and set aside. You will simply pull up and away from the steering wheel to remove the trim.



Use the ratchet, extension and 24mm socket to remove the steering wheel center retaining nut. Set this nut aside for later. Pull upward on the steering wheel to remove it from the steering column. Set the steering wheel aside.

Using the trim removal tool, gently pry up on the center dash cupholder. This will give you access to the wiring connectors inside the dash.



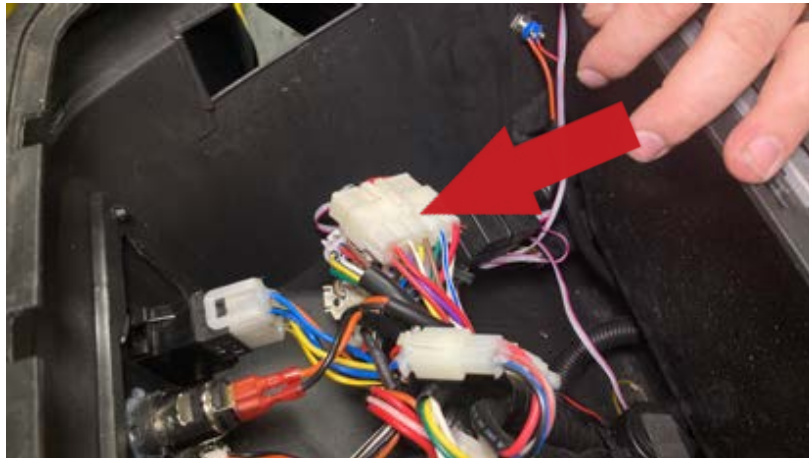

This is the connector for the combination switch. It is the largest connector in the center dash compartment.

Using the small snips, cut all the zip ties that hold the wiring harnesses together. You will be able to replace these ties once you get done replacing the switch.

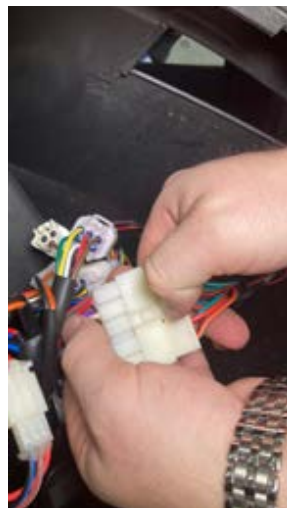
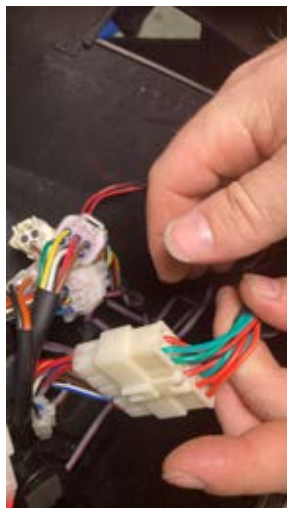
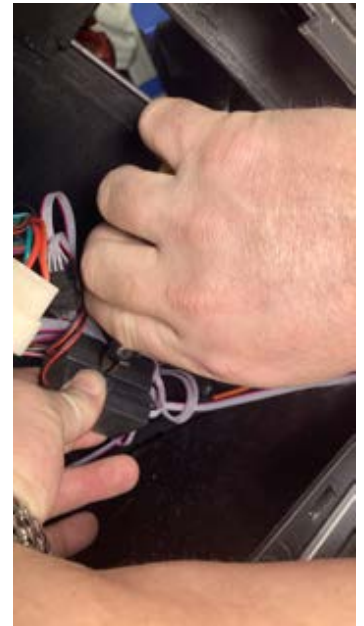

Pull the large white connector up out of the dash compartment, and press the locking push tab to release the two halves of the connector.

The male end of the connector is the end with the push tab on it. This is the end that you will begin to fish down through the dash, between the dash compartment and the front trunk compartment.

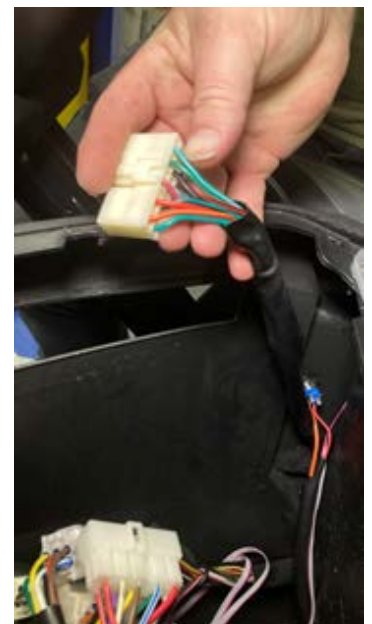



The wiring harness will pull downward, above where the steering column comes through the firewall. You will need to push from the dash area, while pulling down from the steering column base area at the same time.

You may need to pull the excess wiring harness out of your way as you work.



Along the side of the steering column center tube, you will see a black plastic trim housing that hides all the steering column wiring inside. Slide this trim cover off and away from the steering column. This will expose the wiring harness where it runs up alongside the column tube.

At this time, you can reach down and slide the rubber column surround up from where the column meets the floor.



The wiring harness should be under the vehicle now, pulled down from inside the center dash area. Now you can work the wiring harness up through the floor, until it is inside the vehicle.



Once you have all the wiring inside the vehicle, you will need to work it through the rubber boot that goes around the steering column tube. The hardest part is getting the white connector to go through this boot, so take your time.



Using the power or manual screwdriver, remove the 4 trim screws from the lower steering column cover. This will let you follow the wiring harness all the way up and into the column cover.





Set the lower column trim cover aside. You will see four Phillips screws that hold the switch to the steering column.

Removing these four screws will release the upper half of the steering column trim cover from the steering column.



After the screws are removed, you will be able to lay the top half of the steering column trim housing over onto the center dash so it is out of the way.

You will now be able to see the three Phillips screws that secure the combination switch to the steering column. The screw locations are shown here.





Use the Phillips screwdriver to remove the three screws from the combination switch.

You will now be able to remove the combination switch from the vehicle. You will reverse these steps to install the new switch. **BE SURE** that the turn signal cancel pins, on the bottom of the steering wheel adapter are oriented at the 3 o'clock and 9 o'clock positions when you reinstall it. This will make sure that the turn signals will cancel properly when the installation is complete. The wheels were centered during the first step.



Replacing the Key Switch

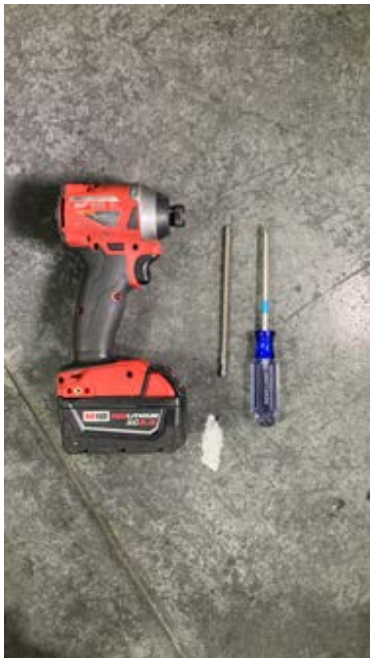

To replace the key switch, you will need either a powered or manual Phillips screwdriver.

Begin by unscrewing the bezel trim around the key switch. You will see a reddish shim piece that is behind this bezel trim. Be sure to capture and keep this shim.

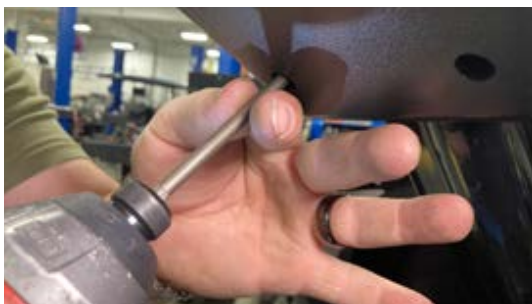

Moving to below the steering column, use the Phillips screwdriver to remove the four Phillips screws that secure the two halves of the steering column trim to each other. This will let the lower section of the trim cover hang down so you can access the inside of the cover.



Pay special attention to the routing of the key switch harness. You do not want the mounting screws to pierce through the wiring, if it gets pinched between the two halves when reassembled. **You do not want the wiring to be routed over any of the screw standoffs.**



When you have the retaining nut, and shim removed, the key switch body will be able to come out of the lower trim cover. Use the connector release tab on the white 4-pin connector to release the two sections of the connector.



You can now pull the key switch from the lower cover completely. Installation is the reverse of removal. Be very sure that the wiring is properly routed around the screw standoffs, so that they aren't pinched between the two cover halves, and aren't pierced when the screws are installed.

Replacing the Horn

When replacing the horn, you will find it behind and above the right front wheel. It is mounted to the frame member, under the tab for the flasher relay.



Using an 8mm socket or nut driver, remove the self-tapping screw that holds the flasher relay and horn to the frame member. Both the flasher and horn will be loose and able to hang by their wiring. There are two wires that attach to the horn, one purple and one black. Remove these two wires from the horn. The polarity doesn't matter on these wires. So you can connect either, to either terminal.

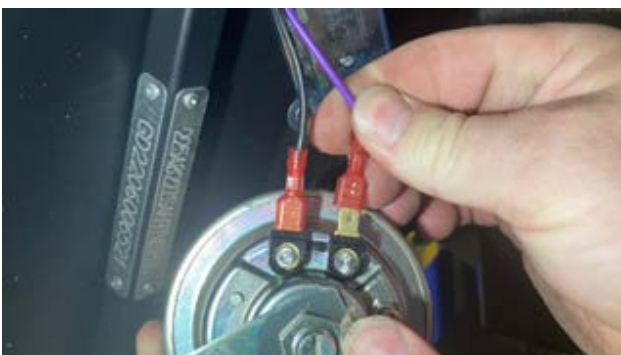

Reconnect the wires to the new horn, and using the self-tapping screw, secure the flasher tab on top of the horn tab and then all to the frame member.

Replacing the Reverse Beeper



Using a plastic trim removal tool, pry up around the center dash cupholder. Using this tool, will help to prevent cracking in the cupholder finish.



After the cupholder is removed, you will locate the round black backup beeper. It will be zip tied to the wiring harness under the cupholder.

Use a pair of small snips to cut away the zip tie that holds the beeper to the wiring harness. This will release the beeper so that it is only held by its wiring.

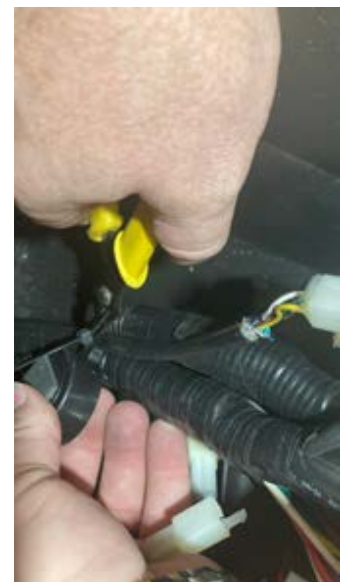

Using the same small snips, remove the glue that holds the two sections of the connector together. This will prevent the two halves of the connector from coming unplugged. Once you've got this glue out of the connector, you'll be able to disconnect the wiring.



You are now able to press down on the white plastic locking tab so the two sections can disconnect.



Replacement is simply a matter of installing the new buzzer, and reconnecting the wiring connector. Using a new zip tie, connect the buzzer to the wiring harness and trim off the excess zip tie material with the small snips.

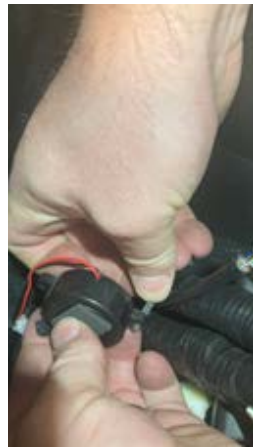

Replacing the 12V Outlet



Using a plastic trim removal tool, pry up around the center dash cupholder. Using this tool, will help to prevent cracking in the cupholder finish.

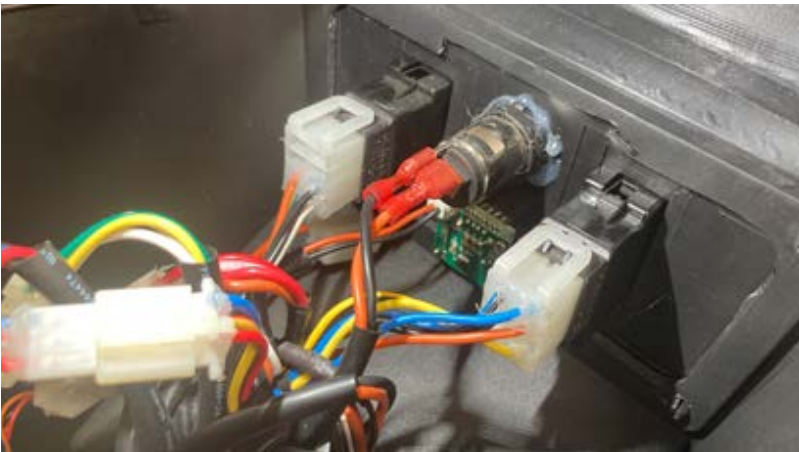

The 12V accessory outlet is located right under the center dash cupholder between the forward reverse switch and the high low switch.



You will see two slots when looking through the sides of the outlet body. There are two small black plastic locking tabs that hold the outlet in its socket.



Disconnect the two wires from the back of the outlet, with the key turned off.

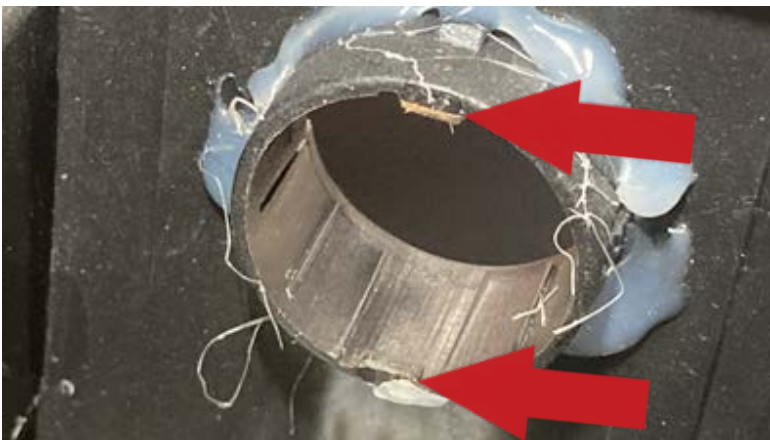

In this closeup photo, you will see the two plastic tabs. Reach into the outlet with a small screwdriver or pick tool and press outward on the tabs, while pushing forward on the outlet from its back. With each tab released from its slot, the outlet will be able to slide free.

The outlet is now free to be removed. Once the new one is slid into the opening, the retaining tabs will click into the slots on the sides of the body. This will keep the outlet from falling out when in use.



Reconnect the outlet wiring, with the black wire on the body or case of the outlet, and the orange wire going to the center terminal at the back of the outlet. This will supply power to where it is needed by the accessories that will use the outlet.

Replacing the High Low Switch



Using a plastic trim removal tool, pry up around the center dash cupholder. Using this tool, will help to prevent cracking in the cupholder finish.



The High Low switch is located on the right side of the dash, to the right of the 12V accessory outlet. Since we're looking at it from the back in the photo, it's the one on the left.



Using a knife point or pick tool, remove the glue spot that locks the switch into the dash. There is usually one of these spots on both sides of each switch.

Disconnect the wiring connector by lifting up slightly on the white locking tab. Be careful not to lift too high on this tab, so it doesn't break off. Rock the connector side to side, to release it from the switch. Once removed, you will be able to remove the switch from the dash.





You will find a small black plastic push lock tab at the top and the bottom of the switch. Press down on these tabs to release the locking feature. Once you get one of the top or bottom edges to release, you will be able to assist by pulling from the front of the switch.

Now you will be able to pull the switch from the dash. To replace, simply perform these steps in reverse.



Replacing the Fwd/Rev Switch



Using a plastic trim removal tool, pry up around the center dash cupholder. Using this tool, will help to prevent cracking in the cupholder finish.



The forward/reverse switch is located on the left side of the dash, to the left of the 12V accessory outlet. Since we're looking at it from the back in the photo, it's the one on the right.



Using a knife point or pick tool, remove the glue spot that locks the switch into the dash. There is usually one of these spots on both sides of each switch.

Disconnect the wiring connector by lifting up slightly on the white locking tab. Be careful not to lift too high on this tab, so it doesn't break off. Rock the connector side to side, to release it from the switch. Once removed, you will be able to remove the switch from the dash.





You will find a small black plastic push lock tab at the top and the bottom of the switch. Press down on these tabs to release the locking feature. Once you get one of the top or bottom edges to release, you will be able to assist by pulling from the front of the switch.

Now you will be able to pull the switch from the dash. To replace, simply perform these steps in reverse.



Replacing the USB Charging Port



Using a plastic trim removal tool, pry up around the center dash cupholder. Using this tool, will help to prevent cracking in the cupholder finish.

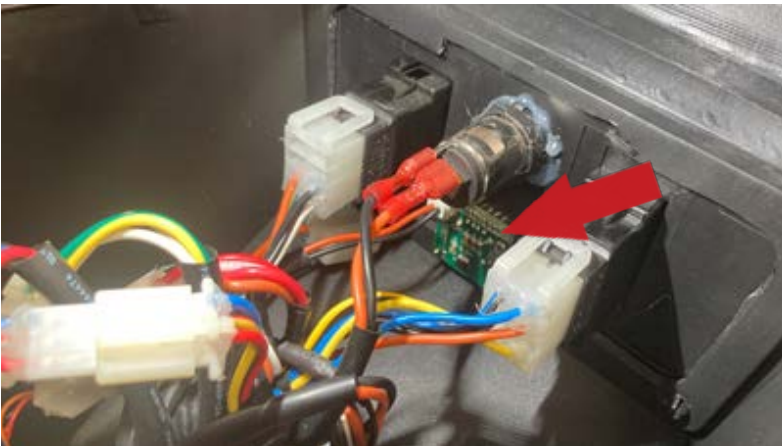

The USB charging port is located in the center of the dash, below the 12V accessory outlet. It is located below all the other switches and has its own small circuit board.



To begin removing the USB charging port, disconnect all the other switches by prying up slightly on their connector locking tabs. Don't lift up too high on the locking tabs, so they don't break off. Disconnect the two wires from the 12V accessory outlet. Disconnect the tiny white connector from the back of the USB port circuit board. You should have all the items around the USB port disconnected before you begin to remove the USB charging port circuit board.



Once you have access to the circuit board, you will see there are three very small Phillips screws that attach it to the dash. Using a small Phillips screwdriver, you will remove these three screws to allow the circuit board to release from the dash.

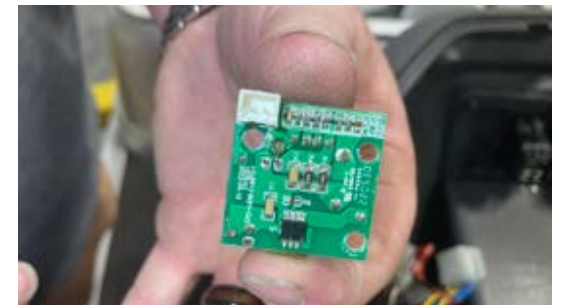

Shown is the location of the three screw mounting holes. Once these screws are removed, the circuit board will come out.

Reverse these steps in order to install the new circuit board. When reinstalling, be sure to connect the small white connector. This connector is easy to forget, and easy to disturb when reconnecting all the other switches that are located above.

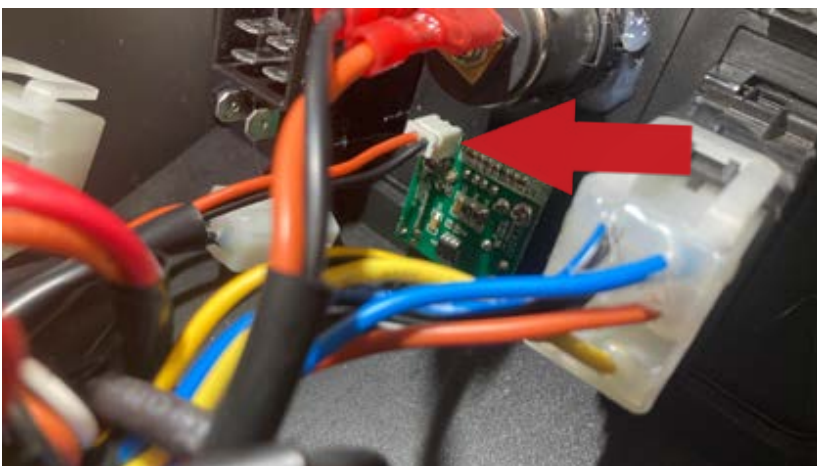

Replacing the Hood Release Switch



Using a plastic trim removal tool, pry up around the center dash cupholder. Using this tool, will help to prevent cracking in the cupholder finish.



The hood release switch button is located on the drivers side of the center dash, right beside the steering column. The button is silver in color.



Verify the key is turned to off. Using a small Phillips screwdriver, loosen the two small screws that retain the power and ground wires to the back side of the switch.



Disconnect the wires from the switch. This will allow you to loosen the retaining nut from the back of the switch button.



Set the retaining nut aside until you have installed the new switch.



Insert the new switch into the dash, and attach the retaining nut. Tighten the nut using your fingers only. Insert the wires through the holes in the switch terminals and tighten the Phillips screws to retain the wires. The process is now complete.

Replacing the Hazard Light Switch



To replace the hazard switch, you will need a Phillips screwdriver. It can be a manual or powered version.



Begin by removing the four Phillips screws from the lower steering wheel cover. This will let the lower cover come down with the key switch and hazard switch in it together.



The hazard switch has four wires that connect to its back, using spade terminal connectors. Note the position of each color of wire, so you can replace them in the right order.

Disconnect all the wires from the switch, after marking down the position of each color.





Locate and squeeze the retaining tabs on the sides of the switch. This will let the switch come out of the lower cover.



To replace, press the switch into the hole in the lower cover. The tabs will click into place, to hold the switch in its place.



Connect all four wires to the back of the switch, making sure not to push the switch back out of its hole. Once the wires are in place, you will install the four lower cover screws, to close up the steering column trim.

Replacing the Wiring Harnesses



To replace the wiring harnesses, you will need an impact wrench with a Phillips screwdriver bit, Phillips screwdriver, small pair of snips, flat head screwdriver, plastic trim pry bar, 10mm wrench, small flat head screwdriver, a 16mm socket, 8mm socket or nut driver, an extension and a ratchet.

Begin the wiring harness replacement process by disconnecting the battery, or batteries. This will make sure there is no power available to the system while you are working.



Now you will remove the windshield as shown in the windshield removal section. Follow this by removing the center dash cupholder, using the plastic trim tool. This will give access to the dash wiring connections.

Use the small snips to cut all the zip ties that secure the wiring harnesses under the cupholder. The only thing that will not be removed, from under the cupholder, is the wiring from the switches on the steering column.

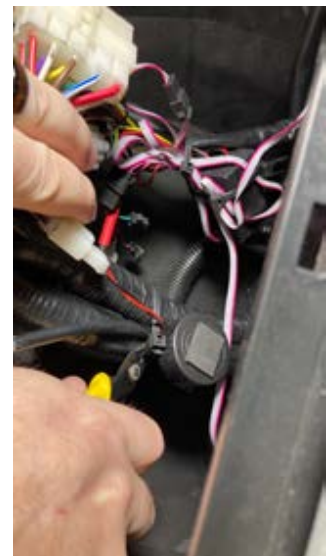

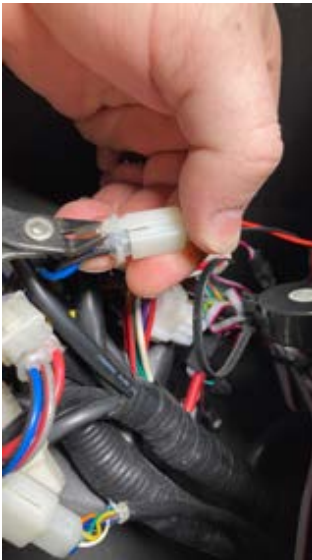

There may be times when you will need to cut and remove the hot glue from the connectors. This hot glue is to keep the release tabs from being depressed and letting the connectors come undone. Clip the hot glue and pull it out from under the release tabs.



Disconnect all the connectors inside the center of the dash. Disconnect all the connectors that attach to the harness, where they come from the steering column switches. Disconnect the wires from the electric hood release switch. Disconnect and remove the backup beeper and set it aside.



From the underside of the vehicle, you will cut the zip ties that secure the wiring harness above the throttle pedal area. Begin to pull downward on the harness, working until you pull all the dash connectors through and under the vehicle.



On the passenger side front of the vehicle, use the snips to cut all the zip ties that secure the harness that leads to the flasher relay, horn, and lights. Disconnect the harness from all the components on this side of the cart.

Also, cut the zip ties that hold the harness that leads to the hood latch actuator.



Work all the wiring through the frame members, until it's all near the foot pedal area, below the cart.



Using the Phillips screwdriver or bit, remove the screws for the motor controller cover. Pull out and remove this cover and set it aside.



Cut all the zip ties that run along the frame rail, near the controller cover.



With the 10mm wrench, disconnect the ground wire at the 'B-' terminal at the controller.



Using an 8mm wrench or socket, you will disconnect the control wires at the contactor. Disconnect the 32-pin connector from the controller also.

With a Phillips screwdriver or bit, you will remove the screws that retain the seatbelt pocket, at the back of the seat. Once this is removed, you will be able to access the wiring, where it goes over the frame at the rear of the cart.





Cut all the zip ties along the back of the frame member, and along the frame rail beside the charger and converter.

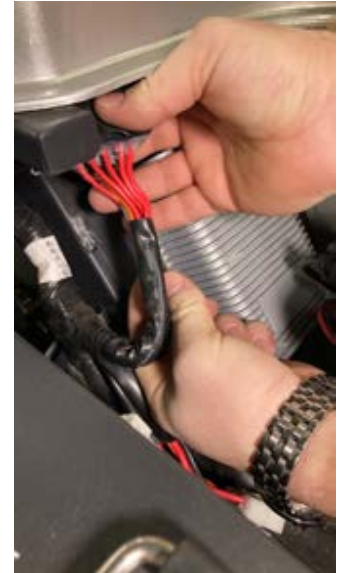

With the small flat head screwdriver, you will depress the small detent that retains the fuse block into its bracket.



With a Phillips screwdriver, and 10mm wrench, you will remove the screws and nuts that hold the charging receptacle into the body.

Once the receptacle is removed, you will disconnect the two wires from the charger interlock switch. You will then pull them out from the rubber boot that surrounds the back of the receptacle. These two wires are part of the vehicle harness, the other receptacle wires can be left alone.

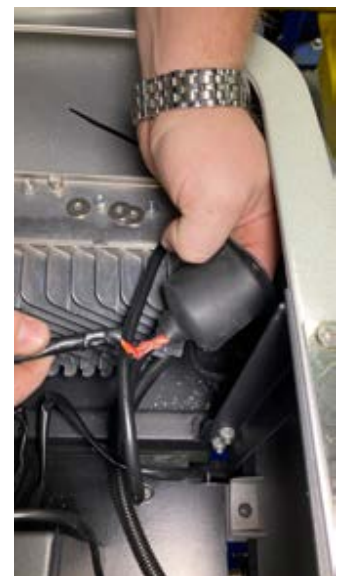



Reaching through the seatbelt opening, above the battery, disconnect the rear lighting assemblies.

With a 16mm wrench and socket with ratchet, remove the bolts that attach the battery tray to the vehicle. You will find two accessible through the seatbelt opening, and two at the front of the battery tray floor. You may need to remove the battery/batteries in order to lift the battery tray. Use an 8mm socket to remove the two battery trim cover self-tapping screws.

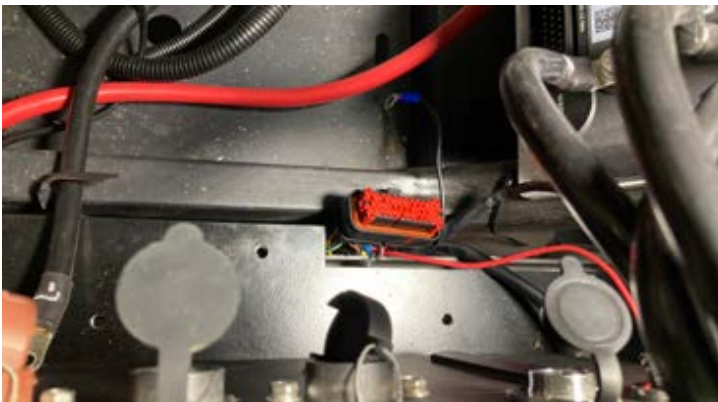

Pulling/pushing upward on the battery tray, you will be able to slide the 32-pin controller connector down between the frame and the battery tray. On the other side of the cart, you will repeat this to slide the fuse block down between the frame and the battery tray.



Once all the connectors have been moved down below the cart, you only have to cut and remove all the zip ties along the side frame rails, and disconnect the brake switch and throttle sensor. You will reverse these steps to complete the installation.



Basic Voltmeter Testing

To be a well rounded golf cart technician, you must become proficient in the use of a voltmeter. There is no better diagnostic tool that you can learn to use. Along with the meter itself, you need to have a selection of jumper wires, of different lengths. With these wires, you need an understanding of what they are capable of doing for you, along with knowing how to insulate them from touching unintended metallic objects.

You will also need to understand the various tests that can be done with a digital volt ohm meter (DVOM) and we'll cover those here. We will only discuss the digital type of meter, because they have a built-in impedance (resistance) that make it safer to use with computerized electrical systems. DO NOT use an analog meter with computerized vehicles. These are the meters with an oscillating needle that sweeps across an incremental scale.

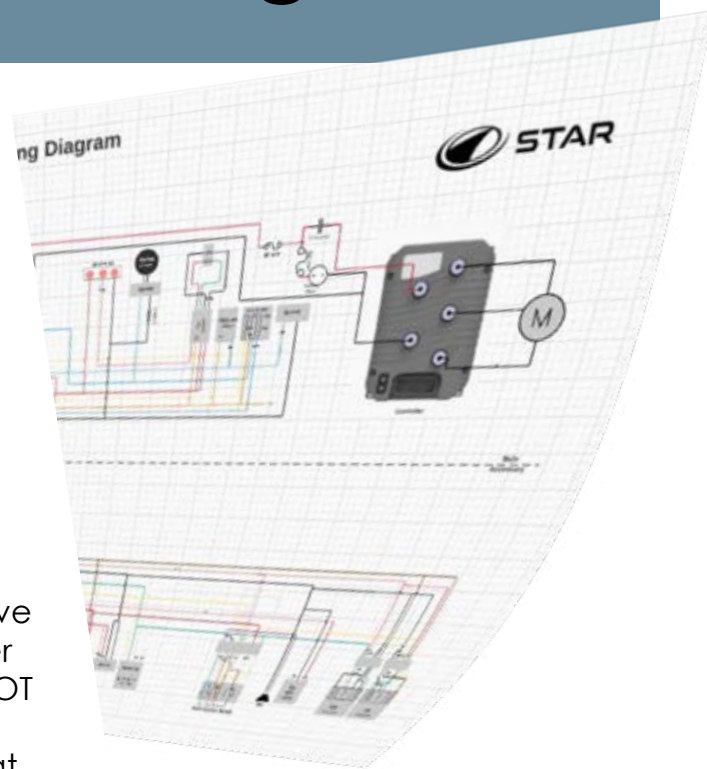

Table of Contents

Voltage Drop Testing	355
Continuity Testing	357
Resistance Testing	360
Amperage Testing	361

Voltage Drop Testing

Almost all tests that are performed with a voltmeter should be done with the power turned off for the circuit being tested. This is because the movement of power through the meter will cause the fuse to blow in most meters. This can limit the testing that you can do, to ones that can be done with a dead circuit. But many circuit problems occur when the circuit is live, and doing work. So how can testing be done in this situation?

This is where voltage drop testing comes in. A voltmeter is designed to measure DIFFERENCE. So when you measure across the main terminals of a battery, the meter is telling you the difference between the two terminal posts. Under the meter's voltage setting, it isn't limited by the amperage rating of the meter's internal fuse. This allows the meter to measure large amounts of difference with ease. So we can apply this capability to measuring live circuits.

Voltage drop measures how much voltage is lost across a complete circuit, or across a single part of a circuit, due to resistance. Every circuit has its own built-in amount of resistance. The longer the wire, and the more components involved, the more resistance accumulates. The problem is that additional resistance will always cause excessive voltage drop.

So let's take a look at an example. On a contactor, this would be way too much amperage to test with resistance, continuity, or amperage settings on the meter. But we can use voltage drop here. When testing across the main contactor terminals and the contactor disengaged, we should see full battery voltage. This is because we are measuring difference-difference of full battery volts on one side, waiting to flow across to the side that has zero. So the difference between 48V and zero, gives you 48V.



In the next scenario, we'll activate the contactor. The voltage is now flowing across a good connection. Think of this as a perfectly clean piece of wire, with an excellent connection at both ends. The power is able to flow freely across, so in essence there should be almost no difference between the volts flowing into and out of the connection. 48V should be going in, and if the connection is excellent, we should only lose a tiny bit of voltage across this bridge. In this photo, we only have .002V loss. This is a perfect example of a voltage drop test in action!

Now as with anything electrical, there can be all kinds of formulas that can come into play. But we need to keep things simple! Your time is extremely valuable, and you can't waste any of it. So let's think of resistance in a circuit. A resistor slows down the flow of electricity. In doing this, it changes the energy to heat. An example of this energy exchange is in an incandescent light bulb, where the filament actually glows red hot to light up a room.

Well, voltage drop measures the amount of difference across a resistance. If there's no resistance, then there's no difference. If there's huge resistance, then there's huge difference. A typical wire in good condition should have voltage drop in the millivolts range, along with practically any good connection.

On the other side of that same coin, the more that the good connection is degraded through resistance, the higher the voltage drop will become. So you can see how this test can be extremely useful in testing components throughout a circuit, to see which one is adding resistance where it shouldn't be. You can use this test across a connector as well. A good connection, through the connector, will have almost zero voltage drop, whereas corroded pins will increase the resistance, making the lost voltage higher. As long as you can get to both sides of any component, you can check the voltage lost across it.

There are some conditions that only occur when the circuit is "under load", active or "live". These issues wouldn't even be evident under "static" or dead testing. So voltage drop testing is crucial in diagnosing these types of concerns. The one thing to keep in mind, is that there are components that are supposed to add resistance, the main one being a resistor. But these are a known resistance value, and by using ohm's law you can account for the loss that happens across them. But another is a diode. A diode acts like a check valve to electricity. So depending on which direction you connect your leads, you will get different readings. It helps to keep these items in mind when testing, but they are rarely sources of issues unless they stop adding the resistance they're intended to.

Another thing to keep in mind, is that there are signal wires, that send digital or analog signals back to the controller so it can make decisions during operation. Voltage drop is intended to be used on the power or ground sides of circuits, not signal wires. It won't hurt the controller if you do, but the information the meter tells you will not be useful and can lead you to incorrect conclusions.

Continuity Testing

One skill that is extremely important to have, is knowing how to test for continuity. Continuity gives you the ability to quickly test the integrity of a wire, or circuit. With a continuity test, you can rule out complete sections of an electrical path, allowing you to focus your efforts on other components. The main thing to remember, when doing a continuity test, is that the circuit you're testing must be disconnected from power, or turned off. This will damage your meter, if there is power in the circuit.

Next, make sure you are using a digital multimeter, which has a numerical display. A digital meter has a built-in impedance that will protect your vehicle's components from damage, in the case your meter leads touch something they shouldn't. If your meter has a needle, that sweeps across a gage, it will damage computerized circuits!

Your meter's black lead should be in the in port labeled COM, and will have the V (Volts), Ω (Ohms), Hz % (Hertz or duty cycle) symbols. Your red lead will go into the red port, that does not have an "A" label. On our example meter, you will see the capacitor/diode/continuity symbols. The ports labeled with an "A" are for measuring Amperage and should not be used for this testing.



Now, set your meter's knob to the Ω symbol. This is allowing the meter to measure Ohms of resistance between the leads. The meter sends a small voltage from its battery, through the leads and records how much voltage returns to the meter. This is why we use ohms of resistance to measure continuity. To have continuity, you have a good path for electricity to travel through the circuit-which requires almost no resistance.

In the photo above, we have the tips of the two leads touching each other. The meter knob is set to Ohms (resistance), and the meter shows almost no resistance or good continuity. If you see the letters O.L. this means over limit, and there is an open circuit. This means there is no path for electricity to travel between the leads.





For ease of testing, many meters have an audible function for measuring continuity. This allows you to perform the test, without having to visually look at the display each time. You will be able to hear an audible tone, whenever there is good continuity. In the image shown, you will see the audible tone symbol on the display.



On our example meter, we can turn on the audible feature by pressing the Function button. But on some other meters, it may be the Select button. Refer to your meter's instruction manual if you are unsure about turning this feature on. You can still test for continuity, even if your meter doesn't have this option. You will just look at your display and verify that you have near-zero resistance. Either way, the test results are the same.

Here, we are testing across a short wire. Our meter is giving an audible tone, indicating a low resistance and lighting a visible LED at the top. These are all showing that our wire is good.



Here we're repeating the same test, with a longer wire. The meter is displaying all the same indicators, and sounding the audible tone. We can now know that our wire is good, and can move on to testing other wires or components. In the example of an encoder, we can use continuity testing to rule out broken wires from the controller to the encoder.

To test the wiring for an encoder, you will simply prepare your meter for measuring resistance, verify your leads are in the proper ports on the meter, and turn on the audible feature if your meter is equipped with one. Then, disconnect both ends of the wiring to be tested. In this example, you would unplug the encoder itself, and the connector from the controller. You are now ready to begin testing.

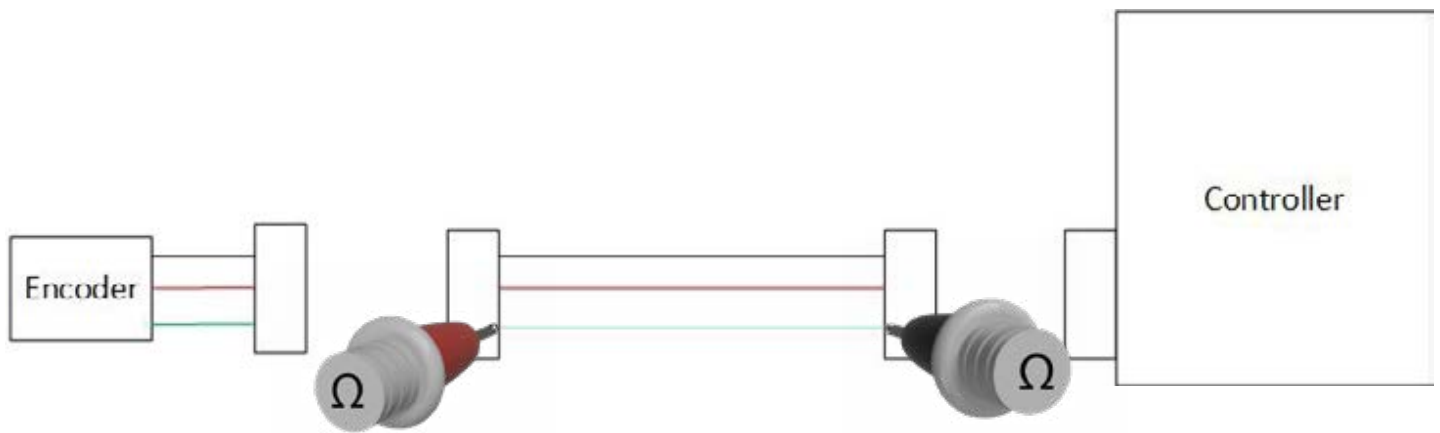

With this diagram, we are able to see that we are checking the continuity of the green wire. If there is a good electrical path, we will have good continuity or near-zero resistance. We should have an audible tone, if our meter has that option and it's turned on.

If these indicators are not present, you will want to record that the green wire is damaged and continue testing the other wires in the same connector. Record all wires that do not have continuity in the same connector. It is very possible that there are multiple wires that are damaged in the same connector or harness.

Once you have recorded which wire(s) are damaged or broken, you can inspect the harness between the two ends and you'll know exactly which wire will be bad from your testing. This can be the wires themselves, or even the pins that are in the connectors. So you will want to thoroughly inspect all the related parts of the wire(s) that tested bad.

If you have tested your wiring for continuity, and all have tested good, you can move on to testing your other components. You can rule out the wiring connecting them. This type of testing can be used to test any wiring in a vehicle, as long as the circuits are not being powered while doing the tests. You can quickly prove that wiring is good, and move to other specific tests. You will save yourself tons of time, with good continuity testing skills.

Resistance Testing

When testing for resistance, you are essentially doing the same test as continuity. The difference is that a continuity test is more like a pass/fail kind of test, whereas resistance is a more precise numerical value of the resistance measurement. Continuity just means that voltage can get through somehow. Where continuity falls apart, is in the instance where you have one strand of wire that is good, and all the others are broken. A continuity test will pass the wire, saying it has continuity.

A resistance test of the same section of wire, would show high resistance, because the electricity would have a hard time passing across just the single strand of wire. A voltage drop test could further confirm this, because there would be an increased difference across the strand.

Notice in the photo, the same meter setting will test resistance, continuity and diodes. This is because they're all the same. Resistance is just more precise. Because a diode is a one-way check valve for voltage, you would have continuity or low resistance in one direction, but the opposite in the other direction. On most meters, there is another button that will turn on the audible tone that signifies good continuity.

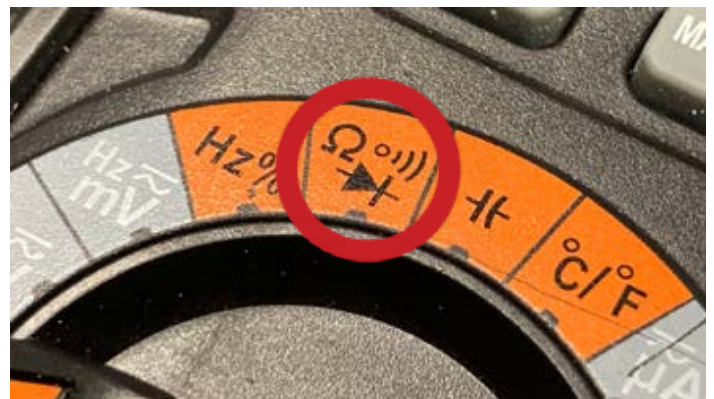

Due to the fact that these are all essentially the same tests, the leads should be in the same ports as all the other mentioned tests.

The main thing to remember when testing for resistance, is that the circuit must be OFF or dead! If you connect the meter to a live circuit, with the meter in resistance mode, then the meter becomes the path of least resistance, and all the volts will go through your meter, causing damage to the meter!



Amperage Testing

With amperage testing, it is critical that you keep several points in mind.

1. The circuit must be ON.
2. You must have some idea of the expected amperage you expect to encounter in the circuit.
3. You must change the meter leads to the ports that are rated for the expected amperage.
4. If the amperage is higher than 10A (amps) you will need to use either a low amp clamp or high amp clamp. Your meter fuse will blow if you exceed the rated amps of the port your leads are plugged into. An amp clamp goes around the power supply wire in a circuit, and converts the amperage to a usable reading by your meter. Follow the instructions for your particular amp clamp, for which ports to use with your meter. You will still need to know what kind of amperage you intend to measure with your clamp and if the amp draw fits within the rating of your clamp

Please note, there are also standalone amp clamps that don't require a meter to use them. They have their own digital displays, and no meter leads are needed.



In testing golf carts, the amperage setting is rarely used, simply because you can gather the same information using the other testing methods and the very small amperage ratings don't allow you to test very many circuits. When looking at the typical fuse box, the fuses are either 10A or 15A, indicating that most of the circuits draw just under these amperages. You can see that the meter capabilities would have a hard time testing any of these circuits without blowing its own, on board fuse.

Torque Specifications

Fastener	Description	Torque Spec	Tolerance
Steering Wheel	Socket Head Flat Screw M5x16	35.4in-lbs (4N.m)	±4.5in-lbs (±0.5N.m)
	Center Hex Nut M16x1.5	22.127ft-lbs (30N.m)	±2.21ft-lbs (±3N.m)
Front Roof Supports to Frame	Hex Head Bolt M10x30	37ft-lbs (50N.m)	±4ft-lbs (±5N.m)
Roof Support to Halo	Socket head flat round head M8x60	12ft-lbs (16N.m)	±3ft-lbs (±4N.m)
Seat to seat base	Hex socket flat round head screw M8x20	10.5ft-lbs (14N.m)	±1.5ft-lbs (±2N.m)
Roof Bolts	Side & rear hex socket flat round head M8x80	9ft-lbs (12N.m)	±4.5in-lbs (±0.5N.m)
	Front hex socket flat round head M8x110	9ft-lbs (12N.m)	±4.5in-lbs (±0.5N.m)
Roof Grab Handles	Phillips pan head screw M6x45	4ft-lbs (5N.m)	±9in-lbs (±1N.m)
Windshield	Phillips pan head screw M6x50	3ft-lbs (4N.m)	±4.5in-lbs (±0.5N.m)
Wheel lug nuts	Lug nut M12x1.25	60ft-lbs (80N.m)	±7.5ft-lbs (±10N.m)
Rear flip seat to mounting bracket	Seat back to bracket hex socket flat round head M8x50	18.5ft-lbs (25N.m)	±2.21ft-lbs (±3N.m)
	Footplate hex socket flat round head M8x35	18.5ft-lbs (25N.m)	±2.21ft-lbs (±3N.m)
	Footplate hex socket flat round head M8x30	18.5ft-lbs (25N.m)	±2.21ft-lbs (±3N.m)
	Lower mounting plate hex bolts M10x35	37ft-lbs (50N.m)	±4ft-lbs (±5N.m)
Steering column to floor	Hex bolts M10x35	37ft-lbs (50N.m)	±4ft-lbs (±5N.m)
Hip restraint mounting bolts	Hex socket flat round head screw	10.5ft-lbs (14N.m)	±1.5ft-lbs (±2N.m)

Fastener	Description	Torque Spec	Tolerance
Upper shock mounting bolts	Hex bolts M10x55	33ft-lbs (45N.m)	±2.21ft-lbs (±3N.m)
Lower shock mounting bolts	Hex bolts M10x55	33ft-lbs (45N.m)	±2.21ft-lbs (±3N.m)
Trailing arm front mounting bolts	Hex bolts M13x89	59ft-lbs (80N.m)	±4ft-lbs (±5N.m)
U-bolts	Hex flange face lock nut M10x1.5	37ft-lbs (50N.m)	±4ft-lbs (±5N.m)
Spindle Castle Nuts	M12x1.25	29.5ft-lbs (40N.m)	±2.21ft-lbs (±3N.m)
Side Mirrors	Phillips pan head screw M6x45	3.69ft-lbs (5N.m)	±9in-lbs (±1N.m)
Rear roof supports to frame	Hex bolts M10x70	32ft-lbs (43N.m)	±2.21ft-lbs (±3N.m)
Steering rack to chassis	Hex bolts M10x40	29.5ft-lbs (40N.m)	±4ft-lbs (±5N.m)
Control arm to chassis	Hex bolts M10x70	26ft-lbs (35N.m)	±2.21ft-lbs (±3N.m)
Pod seat to chassis	Hex bolts M10x70	26ft-lbs (35N.m)	±2.21ft-lbs (±3N.m)
Lead acid battery terminals	Hex nuts	95-105in-lbs	
Lithium battery terminals	Hex bolts	124-221in-lbs	

Glossary

Amp Draw-The amount of electrical force withdrawn from the battery over time, to perform work.

Backup Beeper-Signal beeper that indicates the vehicle driver intends to drive in reverse.

BMS-Battery management system. Circuit board inside the lithium battery that governs connections, charging, and safeguards.

CAN-Controller Area Network. This is a two way communication protocol that simultaneously provides inputs, outputs and feedback loops along an optimized network.

Contact-Solenoid capable of handling high amperage.

Controller-Programmable computer that controls motor function based on supplied inputs.

Converter-A drop down transformer that reduces a higher voltage to a lower one.

.CPF file-Configuration Parameter File. This is a database file that contains parameters for writing to a controller's programmable memory for future use.

Cotter Pin-Pliable metal pin

that is inserted through a castle nut, allowing the nut to be locked in place.

Encoder-Magnetically pulsed sensor for measuring speed and direction.

Halo-Rectangular roof support that provides a structure to join the roof to the roof supports.

HPD Fault-A controller fault that indicates certain inputs are out of spec, requiring the throttle pedal to be disabled.

Interlock-Switch that acts as a safety mechanism. The controller must have this input to proceed.

KSI-Key Switch Input

LSV-Low Speed Vehicle-Set of requirements that are set by the US Government, to operate at or below a certain speed.

Noise Generator (Noise Maker)-Electrical speaker that generates a tone based off CAN signal input. Used for LSV regulation compliance.

Over Current-An amount of current that exceeds the current limits within the controller.

Plotting-Charting points along a graph over a period of time.

Sequencing Fault-A controller fault indicating that inputs supplied to the controller at vehicle start-up, occurred in the wrong sequence.

Slip Gain-A gain adjustment (offset shift) in the controller, that allows it to account for manufacturing differences.

Spanner Wrench-A hook-toothed wrench, for tightening and loosening notched spanner nuts.

State of Charge-Amount of usable charge in a battery.

Supervisor Fault-

Termination Resistor-A measured amount of resistance that is intentionally made into a component.

Thermocouple/Thermistor-Temperature controlled switch.

Trickle Charging-Battery charging at low amperage for an extended period of time.

Under Current-

Table of tables

Fluids and Capacities Table	5
Bulbs and Lighting	5
Tire Pressures	8
Grease Points	8
Maintenance Intervals	9
2 Passenger Component Locations List	11
4 Passenger Component Locations List	13
Fuse Assignments	15
Paint Codes Chart	27
Thermistor Resistance Table	90
Throttle Sensor Testing Chart	91
Lester Summit II Charger Profiles Table	105
Charger LED Chart	130
Sirius SOC Display Chart	160
Lithium Range Testing and Amps Table	163
Lead Acid Date Chart	166
MCX Fault List	174
HPD/Sequencing Fault Inputs Table	191
Slip Gain Adjustment Table	197
Curtis Fault List	199
Converter Wire Color Designation Table	212
Alignment Specifications Table	263
Headlight Testing Chart	312
Turn Signal Testing Chart	313
Torque Specifications Chart	362

Index

- A**
App 99, 101-108, 120, 126, 128, 130-1, 138-149, 152, 154-5, 161
Arcing 101, 127
Alarm 174
Alignment 9, 59, 258, 260-1, 281, 284, 365
Amperage 354-5, 357, 361, 364
Axle 10, 233, 235, 254, 256-8, 260, 294, 297-302
- B**
Backing Plate 217, 235-6, 250-7, 294, 300-1, 304
Backup Beeper 11, 13, 335, 350, 364
Ball Joint 8, 270, 272-3, 289-90
Bleeding 218-9, 232, 255
BMS 9, 120-1, 125, 131, 145-6, 151-9, 364
Brake Lights 15, 315-6, 318
Brush Guard 27, 49-50
Bulbs 5, 365
BUZZER/GAUGE 129
- C**
Cable 9, 27, 29, 31, 39, 54-7, 79, 95, 97, 101, 113-6, 118-9, 121, 128, 151, 164, 167, 188, 217, 246-7, 250-1, 253, 256-7, 301, 304, 308-9
CAN Box 10, 120, 149, 151-2, 155
Caliper 217, 237-240, 242
Channel 22-3, 88-9, 209, 240-1, 272, 283, 285, 288, 291
Charger 4, 6, 10-4, 99-103, 105-15, 117-19, 122-3, 127-31, 149, 151, 155, 161, 167, 175, 190-3, 352, 365
Chassis 6, 10, 363
Check Engine Light
Cloning 176, 181, 186
Combination Switch 278, 307, 310, 312, 326-7, 330-1
Contactors 12-3, 174, 176, 194-6, 199-201, 203-11, 351, 355, 364
Continuity 83, 123, 310-12, 315, 317-8, 354-5, 357-60
- D**
Control Arm 258, 261-2, 268, 270-5, 283, 363
Controller 4, 12-3, 38-40, 77, 80-4, 87-91, 124, 163, 169-71, 173-7, 180-2, 184-5, 189-97, 199-201, 205, 207-11, 221, 227, 319, 321, 351, 353, 356, 358-9, 364
Converter 4, 12, 14, 193, 212-6, 307, 312, 316, 352, 364-5
Cruise Control 11, 13, 307, 319
Cupholder 13, 32-4, 51, 53, 124, 171, 223, 308, 319, 326, 335, 337, 339, 341, 345, 349
- E**
Emailing 176, 188
Encoder 13, 80-4, 87-9, 96, 175, 197, 199, 203, 208-10, 304, 358-9, 364
- F**
Fault 82, 87, 90-1, 122, 138, 144-5, 170-1, 174-7, 181, 190-4, 196, 199-211, 364-5
Firmware 171-3, 175
Flasher Relay 281
Fluids 5, 365
Folding Windshield 27, 60, 62
Forward/Reverse 192-3, 341
Frame 6, 9, 16, 20, 25, 39-40, 68, 71, 74-5, 92-3, 96-7, 115, 121, 199, 253, 261, 266, 273-5, 285-7, 318, 322, 334, 351-3, 362-3, 365
Fuse 4, 12-15, 200-1, 204, 212-3, 307, 312-3, 315, 352-3, 355, 361
Glove Compartment 6
Golf Bag 20, 23, 27, 43-7, 72-3
- H**
Halo 27-8, 65-6, 68, 70, 362, 364
Handheld Programmer 83, 87-8, 91, 163, 176-7, 181, 187-8, 190, 197, 221
Hazard Switch 347
Headlight 5, 27, 29-30, 51, 53, 55, 57, 193, 310, 312, 365
High Low Switch 307, 337, 339
High Temp Grease 303, 306
Histories 99, 107, 111
Hood 11, 27, 31, 34, 54-9, 307, 345, 350-1
Hood Release 31, 34, 54, 58, 307, 345, 350
Horn 11, 13, 307, 310, 322-3, 334, 350
HPD 176, 190-3, 206, 364-5
Hub 10, 233, 235, 241, 252, 254, 256, 289-90, 292-3, 297
Hub Puller 10, 252, 254, 256, 297
Hydraulic 192, 193, 217, 218, 233, 248, 252, 255, 258, 294
- I**
Input Shaft 94, 95, 98, 274, 280-1, 287, 305-6
Interlock 11-13, 91, 175, 190-3, 199, 205-10, 352, 364
Intermediate Shaft 8, 258, 274, 279, 280-1, 286-7
- J**
Jam Nut 219, 248-9, 259-60, 263, 284
Jumper 10, 121, 191, 193, 354
- K**
Key Switch 13, 120-1, 144, 167, 190, 192, 196-7, 212-3, 307, 332-3, 347, 364
- L**
Lead Acid 9, 95, 99, 120, 162, 164, 166, 363, 365
License Plate 5, 48
Lift Points 4, 7
Lithium 9, 10, 12, 14, 95, 99, 117, 120, 97-8, 100-2, 109, 115-6, 120-2, 124, 126-7, 129-31, 138, 141-2, 144-5, 153, 155-6, 160-3, 167, 218, 221, 363-5
Linkage 218-20, 225
Lug Nuts 254, 297, 301, 362
- M**
Maintenance 4, 8-10, 16, 149, 174, 365
Manual 3, 58, 83, 144, 165, 168, 208-9, 217, 229, 235, 245, 248, 256, 258, 266, 268, 277, 292, 294, 326, 329, 332, 347, 358
Master Cylinder 5, 13, 40, 217-21, 231-2
MCX 10, 169-71, 174, 365
Mirror 10, 61, 63, 68 313-4, 324-5, 363
Motor 4, 12-3, 77-87, 90-1, 95-8, 169-70, 173-5, 176-7, 180, 197, 199-200, 202-11, 221, 294, 304-6, 351, 364
- N**
Noise Generator 12, 14, 364
- O**
Oscilloscope 83
Outlet 15, 101, 108, 127-8, 130, 307, 337-9, 341, 343
Overcurrent 170-1, 174, 199, 201-2, 205
- P**
Paint Codes 257, 365
Parameter 83, 85, 169, 172, 175, 177-81, 189, 194, 197, 199-202, 205-7, 209, 211, 364
Phases 78, 80, 84, 85-6
Piston 219-21, 232
Plotting 176-7, 180, 364
Polarity 122, 127, 325, 334
Profiles 99, 102, 104-6, 365
Pushrod 218-21
- Q**
QDS 77
- R**
Rear End 95-7, 264-6, 294, 300-6
Receptacle 6, 74, 92, 99, 101, 122, 191, 193,

Index

- 352
 - Regen 170, 200-1
 - Reluctor 82, 197
 - Resistance 78-9, 90, 124, 200-1, 205, 312, 354-60, 364-5
 - Ride Height 258-60
 - Roof 9, 20, 25, 27, 36, 47, 51-2, 54, 61-71, 314, 325, 362-4
 - Roof Support 9, 20, 25, 27-8, 36, 47, 51-2, 54, 61-4, 66-71, 314, 325, 362-4
 - RPM 83-4, 169, 203, 208, 210
 - RTV 94, 125, 156, 159
- S**
- Sealed Lead Acid 9, 99, 113, 164
 - Seat 6, 16-27, 32, 35-42, 68, 70-2, 74, 165, 167, 171, 214, 222, 224, 226-8, 255, 259-60, 293, 297, 351, 353, 362-3
 - Seatbelt 18-9, 41-2, 71-2, 214, 351, 353
 - Severities 174
 - Sequencing 176, 190, 192-3, 206, 364-5
 - Shock 96, 171, 244, 258-9, 263, 267-9, 273, 303, 363
 - Shoe 217-8, 233-6, 238, 250-1, 253, 256, 297-300
 - Signal 5, 48, 61, 63, 68, 81-4, 87-9, 91, 122-4, 155, 171, 176-7, 191, 193, 197, 208-9, 276, 281, 307, 311, 313-4, 319, 321-2, 324, 326, 331, 356, 364-5
 - Slide Hammer 10, 252, 254, 256, 297, 300-1
 - Slip Gain 176, 197-8, 364-5
 - Smartphone 10, 102, 107, 138, 155
 - Snap Ring 10, 252, 254, 256, 297, 300-1
 - Spacer 65, 225, 230, 260, 296
 - Spanner 10, 259-60, 364, 366
 - Spindle 241, 258, 270, 273-4, 283-5, 288-93, 363
 - Steering 4, 8, 10, 16, 28, 31-2, 114, 124, 160, 162, 175, 226-7, 258, 274-7, 278-81, 284-7, 290, 326, 328-32, 345, 347-50, 362-3
 - Steering Rack 258, 274-5, 280-1, 285-7, 363
 - Steering Wheel 114, 258, 276-8, 280, 326, 331, 347, 362
 - Steering Wheel Adapter 276, 331
 - Supervisor Fault 176, 193, 364
 - Switch 11, 13, 31, 33-4, 91, 120-1, 130, 144, 161, 167, 175, 190-1, 192-3, 196-7, 200, 206, 208, 212-3, 224-5, 230, 246, 248-9, 267, 278, 307-8, 310, 312-3, 315, 317-9, 321, 326-7, 330-3, 337, 339-50, 352-3, 364
- T**
- Tag Bracket 27, 48
 - Temperature 90, 95, 98, 138, 144, 163, 174-5, 178, 199-202, 220, 304, 364
 - Termination Resistor 124, 364
 - Thermistor 13, 77, 80, 90, 96, 202, 364-5
 - Throttle Sensor 11, 13, 80, 91-4, 224-5, 296, 353, 365
 - Tie Rod End 258, 274, 283-5, 287, 289-90
 - Torque 4, 9, 10, 79, 164-5, 167-8, 170, 173-4, 200-2, 264, 266, 268, 276-7, 326, 362-3, 365
 - Trailing Arm 8, 258, 260, 264-6, 306, 363
 - Turn Signal 5, 48, 61, 63, 68, 276, 281, 307, 311, 313, 314, 322, 324, 326, 331, 365
- U**
- U-bolts 260, 265-6, 305, 363
 - Undervoltage 174, 200-1, 209
 - USB 15, 149, 151, 171, 188-9, 307, 343
- V**
- Voltage 80, 91, 99, 106, 120-2, 125-8, 130-1, 144, 160-1, 174, 180, 192-3, 195-6, 199-202, 204-5, 208-9, 212-3, 307, 312, 316-7, 354-7, 360, 364
 - Voltage Drop 195-6, 200-1, 354-6, 360
- W**
- Welded Contactor 176
 - Weld Check 194-6
 - Weldment 260, 306
 - Wheel 6, 8-9, 42, 68, 73, 76, 82, 113-4, 163, 197, 217-8, 220-1, 233, 235, 239-41, 243-5, 252, 254, 256, 258, 260, 262-4, 276-8, 280, 287-94, 297-9, 303, 322, 324, 326, 331, 334, 347, 362
 - Wheel Bearings 8, 9, 163, 221, 258, 288, 291
 - Windshield 27-8, 60-3, 67, 314, 324, 349, 362
 - Wiring Harness 16, 76, 92-3, 114, 124, 224, 279, 307, 314, 324-5, 327-9, 335-6, 349-50